

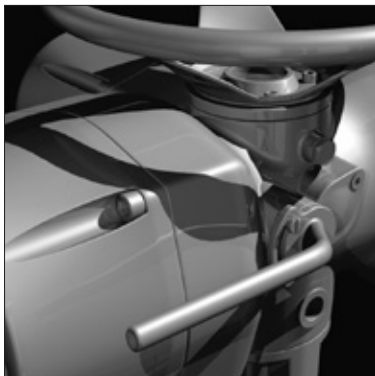
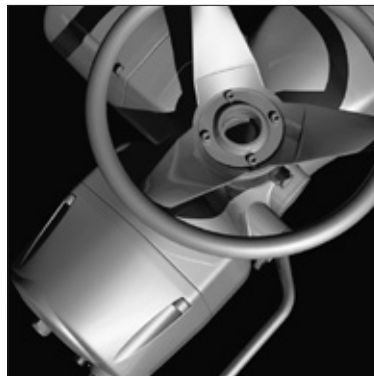

GENERAL INSTRUCTIONS FOR INSTALLATION

OPERATION AND CONFIGURATION

MAINTENANCE AND TROUBLESHOOTING

SPARE PARTS AND DRAWINGS

| | | |
|-----------|---|-----------|
| 5.5 | Lock of the 3-position selector | 15 |
| 5.6 | Remote control | 15 |
| 5.7 | Operating the ICON 2000 for the first time | 17 |
| 5.8 | Optional modules | 17 |
| 5.9 | Base card of the ICON 2000 v4 | 19 |
| 6 | Local controls | 20 |
| 6.1 | Description of the local operator interface | 20 |
| 6.2 | Configuration options | 23 |
| 6.3 | Entering the view mode | 24 |
| 6.4 | Entering the set-up mode | 24 |
| 6.5 | Exit from view and set-up modes | 24 |
| 7 | Set-up menu | 26 |
| 8 | View menu | 28 |
| 9 | Set-up routines | 30 |
| 9.1 | Actuator set-up | 30 |
| 9.2 | Valve data | 38 |
| 9.3 | Maintenance | 39 |
| 9.4 | Example of set-up routine | 41 |
| 10 | View routines | 42 |
| 10.1 | Actuator set-up | 42 |
| 10.2 | Name plate | 42 |
| 10.3 | Valve data | 42 |
| 10.4 | Maintenance | 42 |
| 10.5 | Example of view routine | 47 |
| 11 | Maintenance | 48 |
| 11.1 | Standard maintenance | 48 |
| 11.2 | Special maintenance | 48 |
| 11.3 | Lithium battery change | 49 |

INDEX

| | | | | | |
|----------|--|----------|----------|--|-----------|
| 1 | General safety instructions | 3 | 3.3 | Manual operation | 9 |
| 1.1 | Range of application | 3 | 3.4 | Mounting the actuator onto the valve ... | 10 |
| 1.2 | Safety instructions for installation in hazardous area | 3 | 3.5 | Electrical connections | 11 |
| 1.3 | Applicable standards and regulations ... | 4 | 3.6 | Removing the terminal board enclosure | 11 |
| 1.4 | Terms and conditions | 4 | 3.7 | Cable entries | 11 |
| 2 | Storage and pre-installation | 5 | 3.8 | Terminal board | 12 |
| 2.1 | Tests to be carried out when the actuator is received | 5 | 3.9 | Instructions for the explosion-proof enclosures | 12 |
| 2.2 | Storage procedure | 5 | 3.10 | Installation in environment with explosive dusts | 13 |
| 2.3 | Checks to be performed before installation | 6 | 4 | Lubrication | 13 |
| 3 | Installation | 6 | 4.1 | Lubrication inspection | 13 |
| 3.1 | Working condition | 6 | 5 | Operating the ICON 2000 | 14 |
| 3.2 | Coupling block: disassembly from the actuator | 6 | 5.1 | Operation by handwheel | 14 |
| | | | 5.2 | Electrical operation | 14 |
| | | | 5.3 | Local control | 14 |
| | | | 5.4 | Local indication | 14 |

| | | | | | | | | |
|--|---|-----------|---|---|-----------|---|---|-----------|
| 12 | Troubleshooting | 50 | 27 | Storage and pre-installation | 67 | 45 | Maintenance | 77 |
| 12.1 | The electronics do not switch on when powered..... | 50 | 27.1 | Storage procedure..... | 67 | 45.1 | Periodic inspections | 77 |
| 12.2 | DC output voltage not available at the terminals..... | 50 | 27.2 | Checks to be performed before installation..... | 67 | 45.2 | Dismantling and reassembling | 77 |
| 12.3 | The actuator does not work from remote controls | 50 | 28 | Installation | 67 | 45.3 | Repairs | 77 |
| 12.4 | The motor is very hot and does not start | 50 | 28.1 | Working condition..... | 67 | Addendum E c Ex de (ia) IIB T4 Gb / c Ex tb IIIC T135°C Db IP66/68 | | |
| 12.5 | The motor runs but the actuator does not move the valve | 51 | 28.2 | Identification of entry..... | 67 | 46 | Safety instructions | 78 |
| 12.6 | The manual override can't be engaged..... | 51 | 28.3 | Wiring | 68 | 47 | Instructions for right installation | 78 |
| 12.7 | The valve does not seat correctly..... | 51 | 28.4 | Cable connection | 68 | 47.1 | Marking | 78 |
| 12.8 | Excessive torque for valve operation..... | 51 | 28.5 | Installation in ambient with explosive dusts..... | 68 | 48 | Applicable directives, general standards and norms | 79 |
| 12.9 | The actuator does not stop in fully open or fully closed position | 51 | 29 | Maintenance | 69 | 49 | Terms and conditions | 79 |
| 12.10 | The numeric position display indicates "E01"..... | 51 | 29.1 | Periodic inspections | 69 | 50 | Manufacturer's liability | 79 |
| 12.11 | Diagnostic messages | 52 | 29.2 | Dismantling and reassembling | 69 | 51 | Storage and pre-installation | 79 |
| 13 | Parts list and drawings | 54 | 29.3 | Repairs | 69 | 51.1 | Storage procedure..... | 79 |
| 13.1 | Introduction..... | 54 | Addendum C c Ex d (ia) IIC T4 Gb / c Ex tb IIIC T135°C Db IP66/68 | | | 51.2 | Checks to be performed before installation..... | 79 |
| Addendum A c Ex de (ia) IIB+H2 T4 Gb / c Ex tb IIIC T135°C Db IP66/68 | | | 30 | Safety instructions | 70 | 52 | Installation | 80 |
| 14 | Safety instructions | 60 | 31 | Instructions for right installation | 70 | 52.1 | Working condition..... | 80 |
| 14.1 | General..... | 60 | 31.1 | Marking | 70 | 52.2 | Identification of entries..... | 80 |
| 14.2 | Identification of main parts | 60 | 32 | Applicable directives, general standards and norms | 71 | 52.3 | Electrical connections..... | 80 |
| 15 | Check for right application | 61 | 33 | Terms and conditions | 71 | 52.4 | Cable connection | 80 |
| 15.1 | Marking | 61 | 34 | Manufacturer's liability | 71 | 52.5 | Installation in ambient with explosive dusts..... | 80 |
| 16 | Applicable general standards and regulations | 61 | 35 | Storage and pre-installation | 71 | 53 | Maintenance | 81 |
| 17 | Terms and conditions | 61 | 35.1 | Storage procedure..... | 71 | 53.1 | Periodic inspections | 81 |
| 18 | Manufacturer's liability | 61 | 35.2 | Checks to be performed before installation..... | 71 | 53.2 | Dismantling and reassembling | 81 |
| 19 | Storage and pre-installation | 62 | 36 | Installation | 72 | 53.3 | Repairs | 81 |
| 19.1 | Storage procedure..... | 62 | 36.1 | Working condition..... | 72 | Addendum D c Ex de (ia) IIC T4 Gb / c Ex tb IIIC T135°C Db IP66/68 | | |
| 19.2 | Checks to be performed before installation..... | 62 | 36.2 | Identification of entries..... | 72 | 38 | Safety instructions | 74 |
| 20 | Installation | 62 | 36.3 | Electrical connections..... | 72 | 39 | Instructions for right installation | 74 |
| 20.1 | Working condition..... | 62 | 36.4 | Cable connection | 72 | 39.1 | Marking | 74 |
| 20.2 | Identification of entry..... | 62 | 36.5 | Installation in ambient with explosive dusts..... | 72 | 40 | Applicable directives, general standards and norms | 75 |
| 20.3 | Wiring | 63 | 37 | Maintenance | 73 | 41 | Terms and conditions | 75 |
| 20.4 | Cable connection | 63 | 37.1 | Periodic inspections | 73 | 42 | Manufacturer's liability | 75 |
| 20.5 | Installation in ambient with explosive dusts..... | 63 | 37.2 | Dismantling and reassembling | 73 | 43 | Storage and pre-installation | 75 |
| 21 | Maintenance | 64 | 37.3 | Repairs | 73 | 43.1 | Storage procedure..... | 75 |
| 21.1 | Periodic inspections | 64 | Addendum D c Ex de (ia) IIC T4 Gb / c Ex tb IIIC T135°C Db IP66/68 | | | 43.2 | Checks to be performed before installation..... | 75 |
| 21.2 | Dismantling and reassembling | 64 | 38 | Safety instructions | 74 | 44 | Installation | 76 |
| 21.3 | Repairs | 64 | 39 | Instructions for right installation | 74 | 44.1 | Working condition..... | 76 |
| Addendum B c Ex d (ia) IIB T4 Gb / c Ex tb IIIC T135°C Db IP66/68 | | | 40 | Applicable directives, general standards and norms | 75 | 44.2 | Identification of entries..... | 76 |
| 22 | Safety instructions | 65 | 41 | Terms and conditions | 75 | 44.3 | Electrical connections..... | 76 |
| 22.1 | General..... | 65 | 42 | Manufacturer's liability | 75 | 44.4 | Cable connection | 76 |
| 22.2 | Identification of main parts | 65 | 43 | Storage and pre-installation | 75 | 44.5 | Installation in ambient with explosive dusts..... | 76 |
| 23 | Check for right application | 66 | 43.1 | Storage procedure..... | 75 | Addendum E c Ex de (ia) IIB T4 Gb / c Ex tb IIIC T135°C Db IP66/68 | | |
| 23.1 | Marking | 66 | 43.2 | Checks to be performed before installation..... | 75 | 46 | Safety instructions | 78 |
| 24 | Applicable general standards and regulations | 66 | 44 | Installation | 76 | 47 | Instructions for right installation | 78 |
| 25 | Terms and conditions | 66 | 44.1 | Working condition..... | 76 | 47.1 | Marking | 78 |
| 26 | Manufacturer's liability | 66 | 44.2 | Identification of entries..... | 76 | 48 | Applicable directives, general standards and norms | 79 |
| | | | 44.3 | Electrical connections..... | 76 | 49 | Terms and conditions | 79 |
| | | | 44.4 | Cable connection | 76 | 50 | Manufacturer's liability | 79 |
| | | | 44.5 | Installation in ambient with explosive dusts..... | 76 | 51 | Storage and pre-installation | 79 |

1 GENERAL SAFETY INSTRUCTIONS

1.1 RANGE OF APPLICATION

ICON 2000 electric actuators covered in this I&O Manual are designed for the operation of any kind of industrial valves used in heavy industrial, chemical, petrochemical plants. Biffi will not be liable for any possible damage resulting from use in other than the designated applications. Such risk lies entirely with the user.

The noise emitted by the electric actuator in normal working conditions is less than 66 dB (A) with peak value 115 dB (C). Standard reference ISO 11202 (1st ed., 1995-12-15).

WARNING

It is assumed that the installation, setting, commissioning, maintenance and repair works are carried out by qualified personnel and checked by responsible specialists.

The electric actuators are designed in accordance with the applicable international rules and specifications but the following regulations must be observed in any case:

- The general installation and safety regulations.
- The plant specific regulations and requirements.
- The proper use of personal protective devices (glasses, clothing, gloves).
- The proper use of tools, lifting and transport equipment.

1.2 SAFETY INSTRUCTIONS FOR INSTALLATION IN HAZARDOUS AREA

WARNING

In case the electric actuator must be installed in an HAZARDOUS AREA, as defined by the local rules, it is mandatory to check if the nameplate of the electric actuator specifies the appropriate degree of protection. Maintenance and repair works must be carried out by qualified personnel and checked by responsible specialists.

ICONS are designed according to IEC/EN 60079-0, IEC/EN 60079-1, IEC/EN 50079-31 standards. Different types of protection are available, depending on the marking printed on the actuator label: Ex d IIB Txx, Ex d IIC Txx with "Explosion proof" terminal board enclosure, or Ex d e IIB Txx, Ex d e IIB+H2 Txx, Ex d e IIC Txx with "Increased safety" terminal board enclosure. They are suitable in hazardous area classified against the risk of explosion for the presence of gas and dust. Actuators have IP66/68 degree of protection according to EN 60529.

1.2.1 Marking

| | |
|-------------------|--|
| IECEx INE XX.ZZZZ | IECEx reference certificate (CoC) |
| XX ATEX ZZZZ | ATEX reference certificate |
| 0080 | Notified body for ATEX quality assurance (INERIS) |
| II | Group II (surface industries) |
| 2 | Category 2 apparatus |
| G | Explosive atmospheres caused by gas, mists or vapors |
| D | Explosive atmospheres caused by gas dusts |
| IP66/68 | Degree of protection |

| Hazardous zone | Zone | Categories according to 2014/34/EU Directive |
|----------------------|------|--|
| Gas, mist or vapors | 0 | 1G |
| Gas, mists or vapors | 1 | 2G or 1G |
| Gas, mists or vapors | 2 | 3G or 2G or 1G |
| Dust | 20 | 1D |
| Dust | 21 | 2D or 1D |
| Dust | 22 | 3D or 2D or 1D |

EQUIPMENT PROTECTION LEVEL (EPL) EN 60079-14

| Explosive atmosphere | Zone | EPL |
|----------------------|------|----------------|
| Gas | 0 | Ga |
| Gas | 1 | Ga or Gb |
| Gas | 2 | Ga or Gb or Gc |
| Dust | 20 | Da |
| Dust | 21 | Da or Db |
| Dust | 22 | Da or Db or Dc |

1.3 APPLICABLE STANDARDS AND REGULATIONS

| | |
|----------------|--|
| EN ISO 12100-1 | Safety of machinery - Basic concepts, general principles for design. Part 1-Basic terminology, methodology |
| EN ISO 12100-2 | Safety of machinery - Basic concepts, general principles for design. Part 2-Technical principles and specification |
| EN 60204-1 | Safety of machinery - Electrical equipment of industrial machines |
| 2006/42/EC | Machinery Directive |
| 2014/35/EU | Low Voltage Directive |
| 2014/30/EU | EMC Directive |
| 2014/34/EU | ATEX Directive |

1.4 TERMS AND CONDITIONS

Biffi guarantees each single product to be free from defects and to conform to current goods specifications. The warranty period is one year from the date of installation by the first user, or eighteen months from the date of shipment to the first user, whichever occurs first. No warranty is given for products or components manufactured by third-party companies, or for goods which have been subject to misuse, improper installation, corrosion, or which have been modified or repaired by unauthorized personnel. Repair work due to improper use will be charged at standard rates.

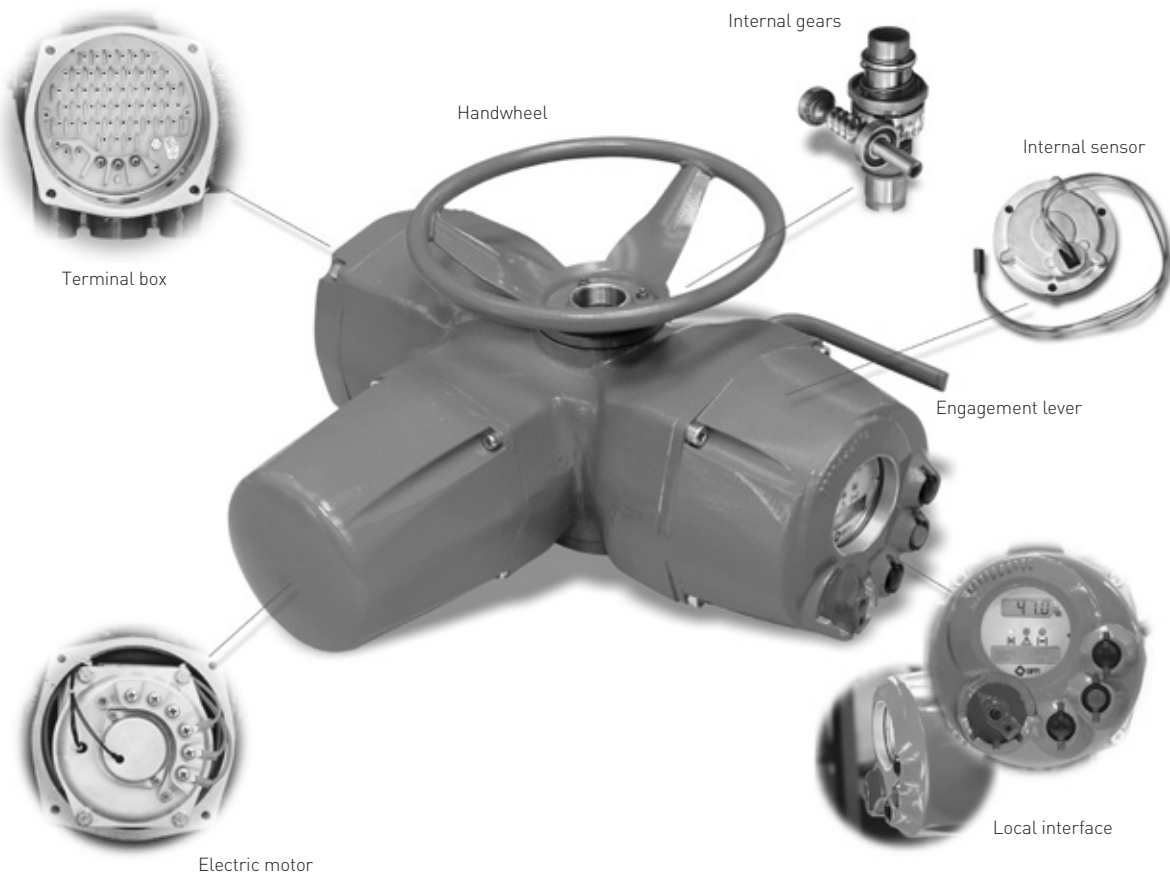

2 STORAGE AND PRE-INSTALLATION

2.1 TESTS TO BE CARRIED OUT WHEN THE ACTUATOR IS RECEIVED

If the actuator is received already mounted on the valve, all operations should have already been performed during valve/actuator assembly.

- Check that the display is active.
- Turn the handwheel until the valve is in a completely open position.
- Check that the display reads 100% indicating that the valve is completely open.
- Rotate the handwheel clockwise and bring the valve to a completely closed position.
- Check that the display reads 0% indicating that the valve is completely closed.

If the test result is satisfactory, the actuator has already been adjusted and you can proceed with the electrical connection.

If the actuator is delivered separately from the valve, or the above procedure shows that the position is incorrect, all operations described in this manual must be carried out.

- Check that no damage has occurred during transport, especially to the push-buttons, the display area glass and the selector.
- Check the information on the nameplate: serial number and performance data (nominal torque, operation speed, protection class, motor supply voltage, etc.), and verify the corresponding data on the display (see chapter 10, View routines).

Make sure all accessories have been received with the shipment, as described in the delivery documentation.

2.2 STORAGE PROCEDURE

IMPORTANT

Not performing the following procedures will invalidate the product guarantee.

2.2.1 General

The actuator leaves the factory in perfect condition, as guaranteed by an individual test certificate. In order to maintain these characteristics until the actuator is installed on site, proper procedures must be taken for preservation during the storage period. Biffi actuators are weatherproof to IP66/68. This condition can only be maintained if the units are correctly installed/connected on site and if they have been correctly stored. The standard plastic plugs used to close the cable entries are not weatherproof, they just prevent the entry of undesired objects during transport.

2.2.2 Storage for a brief period (less than one year)

2.2.2.1 Indoor storage

- Make sure that the actuators are kept in a dry place, laid on a wooden pallet and protected from dust.

2.2.2.2 Outdoor storage

- Make sure that the actuators are protected from the direct action of weather agents (protection by a canvas tarp or similar cover).
- Place the actuators on a wooden pallet, or some other raised platform, so that they are not in direct contact with the ground.
- If the actuators are supplied with standard plastic plugs, remove them from the cable entries and replace them with weatherproof plugs.

2.2.3 Long period storage (more than one year)

2.2.3.1 Indoor storage

(In addition to the instructions at paragraph 2.2.2.1)

- If the actuators are supplied with standard plastic plugs, replace them with weatherproof plugs.
- In case the actuator is provided with a lithium battery, remove it and store in dry and clean place (see paragraph 11.3, Maintenance - Lithium battery change).

2.2.3.2 Outdoor storage

(In addition to paragraph 2.2.2.2)

- Check the general conditions of the actuator, paying particular attention to the terminal board and local display glass.
- In case the actuator is provided with a lithium battery, remove it and store in dry and clean place (see paragraph 11.3, Maintenance - Lithium battery change).





2.3 CHECKS TO BE PERFORMED BEFORE INSTALLATION

- Make sure the valve to be motorized is the appropriate one for coupling to the actuator.
- The electrical supply cables must be suitable for the power rating (see the test certificate that comes with the actuator).
- Gather the right tools for the assembly and for setting the actuator controls.

If a long storage period has occurred, before reinstalling the actuator, please:

- Check the status of the O-ring seals.
- Check the installation of the plugs or cable glands on the cable entries.
- Check whether the enclosure covers or the actuator body are cracked or broken.
- Check the oil level in the actuator and top up if necessary.
- Put the batteries back into place (see paragraph 11.3, Maintenance - Lithium battery change).

3 INSTALLATION

3.1 WORKING CONDITION

The standard actuators are suitable for the following environment temperatures:
 -30°C +85°C (-22°F to +185°F)
 Special versions are available for extreme environment temperatures:
 -40°C +70°C (-40°F to +158°F)
 -55°C +70°C (-67°F to +158°F)

Note: only for Ex d or Ex d e versions, for ambient temperature range, see the specific attached addendum.

IMPORTANT

Check the "temperature environment range" embossed on the nameplate, for the correct utilisation with respect to the environment temperature.

3.2 COUPLING BLOCK: DISASSEMBLY FROM THE ACTUATOR

The bushing is delivered already assembled to the drive sleeve, even when it is unmachined. In order to perform the necessary machining, remove the bushing from its housing. Remove the fixing screws from the coupling block.

Actuator view from the coupling side, with the block separated from the gearbox. Do not lose the seal ring between the coupling block and the gear reduction unit.

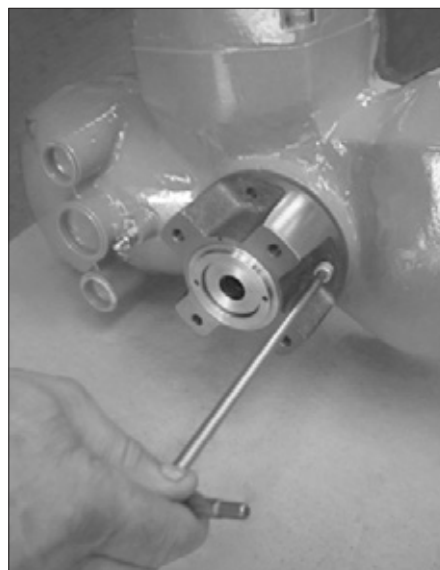

3.2.1 Type "A" coupling block
3.2.1.1 Preparing the bushing

With a compass key, unscrew the lower ring nut.

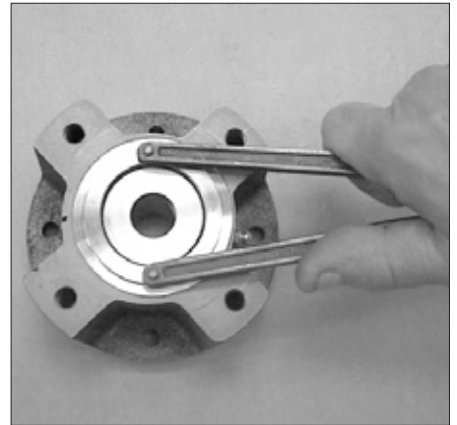
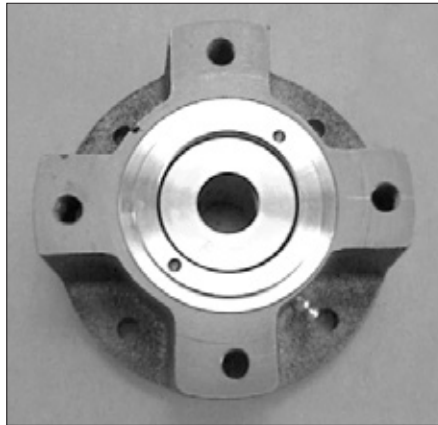

Extract the stem nut from the block housing.
The internal thrust bearing will remain at the bottom of the block housing.

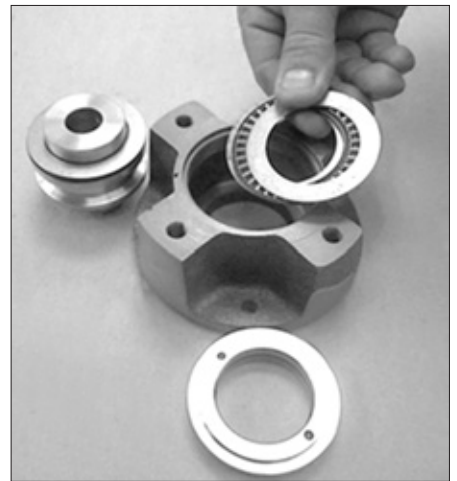

IMPORTANT

Before re-mounting the stem nut, make sure the coupling tolerances to the valve stem are correct. The threaded stem nut must be checked either with a thread gauge or with the stem of the valve to be motorized by screwing it all along the valve stem without excessive friction.

Now the bore can be machined in the stem nut to suit coupling requirements.
The same procedure is also used for possible maintenance.

3.2.1.2 Re-assembling the internal parts

It is advisable to wash the dismantled parts with a suitable solvent; dry them with compressed air; make sure there are no metal filings or foreign bodies; spread a film of grease on all parts (for grease type, see chapter 4, Lubrication).

Proceed with the assembly of the internal parts following the reverse order of the disassembly; tighten the lower ring nut with thread sealant LOCTITE 270 or equivalent, making sure the stem nut still rotates freely; fix the unit to the gear reducer as described further on.



3.2.2 Type "B1" and "B2" coupling blocks

3.2.2.1 Preparing the bushing

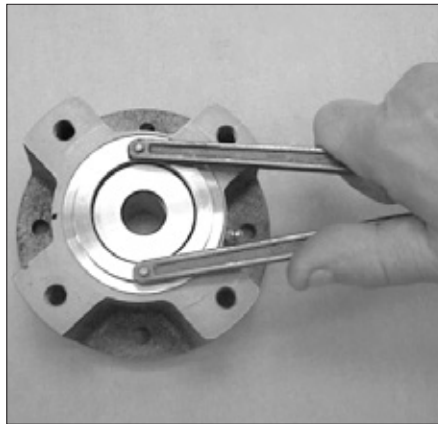
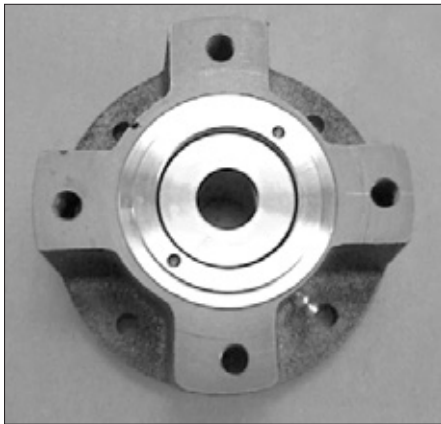

With a compass key, unscrew the lower ring nut.

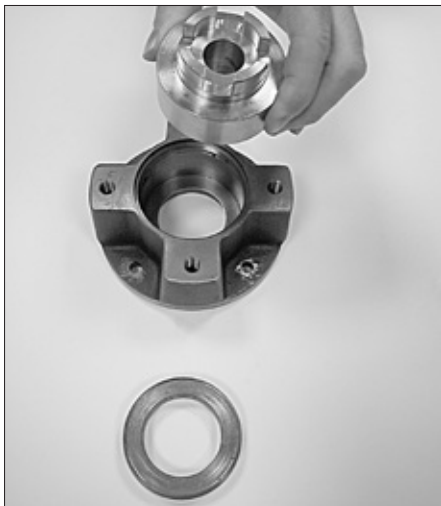

Extract the bushing from the block housing.

The internal thrust washer will remain at the bottom of the block housing.

Now the bore can be machined in the bushing to suit coupling requirements.

The same procedure is also used for possible maintenance.

3.2.2.2 Re-assembling the internal parts

It is advisable to wash the dismantled parts with a suitable solvent; dry them with compressed air; make sure that there are no metal filings or foreign bodies; spread a film of grease on all parts (for grease type, see chapter 4, Lubrication).

Proceed with the assembly of the internal parts following the reverse order of the disassembly; tighten the lower ring nut with thread sealant LOCTITE 270 or equivalent, making sure the bushing still rotates freely; fix the unit to the gear reducer as described further on.

3.2.3 Type "B3" and "B4" coupling blocks
3.2.3.1 Preparing the bushing

Remove the fixing screws of the coupling flange.

Remove the flange and the bush.



Remove the carbon steel thrust ring.



Extract the bushing and machine it according to the mating needs.

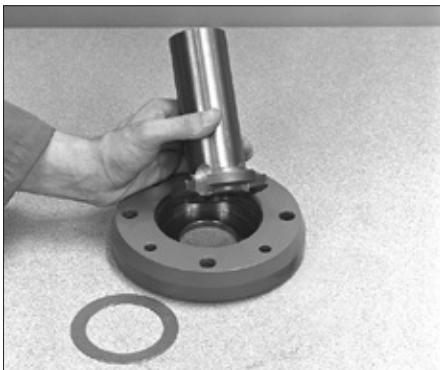

3.2.3.2 Re-assembling the internal parts

It is advisable to wash the dismantled parts with a suitable solvent; dry them with compressed air; make sure there are no metal filings or foreign bodies; spread a film of grease on all parts (for grease type see chapter 4, Lubrication).

Proceed with the assembly of the internal parts following the reverse order of the disassembly. Fix the unit to the gear reducer as described further on.

3.2.4 Fixing the coupling block to the gear reduction unit

Check the integrity of the O-ring seal and place it in its slot on the coupling block. Make sure the lugs of the drive sleeve fit in the correct slots on the bushing.

Fix the screws previously removed.

3.3 MANUAL OPERATION

To engage manual operation, depress (by 20°-30°) the lever in the direction shown on the photo. Then let the lever automatically return to its rest position. If no engagement is obtained, slowly rotate the handwheel and repeat the operation.

Rotate the handwheel to obtain the desired operation (normally clockwise rotation to close the valve).

A label is foreseen on the handwheel with an arrow showing the closing direction (clockwise by default). In case the closing direction is counterclockwise the label must be removed and re-mounted upside down.

WARNING

Do not manually operate the actuator with devices other than the handwheel and the declutch lever. Using cheater bars, wheel wrenches, pipe wrenches, or other such devices on the actuator handwheel or declutch lever may cause serious personal injury and/or damage to the actuator or valve.



Engagement lever locked in motor operation position: the manual operation cannot be engaged, and this excludes unwanted local operations.



Engagement lever locked in handwheel operation position: the operation with electric motor is mechanically disengaged.



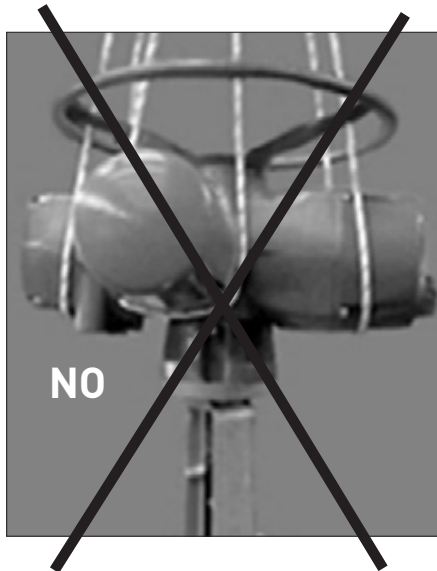
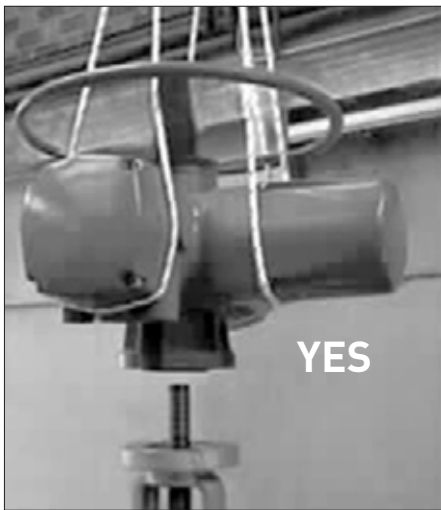

| Size (DN) | Max. weight (kg) |
|-----------|------------------|
| 010 | 32 |
| 020 | 38 |
| 030 | 46 |
| 040 | 56 |
| 050 | 73 |

WARNING

Never lift the valve/actuator assembly without securing slings to both the valve and the actuator.

WARNING

Never use the handwheel to lift the actuator.

3.4 MOUNTING THE ACTUATOR ONTO THE VALVE

Lubricate the valve stem.

Thoroughly clean the coupling surfaces of the valve and actuator flanges, degreasing them carefully since torque is transmitted by friction.

Lift the actuator with slings suitable for its weight.

The actuator will operate satisfactorily in any position. When mounted upside down, the end of the stem cover tube should be drilled $\varnothing 5$ mm to avoid build up of service fluid or rainwater.

3.4.1 Coupling type "A"

Place the actuator vertically on the stem, screw the threaded bushing of the coupling block on the valve stem, rotating (normally counter-clockwise) until the coupling block and flange surfaces of the valve are securely in contact. For safety purposes, rotate the handwheel in the opening direction for about two turns



in order to lift the valve gate from its seat to avoid (during bolt fixing) excessive axial thrusts on the internal parts of the valve and of the actuator.

Depending on the conditions of assembly, it could be easier to separate the thrust block from the actuator and mount it onto the valve yoke.

3.4.2 Couplings type "B1", "B2", "B3" and "B4"

Check the dimensions of the valve mounting details, paying particular attention to the protrusions of the valve stem in order to avoid any axial thrusts to the internal parts of the actuator or the valve when the screws are tightened.

Engage the manual operation. Place the actuator vertically on the valve stem. Carry out the coupling operations (if necessary with the help of manual operation); make sure no mating parts are forced.

3.4.3 Actuator fixing

IMPORTANT

In case the actuator is supplied without stud bolts and nuts the following materials must be used as a minimum:

- ISO class 8.8 for studs bolts and nuts
- or
- ASTM A 320 Grade L7 (or L7M) for studs bolts
- ASTM A 194 Grade 4 for nuts

| Model | Tightening torque (Nm) |
|-------|------------------------|
| 010 | 40 |
| 020 | 150 |
| 030 | 150 |
| 040 | 300 |
| 050 | 150 |

3.5 ELECTRICAL CONNECTIONS

Before powering the actuator check that the supply voltage details on the nameplate are correct for the plant. Access to terminals for electrical connections and commissioning is through the terminal cover, since all settings are non-intrusive. The removal of any other covers without Biffi's approval will invalidate the warranty. Biffi will not accept any responsibility for any damage or deterioration that may be caused.

IMPORTANT

*All the accessories (in particular cable glands) must be certified.
As of 30 June 2003, the above accessories must carry the CE certification conforming with 94/9/CE Directive.*

3.5.1 Plants requirements

Protection devices (overcurrent breakers, magneto-thermal switches or fuses) should be provided on the plant at Customer care, to protect the mains line in case of motor overcurrent or loss of insulation between phases and earth.

3.6 REMOVING THE TERMINAL BOARD ENCLOSURE

Using a 8 mm Allen key, loosen the four screws and remove the cover.

WARNING

Do not damage the mating surface of the cover.

IMPORTANT

In case the screws of the cover must be replaced, a SS AISI 316 must be used with minimum yield strength of 450 N/mm².

3.7 CABLE ENTRIES

The sealing of cables and conduit entries should be carried out in accordance with National Standards or the Regulatory Authorities that have certified the actuators. This is particularly true for units that are certified for use in hazardous areas where the method of sealing must be to an approved standard, and cable glands, reducers, plugs and adapters must be approved and separately certified.

Certified cable entries:

- Standard Rc ISO7/1
(cable entries 2x1" + 1x1 1/2" + (optional) 1x3/4" + (optional) 1x1 3/4")
- Standard ASA/NPT
(cable entries 2x1" + 1x1 1/2" + (optional) 1x3/4" + (optional) 1x1 3/4")
- Metric BS 3643
(cable entries 2xM32+1xM40)
- Pg DIN 40430
(cable entries 2xPg21+1xPg29)

Remove the cable entry plugs.

WARNING

- *The cable reducers are certified according to the actuator certification.*
- *Refer to the actuator drawing.*

IMPORTANT

- *To prevent any water infiltration through the line cable conduits, make sure the cable glands have the minimum protection degree required by the plant.*
- *If rigid conduits are used, we suggest placing a flexible pipe connection between the conduit and the terminal board.*

To guarantee weatherproof and explosionproof fit, screw the cable glands tightly (at least 5 turns) and block them with a thread sealant. The use of a thread sealant is necessary in case of explosionproof and weatherproof application.



If some parts of the cable glands have been removed while working on the cable entries put them back into place now to avoid losing the dismantled parts.

Unused entries:

- For explosionproof construction: unused entries must be plugged with metal explosionproof plugs and blocked with a thread sealant.
- For weatherproof construction: replace the plastic standard protection plugs supplied with the actuator with metal plugs.



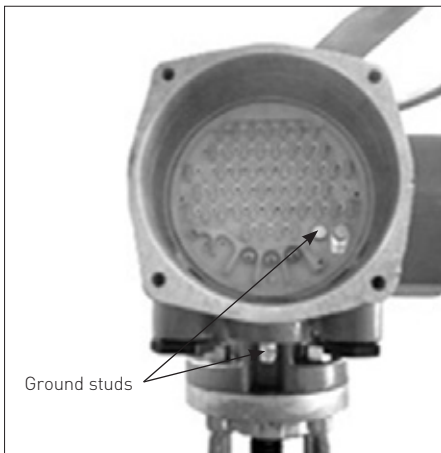

Ground studs



3.8 TERMINAL BOARD

IMPORTANT

The removal of any other covers without Biffi's approval will invalidate the warranty. Biffi will not accept any responsibility for any damage or deterioration that may occur as a result of cover removal.

Terminate the ground connections to the ground stud . One internal and one external ground studs are provided. Check the wiring diagram (always enclosed with the actuator) and the layout displayed

on the back of the terminals enclosure cover, to ensure a correct electrical connection. All terminations should be made by insulated ring or spade connectors using the appropriate crimping tool. This operation will ensure easy and correct electrical connection.

Connect the motor supply cable previously sized in accordance with:

- The absorbed current correspondent to the actuator nominal torque with the torque limiting device set at 100 percent (see the test certificate attached to the actuator).
- The applicable plant and safety norms.

Assemble the power terminals protective barrier, located in the terminal board compartment, using the enclosed screws. The control circuit (controls and signals) must be connected by means of a multicore cable to the corresponding numbered terminals according to the wiring diagram. The internal cables of the actuator are also numbered according to the wiring diagram. Actuators are always delivered with the motors wound and connected in accordance to customer requests. Voltage and frequency values are stated on the motor name-plate.

3.9 INSTRUCTIONS FOR THE EXPLOSIONPROOF ENCLOSURES

IMPORTANT

Electric actuator ICON 2000 shall be installed and maintained according to the applicable rules regarding the electrical installations in hazardous area (other than mines) classified as zone 1 (gas); example: EN 60079-10 (hazardous area classification), EN 60079-14 (electrical installation), EN 60079-17 (maintenance), and/or other national standards.

During the dismantling and subsequent reassembling of the explosionproof enclosures (covers, cable glands, joints) be careful to bring these enclosures back to their original condition to maintain their integrity. In particular, be sure the joint surfaces of all enclosures are spread with a film of recommended grease (see chapter 4, Lubrication).

So please:

- Do not damage the explosionproof mating surfaces on the housing and on the electrical enclosures covers.
- Reinstall all the screws that go with the dismantled parts, and block them with a thread sealant after spreading them with a film of copper- or molybdenum-based grease. This will keep screws from sticking and make maintenance operations easier.
- Check that the bolts and screws are the same dimension and quality as the original ones (as stated on the nameplate), or of a better quality.

WARNING

Do not operate the actuator electrically when the electrical enclosures are removed. Operating the unit with the electrical enclosures removed could cause personal injury.

- Replace the weatherproof seals that may have been removed (O-ring for the covers, O-ring for the explosionproof joint of the motor).

| Model | Motor cover | Terminal enclosure/local interface covers | | Material |
|-------|-------------|---|--|----------|
| | | Motor cover | Terminal enclosure/local interface covers | |
| 010 | M8x25 | M10x30 | AISI 316/ASME B16.11 A182-F316 (yield strength ≥ 450 N/mm ²) | |
| 020 | M8x25 | M10x30 | AISI 316/ASME B16.11 A182-F316 (yield strength ≥ 450 N/mm ²) | |
| 030 | M10x30 | M10x30 | AISI 316/ASME B16.11 A182-F316 (yield strength ≥ 450 N/mm ²) | |
| 040 | M10x30 | M10x30 | AISI 316/ASME B16.11 A182-F316 (yield strength ≥ 450 N/mm ²) | |
| 050 | M12x45 | M10x30 | AISI 316/ASME B16.11 A182-F316 (yield strength ≥ 450 N/mm ²) | |

3.10 INSTALLATION IN ENVIRONMENT WITH EXPLOSIVE DUSTS

IMPORTANT

Electric actuator ICON 2000 shall be installed and maintained; according to the applicable rules regarding the electrical installations in hazardous area (other than mines) classified as zone 21 (dust); example: EN 50281-1-2 (dust) and/or other national standards.

Please make sure that:

- The joint surfaces are greased with silicone oil or equivalent before assembly.
- The cable glands have minimum protection degree IP6X (EN 60529).
- Periodically verify the quantity of dust deposited on the enclosure and clean it if more than 5 mm.

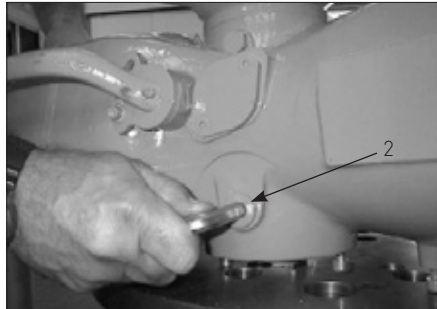
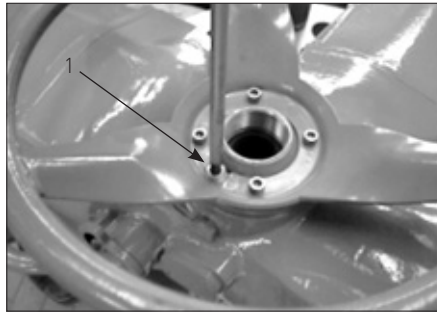

4 LUBRICATION

4.1 LUBRICATION INSPECTION

The actuator is lubricated for life, therefore under normal working conditions it is not necessary to replace or refill the oil. However it is recommended to check the oil level every 3-5 years using holes 1 or 2 depending on mounting position.

The actuator is fitted with oil plugs (parts 1, 2), so that any assembly on the valve has at least one oil plug on the upper part of the housing and one on the lower part.

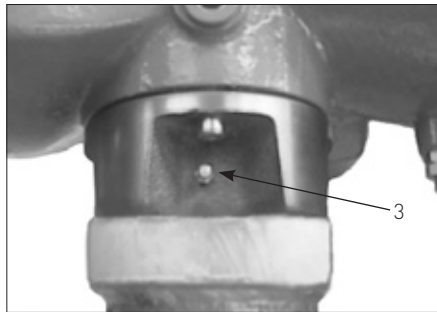

A spherical head lubricator (part 3) is fitted on the coupling block for the proper greasing of the inside thrust or sliding bearings.

The actuator is supplied with oil and greased where necessary.

| Actuator size (DN) | Oil quantity (l) |
|--------------------|------------------|
| 010 | 0.5 |
| 020 | 0.8 |
| 030 | 1.3 |
| 040 | 1.8 |
| 050 | 2.5 |

In case of maintenance the following OILS are recommended:

Ambient temperature from -30°C to +85°C (-20°C to 65°C for Ex d e version only)

- SHELL - TIVELA OIL SC320
- Other equivalent:
- EXXON TERESSTIC SHP320
- MOBIL OIL - GLYGOYLE HE 320
- KLUBER LUBRICATION - KLUBERSYNTH EG4-320

Ambient temperature from -55°C to +65°C

- SHELL - CASSIDA FLUID HF68
- Other equivalent:
- SYNECO - WINTER PLUS

In case of maintenance the following GREASES are recommended:

Ambient temperature from -30°C to +85°C (-20°C to 65°C for Ex d e version only)

- ISO viscosity grade X1 (EP1)
- Other equivalent:
- ESSO BEACON EP1
- AGIP GR MU/EP1

Ambient temperature from -55°C to +65°C

- FUCHS FN20
- Other equivalent:
- TEXACO low temperature grease EP
- AGIP FN20/00

5 OPERATING THE ICON 2000

5.1 OPERATION BY HANDWHEEL

To operate the actuator by handwheel, press the lever and at the same time rotate the handwheel until the clutch is engaged. Release the lever and move the valve by handwheel. The actuator will return to electrical operation only by energizing the motor.



WARNING

Do not manually operate the actuator with devices other than the handwheel and the declutch lever. Using cheater bars, wheel wrenches, pipe wrenches, or other such devices on the actuator handwheel or declutch lever may cause serious personal injury and/or damage to the actuator or valve.

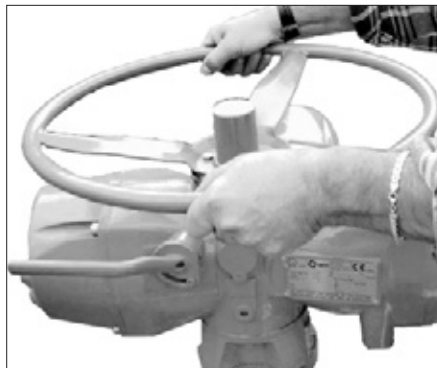

5.2 ELECTRICAL OPERATION

Before connecting power to the actuator check that the voltage is correct and according to the indications on the nameplate. Wrong power supply could cause a permanent damage to the electrical components. Check of phase rotation is not necessary since the unit is provided with automatic phase rotation correction. Place the 3-position selector in OFF and then switch on the power. Do not operate the actuator without first checking that the configuration is according to the required application. Using the "VIEW and SET-UP" features can do this (see paragraph 6.4, Local controls - Entering the set-up mode).



5.3 LOCAL CONTROL

After configuring the actuator, if no alarm is present, place the 3-position selector in LOCAL and control the actuator by OPEN, CLOSE and STOP push-buttons.

If "push-to-run" was selected the actuator can be driven to the desired position by pressing and holding the OPEN/YES or CLOSE push-button. As the push-button is released, the motor is de-energized.

If "latched" was selected, as the OPEN or CLOSE push-button is pressed the motor is energized, and it runs on after the control is released. To stop the motor, press the STOP push-button. To reverse the direction, press the STOP push-button and then press the push-button relevant to the opposite direction.

In "latched with instant reverse" mode, the local controls work as in the "latched" mode, but to reverse the motor direction you only need to press the push-button relevant to the opposite direction.

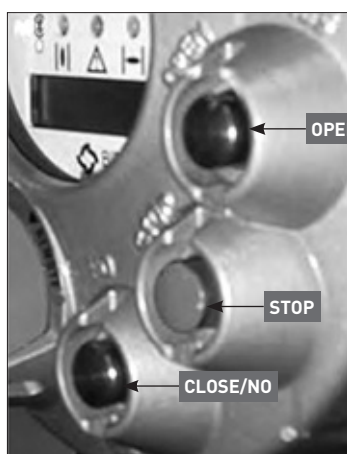

According to the position of the local selector, the OPEN/YES and CLOSE/NO push-buttons work as follows:

- Open/Close commands if the selector is in Local position.
- Yes/No, to answer prompts in the menu, if the selector is in Off or Remote positions.

5.4 LOCAL INDICATION

The upper display indicates the valve position as a percentage of opening (open = 100%). The lower display has two alphanumeric lines. The upper line indicates the actuator status and the 3-position selector status. The lower line indicates the actuator operation, or the position request % value, according to the configuration. Two LED's indicate the actuator position/operation, while a third LED indicates alarms.



Status Operation or Position request R% Local selector position



5.5 LOCK OF THE 3-POSITION SELECTOR

The 3-position selector can be locked in any of its three positions by means of a padlock.

5.6 REMOTE CONTROL

Place the 3-position selector in REMOTE to transfer the actuator control to a remote device. Local OPEN or CLOSE operation will be inhibited. Only local STOP control remains active.

Using the "VIEW and SET-UP" features may configure different control modes. The remote controls are opto-coupled.

A non-regulated 24 V DC voltage (variable from 23 to 27 V DC, max. 4 W) is available on the actuator terminal board to supply the remote controls or external devices.

5.6.1 Remote commands

Using the "VIEW and SET-UP" features may configure different control modes.

4 WIRES (see the remote connections diagram shown beside)

In "4 wires latched" (OPEN, CLOSE, STOP, COMMON) mode, with the OPEN or CLOSE signal switched to ON, the motor is energized, and it runs on after the signal returns to OFF. To stop the motor, press STOP. To reverse the direction, press STOP and then press the button relevant to the opposite direction. The action of the STOP signal (stop with signal ON or stop with signal OFF) may be reversed using the VIEW and SET-UP features, see paragraph 9.1.4, Remote controls.

3 WIRES (see the remote connections diagram shown beside)

With option "3 wires" (OPEN, CLOSE, COMMON), the actuator can be driven in either "push-to-run" or "latched with instant reverse" mode.

In "push-to-run" mode, the actuator can be driven to the desired position by switching the OPEN or CLOSE signal to ON. As the signal returns to OFF, the motor is de-energized. In "latched with instant reverse" mode, when the OPEN or CLOSE signal switches to ON, the motor is energized, and it runs on after the signal returns to OFF. If the signal relevant to the opposite direction goes ON, the actuator reverses its direction and maintains the new direction also if the signal returns to OFF.

2 WIRES (see the remote connections diagram shown beside)

With the "2 wires" option 2 different activities may be selected:

In "2 wires, signal ON to open", the actuator opens if the signal switches to ON and closes if the signal goes to OFF. In "2 wires, signal ON to close", the actuator closes if the signal switches to ON and opens if the signal switches to OFF. This option requires two wires (signal and common).

The circuits associated to the inputs can be supplied by the internally-generated 24 V DC or by an external 20-125 V DC or 20-120 V AC (50/60 Hz).

The signal levels are the following:

- Minimum ON signal > 20 V DC or 20 V AC (50/60 Hz).
- Maximum ON signal < 125 V DC or 120 V AC (50/60 Hz).
- Maximum OFF signal < 3 V.
- Minimum signal duration > 500 ms.
- Total current drawn from remote controls < 25 mA.

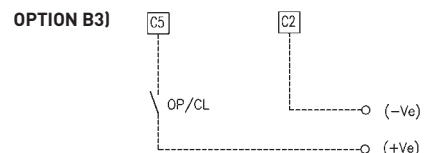
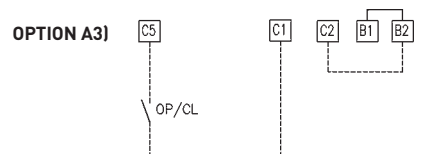
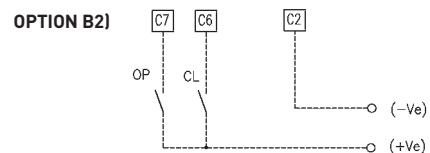
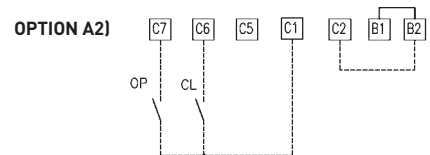
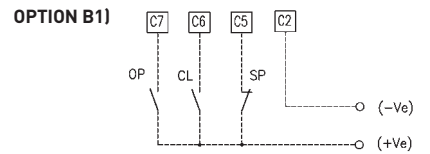
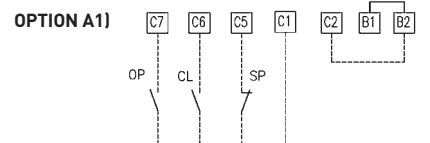

5.6.2 Output contacts

Standard version

- Monitor relay: on the terminal board, the voltage-free, change-over contacts of the monitor relay are available. The monitor relay indicates that the actuator can be remotely controlled or that there is a problem or condition which prevents remote control of the valve. The conditions that cause the relay to switch over are listed in paragraph 9.1.6, Output relays.
- AS1,2,3,4,5,6,7 relays: on the terminal board, the voltage-free contacts of 7 latching relays are available. The status (make or break) and the conditions that cause the switching of the relay can be viewed and configured by using the "VIEW and SET-UP" features. The status of the latching relays is immediately updated as the associated conditions for change occur. Moreover, the status of the above contacts is cyclically updated (every second).
- AS8 relay: a further voltage-free, change-over contact is available on the terminal board. The conditions that cause the switching of the relay can be viewed and configured by using the "VIEW and SET-UP" features.
- Contact rating:
Max. voltage 250 V AC / 30 V DC;
max. current 5 A.
Min. voltage 5 V DC:
min. current 5 mA.

Special version with highly sensitive gold-plated contact relays supplied on request:

- Monitor relay: voltage-free, change-over, gold-cap silver palladium contacts.
- AS1, 2, 3 relays: voltage-free, change-over, latching, gold-cap silver palladium contacts.
- AS4 relay: voltage-free, latching, gold-cap silver palladium contacts, configurable N.O. or N.C. in the "Output relays" menu.
- AS5, 6 relays: voltage-free, change-over, gold-cap silver palladium contacts.
- The conditions that cause the switching over of the monitor relay and auxiliary relays AS1...AS6 are the same of the standard version and are configurable in the "Output relays" menu.
- AS7, 8 relays: not available.
- Contact rating: max voltage 250 V AC; max current 2 A; min switching capability 10 microA, 10 m V DC.

5.6.3 ESD operation

An ESD (Emergency Shut Down) signal can be sent to the actuator to override any existing command and to drive the valve to a predetermined position.

The control is not self-maintained, that is, the ESD action continues until the relevant signal is present. The "VIEW and SET-UP" features can configure the polarity of the ESD signal, the valve position after the ESD action and the priority of the ESD function, as described in paragraph 9.1.3, ESD control.

The ESD command is opto-coupled. The circuits associated to the input can be supplied by the internally generated 24 V DC or by an external 20-125 V DC or 20-120 V AC (50/60 Hz).

- The signal levels are the following:
- Minimum ON signal > 20 V DC or 20 V AC (50/60 Hz).
 - Maximum ON signal < 125 V DC or 120 V AC (50/60 Hz).
 - Maximum OFF signal < 3 V.
 - Current drawn from ESD controls < 15 mA.

WARNING

If customers wish the motor thermostat to be by-passed during ESD operation any certification for actuator enclosure in hazardous area would be invalidated.

5.6.4 Interlock inputs

Two additional inputs are available to inhibit actuator movement in open or close direction. The controls are momentary, and the inhibit action continues until the relevant signal is present. The interlock controls work when the local selector is in either LOCAL or REMOTE positions. The ESD control overrides the interlock controls. The "VIEW and SET-UP" features can configure the polarity of INTERLOCK signal as described in paragraph 9.1.10, Interlock controls.

The interlock inputs are opto-coupled and can be supplied by the internally generated 24 V DC or by an external 20-125 V DC or 20-120 V AC (50/60 Hz).

- The signal levels are the following:
- Minimum ON signal > 20 V DC or 20 V AC (50/60 Hz).
 - Maximum ON signal < 125 V DC or 120 V AC (50/60 Hz).
 - Maximum OFF signal < 3 V.
 - Total current drawn from remote controls < 20 mA.

OPTION D1)

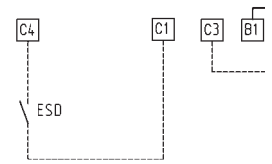

OPTION D2)

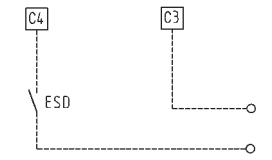

OPTION E1)

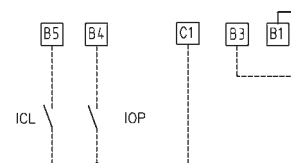

OPTION E2)

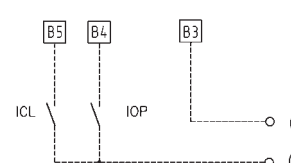

5.7 OPERATING THE ICON 2000 FOR THE FIRST TIME

Before attempting to operate the ICON 2000 for the first time, check that the actuator is correctly mounted on the valve. Place the 3-position selector in OFF and switch the power on. The alphanumeric display shows the following message for about 3 seconds:



Then the new message should be:



or



according to the configuration present in the memory.

If the upper line of the display shows "ALARM OFF", remove the alarm before going ahead (see paragraph 12.11).

If the upper line of the display shows "WARNING OFF", a warning condition is present. You can go ahead since the ICON 2000 is working well, but some datum is not according to the configured parameters (see paragraph 12.11).

If the upper line of the display shows "INT OFF", an Interlock input is active.

If the upper line of the display shows "ESD ON OFF", the ESD input is active.

If the following message appears, the base card is ICON 2000 v4 type, but the actuator is equipped with an ICON 2000 v0 series terminal board. This may happen if the ICON 2000 v4 base card was supplied as a spare card, to replace the base card of the ICON 2000 v0 series (see the previous revision of instruction manuals relevant to the ICON 2000 and its optional modules).



Do not operate the actuator without first checking that the configuration is according to the required application by using the "VIEW and SET-UP" features (see chapter 6/10).

Set torque limits, position limits and close direction by means of the "stroke limits routine" of the "actuator set-up" menu (see chapter 9).

When the stroke limits and the configurations are correct, bring the 3-position selector to LOCAL and drive the actuator to open or closed position (see paragraph 5.3).

5.8 OPTIONAL MODULES

Additional modules can be plugged in the base card of the ICON 2000 to provide the following functions:

5.8.1 Fieldbus interface for remote control via FIELDBUS

This card allows to connect the ICON 2000 to FIELDBUS.

The following bus interface cards are available:

- Profibus DPV0
- Profibus DPV1 with or without redundancy
- Foundation Fieldbus
- LonWorks
- Modbus RTU

A Hardware alarm is generated if the ICON 2000 was set to be equipped with bus card, but the card is damaged or missing. A BUS REPORT is also present in the list of reports if the card is present (see chapter 6). See the specific manuals for instructions and the setting of the above modules.

5.8.2 Ain/Aout card

With the above card the ICON 2000 is provided with a 4-20 analog input and a 4-20 mA analog output. This card should be plugged on the base card, replacing the "TERMINAL BOARD ADAPTOR" card supplied as standard. A Hardware alarm is generated if the ICON 2000 was set to be equipped with an Ain/Aout card, and the card is damaged or missing. An Ain/Aout REPORT is also present in the list of reports if the card is present (see chapter 6).

• 4-20 mA analog output

The 4-20 mA output can be configured to provide a signal proportional to either "position" or "torque". The polarity option allows to reverse the relationship between the position or torque and the 4-20 mA output signal. See "VIEW and SET-UP" features (paragraph 9.1.9, OUT 4-20 mA).

The 4-20 mA output is opto-coupled. It should be powered by a 20-30 V DC voltage (externally or internally generated) and the maximum load, including the cable resistance, should be less than 300 ohm.

Figure A shows the wiring diagram.

The behaviour in case of loss of main voltage is different if the power supply of the 4-20 mA output stage is internally or externally generated:

- Internal power supply (or passive loop):
In case of loss of main voltage the output 4-20 mA drops to 0. The correct output will be restored when the main voltage returns.
- External power supply (or active loop):
If the actuator is provided with an lithium battery (or supplied by the auxiliary 24 V DC) and if the main voltage fails, the output 4-20 mA maintains the last value. If the actuator is moved by handwheel, the output 4-20 mA will be updated.
If the actuator is not provided with an lithium battery (or not supplied by the auxiliary 24 V DC) and if the main voltage fails, the output 4-20 mA maintains the last value.
If the actuator is moved by handwheel, the output 4-20 mA will not be updated.

• 4-20 mA analog input

The 4-20 mA analog input is the position request R% signal and is used by the ICON 2000 to position the valve in inching and modulating actuators. The "POSITIONER" routine processes the input signal, compares the present actuator position % with the position request R% and if the difference is greater than the dead band, the actuator is driven to reach the requested position. 4 mA corresponds to request R% = 0% = valve closed and 20 mA corresponds to request R% = 100% = valve open. The relationship between position and request signals can be reversed by the "Polarity" function. The 4-20 mA input is opto-coupled. The input impedance is less than 500 ohm. The loss of the 4-20 mA input signal is indicated as follows:

- Change-over of the monitor relay
- Alarm LED on
- List of ALARMS (see paragraph 12.11, Diagnostic messages)
- Alarm log

Figure B shows the wiring diagram.

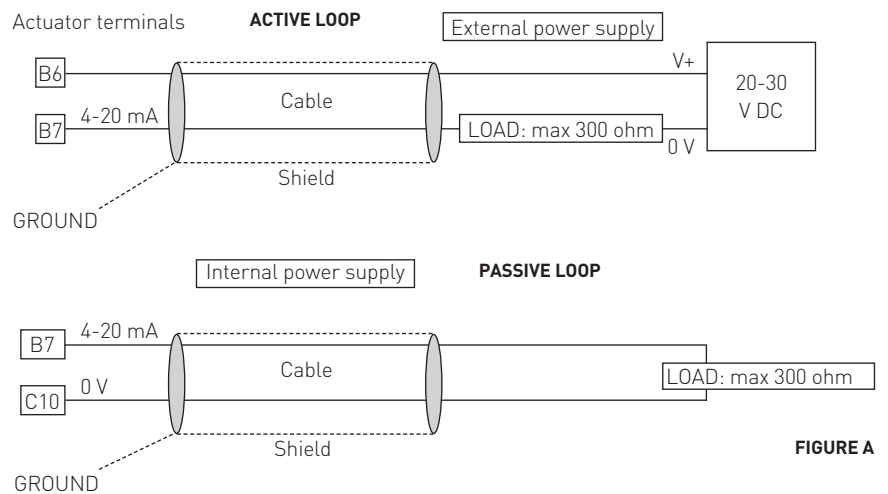

FIGURE A

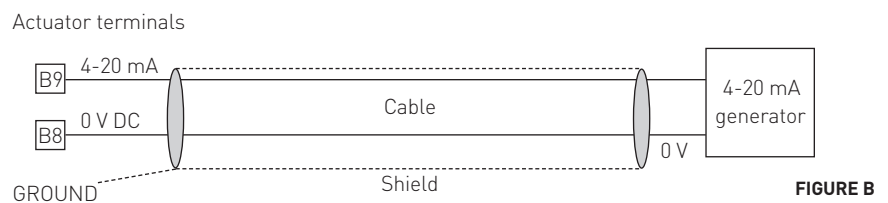
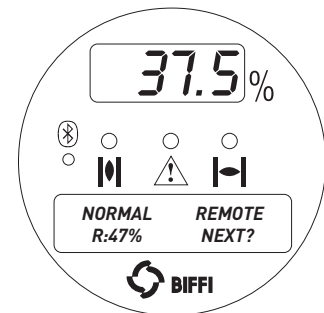

FIGURE B

The "VIEW and SET-UP" features can configure different options which are described in paragraph 9.1.7, Positioner.

If the POSITIONER function is active the alpha-numeric display indicates the value of the position request in % (R%: xxx.x).



5.9 BASE CARD OF THE ICON 2000 V4

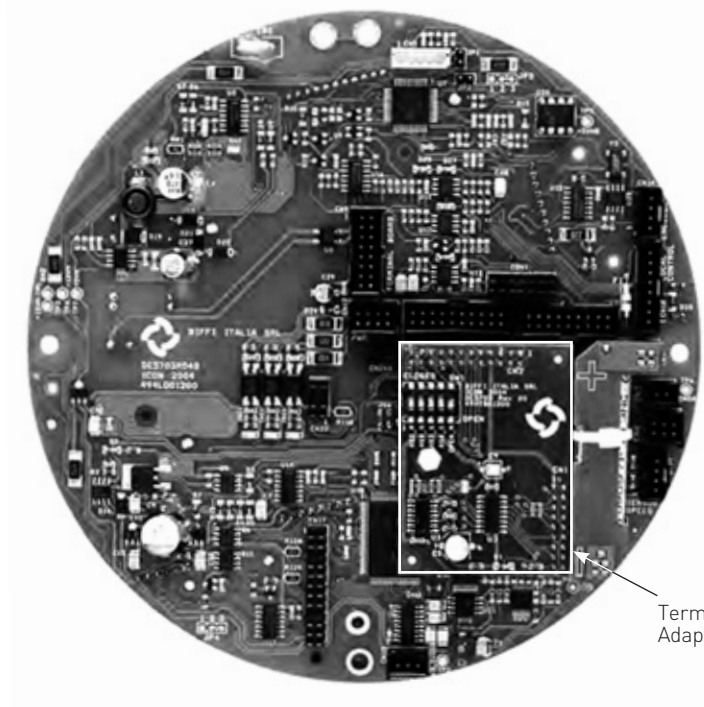

Terminal Board Adaptor card (TBA)

Bottom view of base card

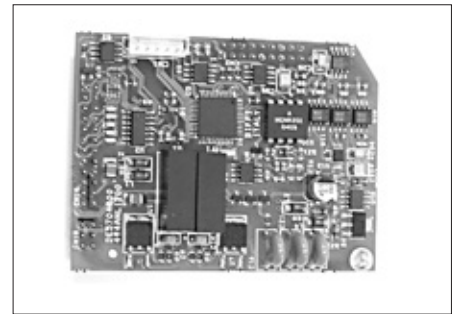

Ain/Aout card

This optional card is used in place of the Terminal Board Adaptor (TBA) card when an analog 4-20 mA input and output signal is requested. This card cannot be used in the actuators with terminal board series ICON 2000 v0 (see paragraph 5.7, Operating the ICON 2000 for the first time).

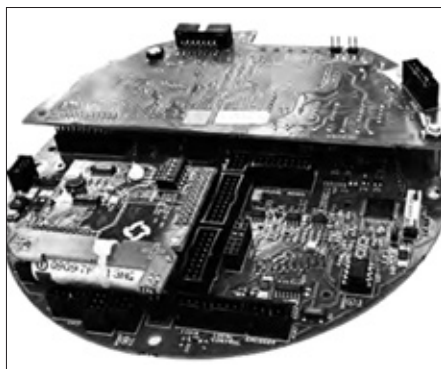

Top view of base card

Base card equipped with fieldbus interface card and Terminal Board Adaptor card.



Fieldbus interface card

The type of card depends on the fieldbus present in the plant.

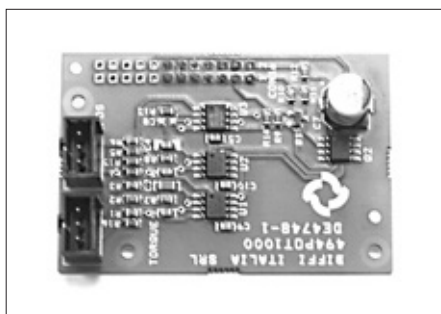
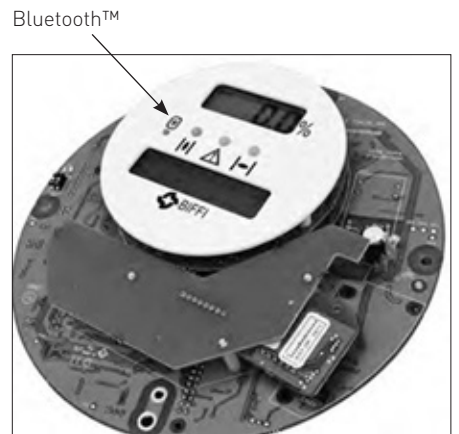

Potentiometer card

With this card properly set trough the VIEW and SET-UP menu, the base card works as F01-2000 v4 base card (see VCIOM-01249 Instruction Manual).

6 LOCAL CONTROLS

6.1 DESCRIPTION OF THE LOCAL OPERATOR INTERFACE

The following functions are available by the ICON 2000 local operator interface:

- actuator control
 - actuator configuration
 - actuator status visualisation
- The figures on the following pages describe the function of each component of the local operator interface.



1
Alphanumeric display: during normal operation the alphanumeric display shows the present status (NORMAL, ESD ON, ALARM, WARNING, INTERLOCK), the 3-position selector status (LOCAL, OFF, REMOTE) and the actuator action (OPEN, OPENING, CLOSED, CLOSING, STOP or R% : xxx.x). If the local selector is in OFF or REMOTE, pressing the YES push-button it is possible to scroll the list of variables, alarms and reports:

| | |
|---------------|-------------------|
| output torque | mot temp |
| motor speed | term temp |
| main voltage | log status |
| current | wireless report |
| temperature | node report * |
| time | FDI report * |
| date | base report |
| alarm | term report |
| warning | Ain/Aout report * |
| Ktemp | |

The data with * are only present if the relevant modules are present.

2
3-position selector to set the following operation modes:

- LOCAL: for local control only
- OFF: no control is active but the actuator is still connected to the mains
- REMOTE: for remote control only

3
The ICON 2000 can be provided with a radiofrequency wireless connection based on a qualified **Bluetooth™** class 1 module. This allows to establish a connection and exchange data with a PDA or PC with built-in Bluetooth™ technology. The following tasks can be wirelessly performed:

- View and change configuration
- Set maintenance function
- Read maintenance data
- Download new firmware to the ICON 2000
- The blue LED indicates that the communication with a host device is established

4
Numeric display to indicate the present valve position as a % of the opening.
Display resolution in function of the actuator stroke turns:

- From 2.8 to 5.5 turns = 1%
- From 5.5 to 13.8 turns = 0.5%
- From 13.8 to 27.7 turns = 0.2%
- From 27.7 to 10,000 turns = 0.1%

5
Three LED's to indicate the actuator status according to the following logic:

- green ON/ red OFF: the actuator is stopped in open position
- green OFF/ red ON: the actuator is stopped in closed position
- green OFF/ red flashing: the actuator is running in closing direction
- green flashing/ red OFF: the actuator is running in opening direction
- green ON/ red ON: the actuator is stopped in intermediate position
- yellow ON: alarm
- yellow flashing: warning

The above color combination is supplied as standard, but it may be changed (red with green, green with red, and yellow with red), during actuator setting operations.

6
Local controls: OPEN/YES, CLOSE/NO, and STOP push-buttons.
The STOP push-button resets any existing command and is active both in local and remote.
If the 3-position selector is in LOCAL, the OPEN / YES, and CLOSE /NO push-buttons work as OPEN and CLOSE commands.
If the 3-position selector is in REMOTE or in OFF, the OPEN / YES and CLOSE / NO push-buttons work as YES and NO to answer the prompt (next? OK? view?, change? exit?) of the alphanumeric display.
In OFF, the OPEN / YES and CLOSE / NO push-buttons allow to scroll down the menu, to view and change the actuator configuration or to scroll the list of variables, status, and alarms.
In REMOTE, the above push-buttons allow scrolling the list of variables, status, alarms and reports but the actuator configuration cannot be viewed or changed.

DESCRIPTION OF VARIABLES AND REPORTS

| | |
|-----------------|--|
| torque | output torque in % of the nominal torque stated in the NAMEPLATE menu |
| motor speed | RPM of electrical motor |
| main voltage | voltage (V) and frequency (Hz) of mains |
| current | current (A) absorbed by the motor |
| temperature | temperature (°C), inside the electronic compartment |
| time | present time |
| date | present date |
| alarm | list of present alarms (see paragraph 12.11, Diagnostic messages) |
| warning | list of present warnings (see paragraph 12.11, Diagnostic messages) |
| Ktemp | temperature factor |
| mot temp | temperature (°C) of the electrical motor |
| term temp | temperature (°C) inside the terminal board compartment |
| log status | data logger status (off, ready, in progress: E: event number - n° of memory cycle or R: sample number - n° of memory cycle) |
| wireless report | Bluetooth™ interface status (ready, not ready) |
| node report | report of bus interface card (only present if the bus card is present) (see the relevant instruction manual) |
| FDI report | report of FDI function (only present if the LonWorks bus card is present) (see the relevant instruction manual) |
| base report | base card report - card code - manufacturing week and year - electrical diagram, etc. |
| term report | terminal board card report - card code - manufacturing week and year - electrical diagram, etc. |
| Ain/Aout report | Ain/Aout card report (only present if the card is present) - card code - manufacturing week and year - electrical diagram, etc. |

The warning condition occurs when a variable reaches a critical value and/or a maintenance action is required, but the actuator control functions are still available. The alarm condition occurs when a variable is out of the acceptable range and the actuator control functions are not available.

The alarm and warning lists only contain the present alarms and warnings. When the fault condition disappears, the corresponding alarm or warning disappears from the list. A reset routine is provided to clear the type of alarm/warning that are memorized (over-torque, jammed valve, etc.).

BIFFI ICON 2000

INSTRUCTION AND OPERATING MANUAL

The following drawing shows the use of the OPEN / YES, CLOSE / NO and STOP push-buttons in function of the local selector position.

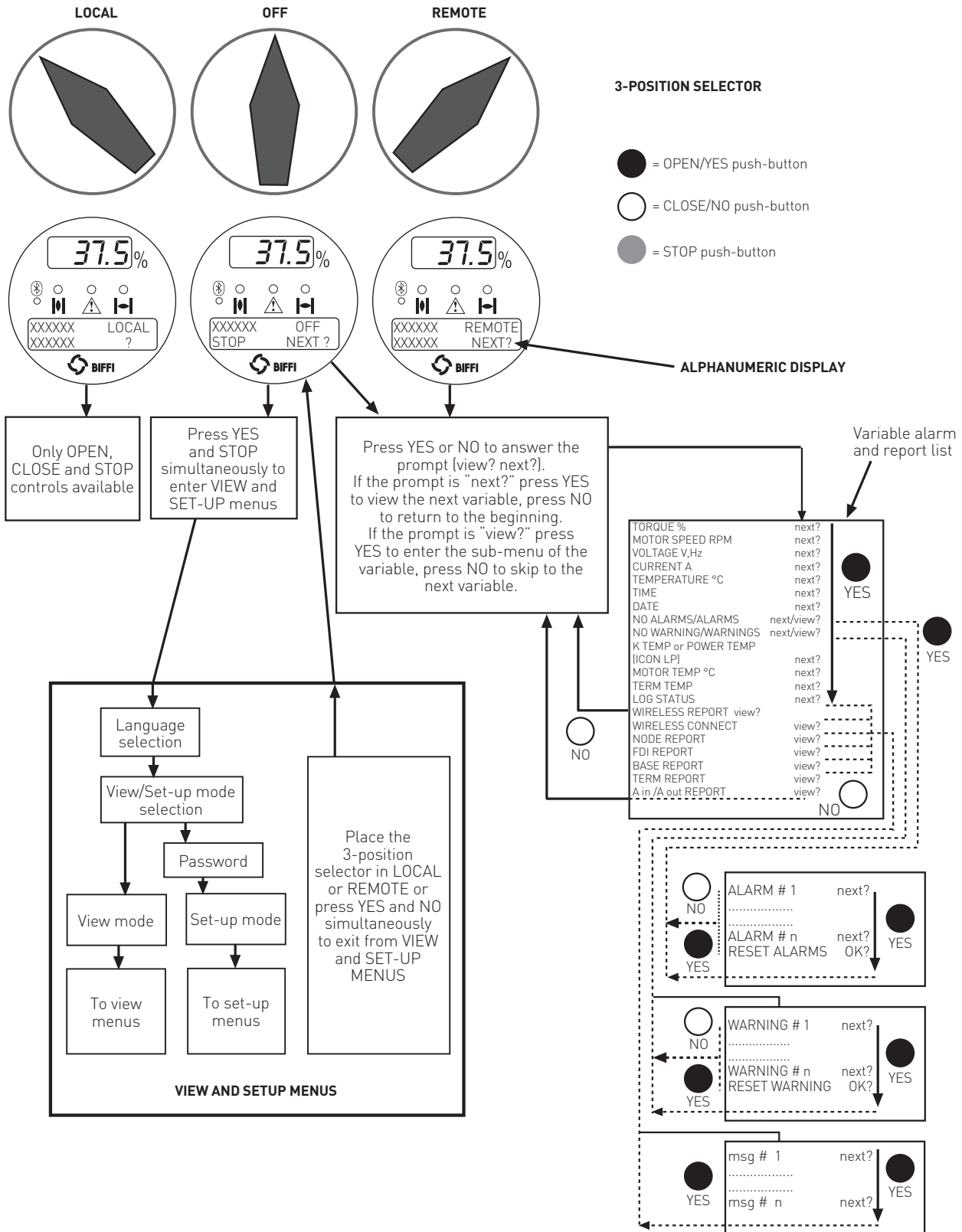

6.2 CONFIGURATION OPTIONS

The ICON 2000 actuator can be totally configured from the local interface by means of a series of menus that can be selected from the alphanumeric display. The operator is guided through the different displays by answering YES or NO to the appropriate prompt (change? OK?, view?, next?, etc.) in the right corner of the lower row of the alphanumeric display.

To access the menus: set the local selector in OFF and then simultaneously press OPEN/YES and STOP. The alphanumeric display will now show the present language. Press YES if the language is correct, press NO to scroll the list of available languages and then YES to select. After choosing the language, the next step is the selection among view and set-up mode. Use "View" mode to see the actuator configuration, and use "Set-up" mode to change the present configuration. Unauthorized access to the set-up mode is prevented by a 4-character alphanumeric password. The actuator is supplied by Biffi with the default password "0 0 0 0".

Once the correct password has been entered, the actuator parameters can be configured. The present password can also be modified by the "set password" routine in the Maintenance menu. After entering the new password, the old one ceases to be valid, so it is important to record the password in a secure location for future retrieval.

The configuration functions (view and set-up mode) are grouped in 4 main menus: Actuator set-up, Nameplate, Valve data, Maintenance.

Actuator set-up

This menu includes the routines that allow the actuator to be configured according to the requested control mode and to the valve it is mounted on.

- stroke limits
- torque set-up
- ESD set-up
- remote controls
- local controls
- output relays
- positioner *
- fail safe *
- out 4-20 mA *
- interlock
- 2-speed timer
- Bus *
- miscellaneous

The routines with * are only available if the relevant modules are present. If bus interface is LonWorks, the "BUS" routine changes to "FDI control".

Nameplate

This menu includes a series of data identifying the actuator characteristics, service, and utilisation mode. The data are entered by the manufacturer and can only be viewed (i.e., this menu is only available in View mode).

- List of routines:
- serial number
 - actuator type
 - torque/thrust
 - actuator speed
 - power supply
 - motor data
 - test date
 - wiring diagram
 - enclosure
 - certificate
 - lubricant
 - revision
 - torque sensor

Valve data

This menu includes a series of data relevant to the valve. The valve manufacturer and end user should enter the data.

- List of routines:
- tag name (max 28 characters)
 - manufacturer (max 28 characters)
 - break OP torque (max 28 characters)
 - serial number (max 28 characters)
 - break CL torque (max 28 characters)
 - max stem thrust (max 28 characters)
 - flange type (max 28 characters)

Maintenance

This menu includes all diagnostic and historic data which can help the operator in case of failure or during maintenance operations. The Maintenance menu also includes the "Set password" routine.

List of routines:

- *Set-up mode*
 - set new password
 - clear alarm log
 - set torque profile reference
 - set torque curve reference
 - clear recent data log
 - set maintenance date
 - set data logger
- *View mode*
 - alarm log
 - torque profile
 - torque curve
 - operation log
 - maintenance date
 - data logger

The parameters appear on the alphanumeric display in the same order both in view and set-up mode. At the end of each routine the program will automatically return to the beginning of the routine, and the operator can choose to either re-enter (by pressing YES) or to move on to a next routine (by pressing NO).

6.3 ENTERING THE VIEW MODE

The existing actuator configuration should be checked before commissioning. The parameters are configured in factory according to a standard setting, or to customer requirements. In view mode, no password is requested, but no change of parameters can be made.

- Ensure the electrical main power is applied.
- Move the 3-position selector to OFF and then simultaneously press OPEN/YES and STOP.
- The display shows the present language. Press YES to confirm or NO to scroll the list of available languages. Press YES to select a new language. Press YES to confirm.
- Press NO to scroll the list of available menus (actuator set-up, nameplate, valve data, maintenance) and then press YES to select the desired menu.
- Press NO to scroll the list of available routines and press YES to select the routine where the parameter to be changed is located.
- Press NO to scroll the list of parameters and press YES to view the value.

6.4 ENTERING THE SET-UP MODE

To change the existing settings or to set the stroke limits it is necessary to enter the correct password.

- Ensure the electrical main power (or the external auxiliary supply) is applied.
- Move the 3-position selector to OFF and then simultaneously press OPEN/YES and STOP.
- The display shows the present language. Press YES to confirm or NO to scroll the list of available languages. Press YES to select. Press YES to confirm the chosen language.
- Press NO when the message is "VIEW MODE OK?". Press YES to answer prompt "ENTER PASSWORD OK?".
- Enter password. Enter one digit at a time. Press YES if digit is correct, press NO to scroll the list of available characters and then press YES when the character is correct. Enter 4 digits. After entering the last digit, the microprocessor checks the password. If it is correct the messages "PASSWORD CORRECT" and then "SET-UP MODE OK?" appear. Press YES.
- Press NO to scroll the list of available menus (actuator set-up, valve data, maintenance) and press YES to select the desired menu.
- Press NO to scroll the list of available routines and press YES to select the routine where the parameter to be changed is located.
- Press YES and NO to answer the prompt on the display and change the parameter.
- If the password is wrong the message "PASSWORD WRONG" appears and set-up mode will not be available.

All settings are automatically saved to a non-volatile memory and retained also if the electrical power is removed from the actuator. All ICON 2000 actuators are configured before shipping with a standard default setting unless alternatives were requested on order. In case of difficulty during commissioning, the default setting can be re-instated by the appropriate function in the routine "miscellaneous" of the actuator set-up menu. The actuator returns to its original configuration and commissioning can be resumed.

6.5 EXIT FROM VIEW AND SET-UP MODE

The following conditions cause the exit from view and set-up mode:

- Move the 3-position selector to LOCAL or REMOTE.
- Answer YES when the display asks "EXIT OK?".
- Press YES and NO simultaneously.
- Automatic exit after 90 minutes without any parameter change or view.
- Remove the electrical power from the unit.

7 SET-UP MENU

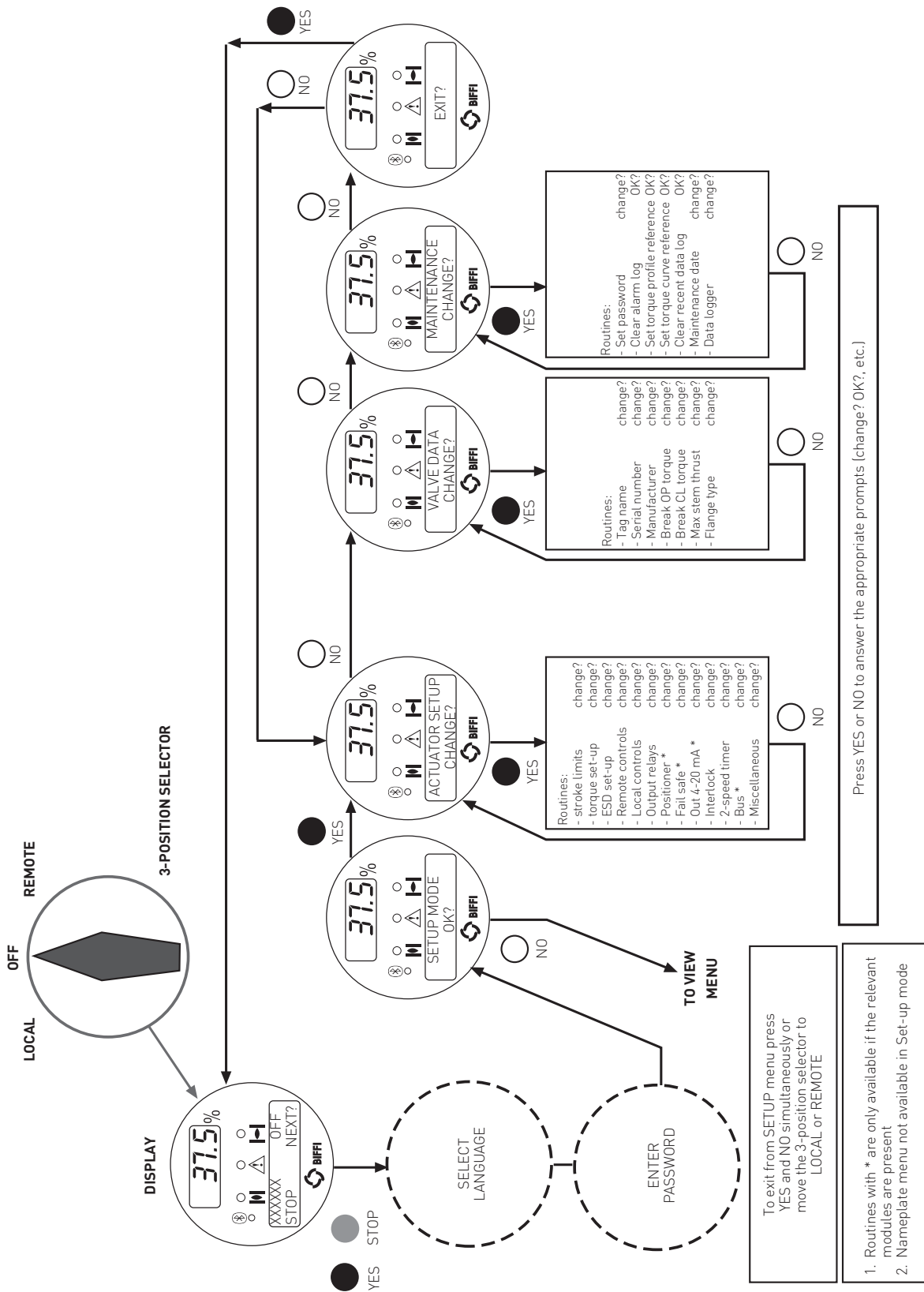

The figure below shows the procedure to move in the set-up routines.

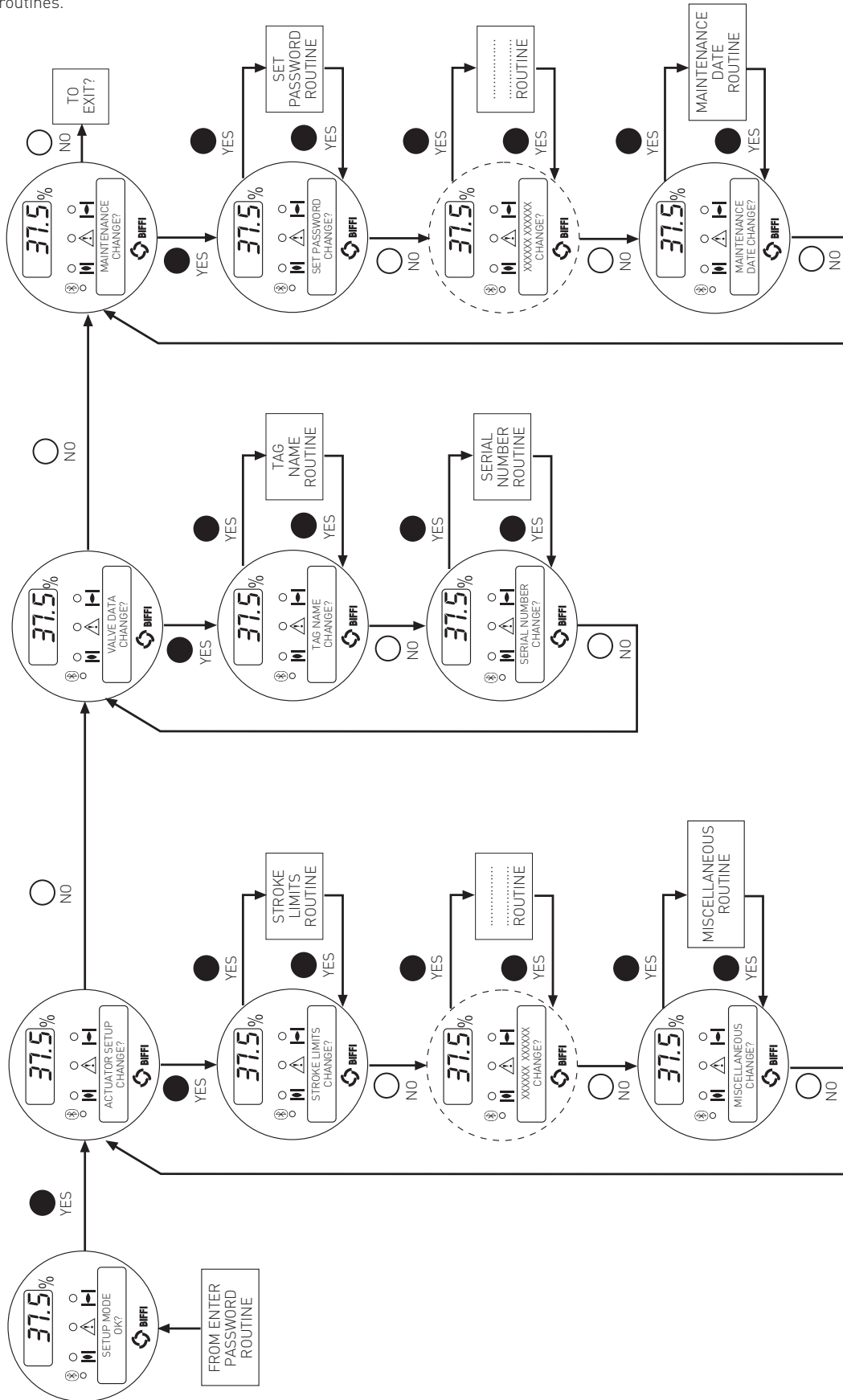

8 VIEW MENU

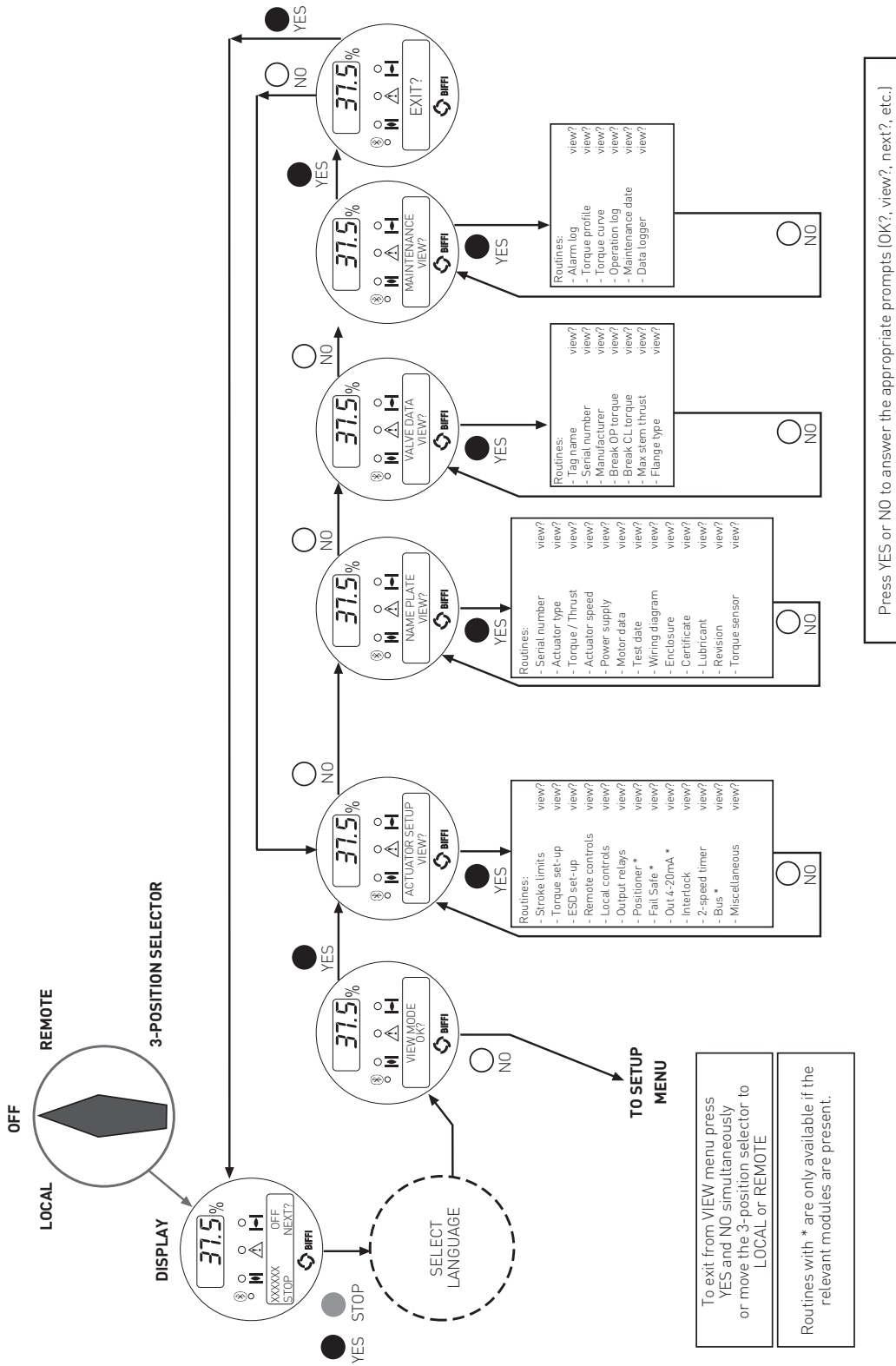

The figure below shows the procedure to move in the view routines.

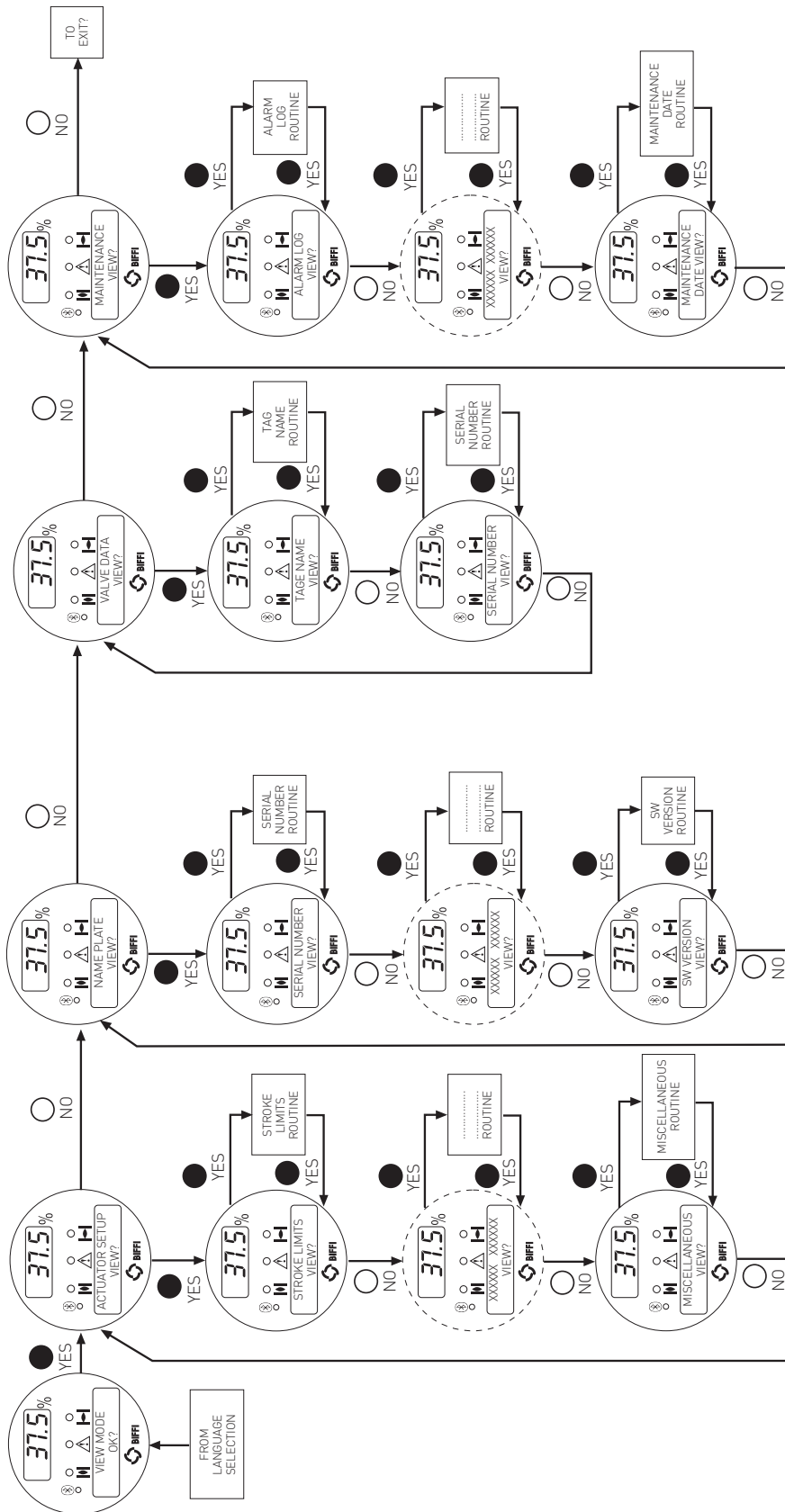

9 SET-UP ROUTINES

9.1 ACTUATOR SET-UP

9.1.1 Set stroke limits

This routine allows the actuator to be configured according to the type of valve it is mounted on.

The following parameters will be set:

- Opening and closing torque limits: from 40% to 100% of the nominal torque. The nominal torque corresponding to 100% is set in-house and is stated in the name plate menu for reference.
- Close direction: clockwise (CW) or counter-clockwise (CCW). Most valves require clockwise rotation of the stem when viewed from the handwheel. Engage the manual override and check if the valve closes with clockwise or counter-clockwise rotation of the handwheel.
- Close and open limits type: by position or by torque. Use the table below to choose.

Set-up procedure

- Engage the manual override and move the valve to the mid-travel position.
- Move the local selector to OFF and then simultaneously press OPEN and STOP. Select the language and then enter the password according to the instructions (see "Entering the set-up mode"). When the message displayed is "SET-UP MODE OK?" press YES. Press YES to select the actuator set-up menu, and then press YES again to start with the stroke limits routine.
- Press YES if the closing torque limit is correct or NO to scroll the list of available values. When the value is correct, press YES.
- Press YES if the opening torque limit is correct or NO to scroll the list of available values. When the value is correct press YES.
- Press YES if the rotation to close is correct (CW or CCW), or NO to change. When the value is correct press YES.
- Press YES to set the close limit, or NO and then YES to set the open limit.

Close limit type

Press YES if the close limit type is correct (torque or position), press NO to change it. Press YES when the type is correct.

Close limit by position

- Move the local selector to LOCAL. The local controls can be used.
- Move the valve to closed position (by CLOSE control or by handwheel).
- Move the local selector to OFF.
- Press YES to confirm.
- Press YES to continue with the open limit setting, or press NO and again NO to repeat the close limit setting procedure. Press NO and then YES to exit from the stroke limits routine.

Close limit by torque

- Move the local selector to LOCAL. The local controls can be used.
- Press the CLOSE control. The actuator moves in closing direction and when the configured torque value is reached the motor is stopped and the new position limit is memorized.
- Move the local selector to OFF.
- Press YES to confirm.
- Press YES to continue with the close limit setting, or press NO and again NO to repeat the close limit setting procedure. Press NO and then YES to exit from the stroke limits routine.

Open limit type

- Press YES if the open limit type is correct (torque or position), press NO to change it. Press YES to confirm.

Open limit by position

- Move the local selector to LOCAL. The local controls become active.
- Move the valve to open position (by OPEN control or by handwheel).
- Move the local selector to OFF.
- Press YES to confirm.
- Press YES to exit, or press NO and then YES to repeat the close limit setting procedure.

Open limit by torque

- Move the local selector to LOCAL. The local controls become active.
- Press the OPEN control. The actuator moves in opening direction and when the configured torque value is reached the motor is stopped and the new position limit is memorized.
- Move the local selector to OFF.
- Press YES to confirm.
- Press YES to exit or press NO and then YES to repeat the close limit setting procedure. If parameter "direction to close" is changed, both limits (open and close) must be set.

Before leaving the stroke limits routine the microprocessor calculates the new value of the position resolution. If the stroke turns are less than 2.7, the message "error re-try" appears and the stroke limits procedure must be repeated.

9.1.2 Torque set-up

The output torque limits to close or to open may be configured between 40% and 100% of the nominal torque stated on the actuator nameplate.

Set-up procedure

- Move the local selector to OFF and then simultaneously press OPEN and STOP. Select the language and then enter the password according to the instructions (see "Entering the set-up mode"). When the message displayed is "SET-UP MODE OK?" press YES. Press YES to select the actuator set-up menu, press NO and then press YES to select the torque set-up routine.
- Press YES if the opening torque limit is correct, press NO to scroll the list of available values. Press YES when the value is correct.
- Press YES if the closing torque limit is correct, press NO to scroll the list of available values. Press YES when the value is correct.

| Valve type | Close limit | Open limit |
|--|--------------------|------------|
| Gate (solid, flexible and split wedge), globe, metal seated butterfly valves | Torque | Position |
| Ball, gate (parallel slide), plug valves, rubber seated butterfly valves | Position | Position |
| Linear valves with back-seating on stem | Torque or position | Torque |

9.1.3 ESD control

An ESD signal can be connected to the actuator to override any existing command and drive the valve to a predetermined position. The ESD control is not self-maintained: the ESD action is only performed if the relevant input is active. The ESD control is active when the 3-position selector is in REMOTE and no alarm is present.

WARNING

The user may select ESD to override the situations indicated by (). If these situations occur and if "ESD > ..." is configured, the actuator may be damaged. Therefore, selecting "ESD > ..." will invalidate the warranty.*

Function "ESD priority" allows the ESD command to override the following additional situations: (*) motor thermostat alarm, (*) torque limit tripped, (*) local stop pressed, 3-position selector in local, 2-speed timer, (*) 3-position selector in OFF.

Configuration procedure

- Move the local selector to OFF and then simultaneously press OPEN and STOP. Select the language and then enter the password according to the instructions (see "Entering the set-up mode"). When the message displayed is "SET-UP MODE OK?" press YES. Press YES to select actuator set-up menu, press NO to scroll the list of available routines and then press YES to select ESD set-up.
- Press YES if the ESD action is correct, or press NO to scroll the list of available options (off, open, close, stay-put, go to position xx %). Press YES to select the desired option.
- Press either YES or NO to select the signal type (present, absent).
- Press YES to change ESD priority with reference to the following signals or status:
 - (*) Motor thermostat alarm. Choosing ESD > THERMOSTAT, the ESD action will be carried out also in case of motor over-heating. Vice-versa, if ESD < THERMOSTAT was chosen, the ESD action will not be done in case of motor over-heating.
 - (*) Torque limit tripped. Choosing ESD > TORQUE LIMIT, the ESD action will be carried out also in case of torque alarm. Vice-versa, if ESD < TORQUE LIMIT was chosen, the ESD action will not be done in case of torque alarm.
 - (*) Local stop pressed. Choosing ESD > LOCAL STOP, the ESD action will override the local STOP signal. Vice-versa, if ESD < LOCAL STOP was chosen, the ESD action will not be performed if the local STOP push-button is pressed.

- Local selector in LOCAL. Choosing ESD > LOCAL CONTROLS, the ESD action will be carried out also when the local selector is in LOCAL. Vice-versa, if ESD < LOCAL CONTROLS was chosen, the ESD action will not be performed if the 3-position selector is in LOCAL.
- 2-speed timer. Choosing ESD > 2-speed timer, the 2-speed timer function will be inhibited during ESD action. Vice-versa, if ESD < 2-speed timer was chosen, the 2-speed timer function will be active during ESD action.
- (*) Local selector in OFF. By choosing ESD > OFF, the ESD action will be carried out also when the local selector is in OFF. Vice-versa, if ESD < OFF was chosen, the ESD action will not be performed if the 3-position selector is in OFF.

The factory configuration is the following:
action: CLOSE, signal type: PRESENT,
priorities: ESD > LOCAL CONTROLS,
ESD > 2-SPEED TIMER, ESD < all other cases.

9.1.4 Remote controls

The actuator may be remotely controlled by 4, or 3, or 2 wires depending on the connection made on the terminal board of the actuator.

The following options are available:

- 4 wires latched: requires 2 momentary signals (since the control is self-maintained) to open or close and one signal to stop in mid-travel. The action of the stop signal can be reversed (stop when signal is On [MAKE] or stop when signal is Off [BREAK]).
- 3 wires latched instant reverse: requires 2 momentary signals (since the control is self-maintained) to open or close. Reverse momentary signal reverses the direction.
- 3 wires momentary: requires 2 push-to-run type signals (since the control is not self-maintained) to open or close.
- 2 wires open if signal On: requires signal On to open and no signal to close.
- 2 wires open if signal Off: requires signal Off to open and signal On to close.

By selecting the option Off, the remote controls are disabled.

Configuration should be done during actuator set-up.

Configuration procedure

- Move the local selector to OFF and then simultaneously press OPEN and STOP. Select the language and then enter the password according to the instructions (see "Entering the set-up mode"). When the message displayed is "SET-UP MODE OK?" press YES. Press YES to select actuator set-up menu, press NO to scroll the list of available routines and then press YES to select Remote controls.

- Press YES if the control mode is correct or NO to scroll the list of available options: 4 wires, 3 wires, 2 wires, off. Press YES to select the desired option. If 4 wires was chosen use YES and NO to select the STOP signal: set MAKE to stop when signal is on and set BREAK to stop when signal is off. If "3 wires" was chosen, use YES or NO to answer the prompt on the display and choose among "push-to-run" or "latched instant reverse" control modes. If "2 wires" was chosen, use YES and NO to choose among "open if signal ON" or "open if signal OFF" control modes.

9.1.5 Local controls

This routine allows:

- To configure the control mode by means of the local controls when the 3-position selector is in LOCAL. The available options are "push-to-run", "latched", "latched with instant reverse".
- To set the LED's color. The following options are available: open LED: green or red; close LED: green or red; alarm LED: yellow or red.

Configuration procedure

- Move the local selector to OFF and then simultaneously press OPEN and STOP. Select the language and then enter the password according to the instructions (see "Entering the set-up mode"). When the message displayed is "SET-UP MODE OK?" press YES. Press YES to select the actuator set-up menu, press NO to scroll the list of available routines and then press YES to select Local controls.
- Press YES to change control mode, or press NO to proceed to LED's color setting.

Control mode

- Press YES if the display shows the correct control mode or press NO to scroll the list of available options (push-to-run, latched). Press YES to confirm.
Option "push-to-run rel. AS5-6" is used when a remote enabling of local commands is required. With the local selector in LOCAL, pressing the OPEN or CLOSE local push-buttons causes relays AS5 or AS6 to switch, but no command is sent to motor. The control PLC should read the status of the above-mentioned relays and send an open or close command on the remote inputs (see paragraph 5.6, push-to-run mode; see relevant electrical diagram when the option is used).

LED's color

- Press YES if the color of the open LED is correct. Press NO to change it, then YES to confirm.
- Press YES if the color of the close LED is correct. Press NO to change it, then YES to confirm.
- Press YES if the color of the alarm LED is correct. Press NO to change it, then YES to confirm.

9.1.6 Output relays

Monitor relay

The voltage-free, change-over, contacts of the monitor relay indicate that the actuator is either available for remote control or that a problem or a condition preventing remote control of the valve exists.

The monitor relay is normally energized and will be de-energized on:

- main voltage failure
- lost phase
- internal temperature alarm
- K1 contactor failure
- K2 contactor failure
- position sensor failure
- speed sensor failure
- configuration error
- HW error
- mid-travel alarm

The following situation can be configured individually to switch-over the monitor relay:

- motor over-temperature
- over-torque
- jammed valve
- LOCAL/OFF selected
- manual operation
- ESD signal on (ESD-EFS)
- low lithium battery (if present)
- LOCAL/STOP pressed

Auxiliary output relays

For status indication or diagnostic purposes, 8 voltage-free contacts of 8 relays are available to be configured individually to switch for the following conditions:

Status

- open limit
- closed limit
- position \geq xx %
- position \leq xx %
- closing
- opening
- motor running
- blinker
- mid-travel position
- local selected
- remote selected
- local stop active
- ESD signal on
- manual operation

Alarm

- motor over-temperature
- over-torque
- over-torque in OP
- over-torque in CL
- valve jammed
- warnings
- valve jammed in OP
- valve jammed in CL
- low lithium battery (if present)
- mid travel alarm in CL/OP
- mains-only AS8

The contacts may be configured to make or break on condition. The options "EFS in manual", "EFS mid-travel" and "PST failed" also appear in the menu, but are not available for ICON 2000 v4.

Configuration procedure

- Move the local selector to OFF and then simultaneously press OPEN and STOP. Select the language and enter the password according to the instructions (see "Entering the set-up mode"). When the message displayed is "SET-UP MODE OK?" press YES. Press YES to select actuator set-up menu, press NO to scroll the list of available routines and then press YES to select Output relays.
- Press YES to select DEFAULT #1, or press NO to change.
- Press YES to select DEFAULT #2, or press NO to configure the output relays.

Default #1

Monitor relay

- main voltage failure
- lost phase
- local/off selected
- local stop pressed
- manual operation
- internal temperature alarm
- K1 contactor failure
- K2 contactor failure
- position sensor failure
- speed sensor failure
- configuration error
- HW error
- motor over-temperature
- over-torque
- jammed valve
- low lithium battery (if present)
- mid-travel alarm

Auxiliary relays

- AS1: open limit; make
- AS2: close limit; make
- AS3: selec. REMOTE pos. make
- AS4: overtorque/break
- AS5: motor running; make
- AS6: position <10% /make
- AS7: ESD active; make
- AS8: motor overtemperature

Default #2

Monitor relay

- main voltage failure
- lost phase
- local/off selected
- local stop pressed
- manual operation
- internal temperature alarm
- K1 contactor failure
- K2 contactor failure
- position sensor failure
- speed sensor failure
- configuration error
- HW error
- motor over-temperature
- over-torque
- jammed valve
- low lithium battery (if present)
- mid-travel alarm

Auxiliary relays

- AS1: open limit; break
- AS2: close limit; break
- AS3: selec. REMOTE pos. make
- AS4: overtorque/break
- AS5: motor running; make
- AS6: remote selected; make
- AS7: warning; make
- AS8: mains

Configure output relays

- Press YES to change the monitor relay or NO to change auxiliary relays AS1, 2, 3, 4, 5, 6, 7, 8.

Monitor relay

- Press YES or NO to enable or disable the following situations from the conditions which de-energize the monitor relay: motor over-temperature, over-torque, jammed valve, manual override, ESD signal on, low lithium battery (if present), local STOP pressed, LOCAL/OFF selected.

Auxiliary relays AS1, 2, 3, 4, 5, 6, 7 and 8

- Press NO to answer prompt "MONITOR RELAY change?".
- Press YES to change AS1, press NO to select the other relays.
- Press YES if the condition associated to AS1 relay is correct, press NO to scrolls the list of conditions and press YES to set.
- Press YES or NO to either confirm or change the type of contact when the condition occurs (break, make). Since relay AS8 is change-over, this option is not available.
- Press NO to pass to AS2 and then repeat the procedure for the other relays.
- Press NO to exit.

9.1.7 Positioner

The positioning function is only available in inching or modulating ICON 2000 actuators and allows to position the valve according to a "position request R%" command signal. The positioning function compares the present actuator position % with the position request R%, and if the difference is greater than the dead band the actuator is driven to reach the new requested position.

The "position request R%" signal may either be received from the bus or the 4-20 mA analog input. If the ICON 2000 is set to receive the position request R% from the bus, a fieldbus interface card must be present, or a Hardware alarm will be generated. If the ICON 2000 is set to receive the position request R% from the 4-20 mA generator, the Ain/Aout card must be present, or a Hardware alarm will be generated.

The following options can be configured via local operator interface:

- Dead band: configurable from "position resolution%" to 25.5% of the maximum position error. The configured value should be great enough to avoid the hunting effect.
- Polarity of the 4-20 mA position request signal: it allows to reverse the relationship between the 4-20 mA input signal and the "position request R%", according to the following diagrams. The option is not available when the ICON 2000 is set to receive the "position request R%" from the bus.
- Motion inhibit time: it allows to adjust the length of the delay time between two cycles of the motor. It can be configured from 1 to 255 secs and allows to set the maximum number of start/hour of the electrical motor.
- % MIN and % MAX, 4-20 mA input signal range: it allows to change the relationship between the input signal and the position request R%. This function is useful when a single 4-20 mA signal is used to control the position of 2 valves (e.g.: split range applications). The option is not available when the ICON 2000 is set to receive the "position request R%" from the bus.

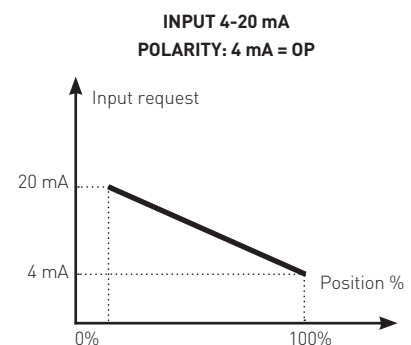
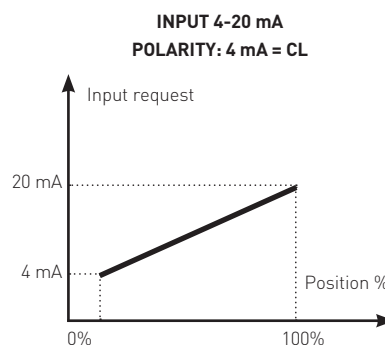

The curves below may better clarify the above option:

Example A

With input signal = 4 mA, the position request is 0% and the actuator is driven to close. With input signal = 20 mA, the position request is 100% and the actuator is driven to open. With input signal = 12 mA the position request is 50% and the actuator is driven to reach position 50%.

Example B

With input signal < 8 mA, the position request is 0% and the actuator is driven to close. With input signal = 16 mA, the position request is 100% and the actuator is driven to open. With input signal = 12 mA the position request is 50% and the actuator is driven to reach position 50%.

Example C

With input signal = 4 mA , the position request is 100% and the actuator is driven to open. With input signal = 20 mA, the position request is 0% and the actuator is driven to close. With input signal = 12 mA the position request is 50% and the actuator is driven to reach position 50%.

Example D

With input signal < 8 mA, the position request is 100% and the actuator is driven to open. With input signal = 16 mA , the position request is 0% and the actuator is driven to close. With input signal = 12 mA the position request is 50% and the actuator is driven to reach position 50%.

Configuration procedure

- Move the local selector to OFF and then simultaneously press OPEN and STOP. Select the language and then enter the password according to the instructions (see Entering the set-up mode). When the message displayed is "SET-UP MODE OK?" press YES. Press YES to select the actuator set-up menu, press NO to scroll the list of available routines and then press YES to select POSITIONER.
- Press YES if the configured value of the Dead Band is correct (from "position resolution %" to 25.5%), or press NO to change it, then press YES.
- Press YES if the configured value of the Polarity is correct (4 mA=CL or 4 mA=OP), or press NO to change it, then press YES.
- Press YES if the configured value of the Motion Inhibit Time is correct (from 1 to 255 sec), or press NO to change it, then press YES.

- Press YES if the configured value of the % MIN is correct (from 0 to 75%), or press NO to change it, then press YES. The standard value is 0.
- Press YES if the configured value of the % MAX is correct (from 25 to 100%), or press NO to change it, then press YES. The difference between % MAX and % MIN should be greater than 25%. The standard value is 100.

9.1.8 Fail Safe

This function configures the actuator action in case of loss of the 4-20 mA input or bus signals. This action only takes place if the local selector is in REMOTE and if the positioning function or the bus interface are active. When the 4-20 mA or bus signal is restored, the ICON 2000 resumes its normal functioning. The Interlock and ESD controls override the Fail Safe action according to the following diagram:

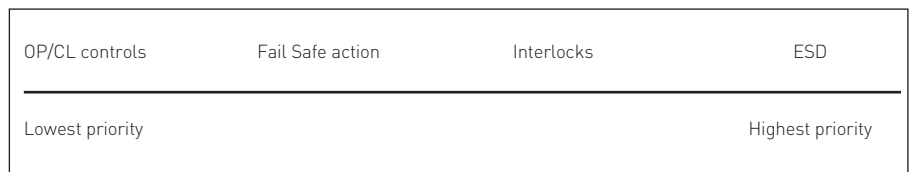

- The following options can be configured:
- Action: open, close, stay-put, go to position %, no action (OFF).
 - Delay: time before than the Fail Safe action takes place.

EXAMPLE A

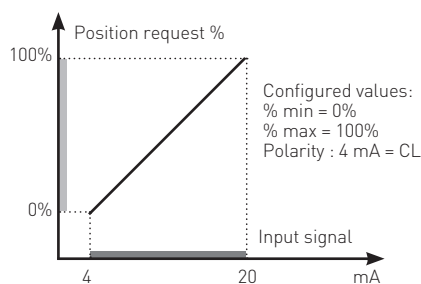

EXAMPLE B

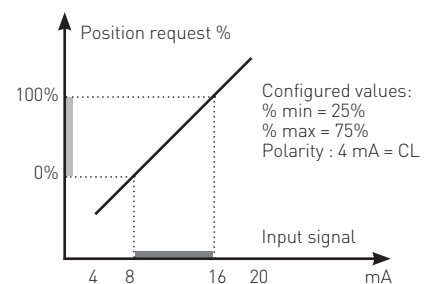

EXAMPLE C

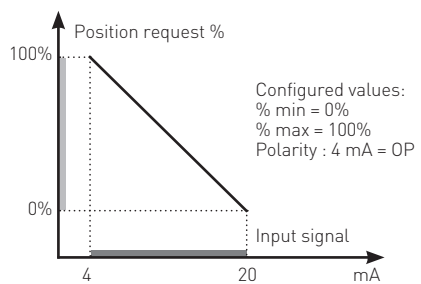

EXAMPLE D

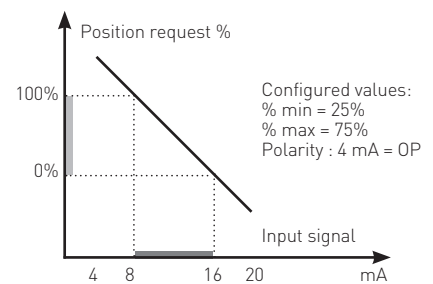

Configuration procedure

- Move the local selector to OFF and then simultaneously press OPEN and STOP. Select the language and then enter the password according to the instructions (see entering the set-up mode). When the message displayed is "SET-UP MODE OK?" press YES. Press YES to select the actuator set-up menu, press NO to scroll the list of available routines and then press YES to select FAIL SAFE.
- Press YES if the configured ACTION is correct (open, close, stay-put, go to position xxx%, off), or press NO to change it, then press YES.
- Press YES if the configured value of the DELAY is correct (from 0 to 255 sec), or press NO to change it, then press YES.

9.1.9 OUT 4-20 mA

This routine is only available if the Ain/Aout card is present. With this card the ICON 2000 is provided with a 4-20 mA analog input and a 4-20 mA analog output.
The 4-20 mA output can be configured to provide a current proportional to either "position" or "torque". The polarity option allows to reverse the relationship between the present position or torque and the 4-20 mA output signal, according to the following diagrams:

**OUTPUT: POSITION
POLARITY: 4 mA = CL**

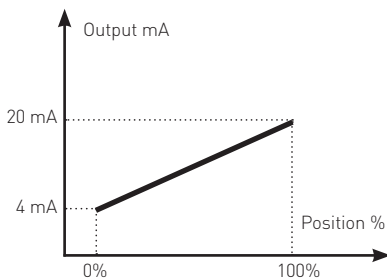

**OUTPUT: POSITION
POLARITY: 4 mA = OP**

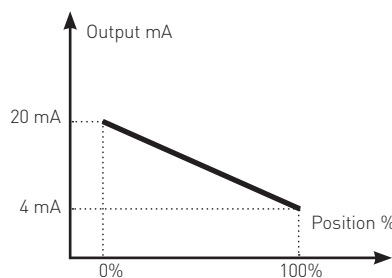

**OUTPUT: TORQUE
POLARITY: 4 mA = CL**

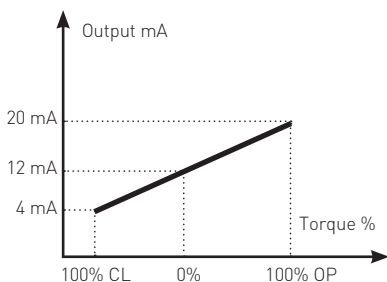

**OUTPUT: TORQUE
POLARITY: 4 mA = OP**

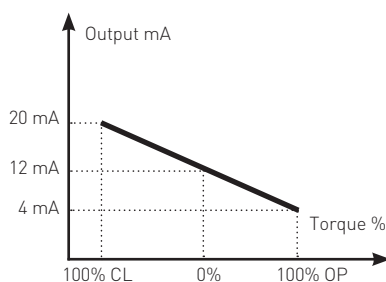

Configuration procedure

- Move the local selector to OFF and then simultaneously press OPEN and STOP. Select the language and then enter the password according to the instructions (see "entering the set-up mode"). When the message of the display is "SET-UP MODE OK?" press YES. Press YES to select the actuator set-up menu, press NO to scroll the list of available routines and then press YES to select Out 4-20 mA.
- Press YES if the output is correct (POSITION or TORQUE), or press NO to change it, then press YES.
- Press YES if the polarity is correct, or press NO to change it, then press YES.

9.1.10 Interlock

The interlock inputs can be used to inhibit the actuator movement in open or close direction. The controls are momentary, the inhibit action continues until the relevant signal is present. The interlock controls work when the local selector is in LOCAL or in REMOTE. The ESD control overrides the interlock controls. The following options can be configured:

- *Interlock OP:*
active when signal is PRESENT, active when signal is ABSENT, no action (OFF).
- *Interlock CL:*
active when signal is PRESENT, active when signal is ABSENT, no action (OFF).

Configuration procedure

- Move the local selector to OFF and then simultaneously press OPEN and STOP. Select the language and then enter the password according to the instructions (see entering the set-up mode). When the message displayed is "SET-UP MODE OK?" press YES. Press YES to select the actuator set-up menu, press NO to scroll the list of available routines and then press YES to select INTERLOCK.
- Press YES if the configured value of the Open Interlock is correct (PRESENT, ABSENT, OFF), or press NO to change it, then press YES.
- Press YES if the configured value of the Close Interlock is correct (PRESENT, ABSENT, OFF), or press NO to change it, then press YES.

9.1.11 2-Speed timer

The "2-speed timer" routine is used to extend the actuator travelling time in opening and/or closing direction, by driving the motor by pulses which duration (ON and OFF time) is configurable. Pulsing control can be applied to full travel or only a part of it.

Start position and stop position may be adjusted from 0% - 100% separately in opening and closing direction.

ON time and OFF time may be adjusted from 1 sec - 200 sec separately in opening and closing direction.

Configuration procedure

- Move the local selector to OFF and then simultaneously press OPEN and STOP. Select the language and then enter the password according to the instructions (see "Entering the set-up mode"). When the message displayed is "SET-UP MODE OK?" press YES. Press YES to select actuator set-up menu, press NO to scroll the list of available routines and then press YES to select 2-speed timer.
- Press YES to change close direction parameters, press NO and then YES to change only open direction parameters.

Closing direction

- Press YES if the status is OK, or NO to change. Press YES to confirm (status = On, enables 2-speed timer operation in closing direction status = Off, disables timer operation in closing direction).
- Press YES if the position value where pulsing control starts is correct, press NO to scroll the list of available values. Press YES when the value is correct.
- Press YES if the position value where pulsing control stops is correct, press NO to scroll the list of available values. Press YES when the value is correct.
- Press YES if the value of the ON time of pulsing control is correct, press NO to scroll the list of available values. Press YES when the value is correct.
- Press YES if the value of the OFF time of pulsing control is correct, press NO to scroll the list of available values. Press YES when the value is correct.

Opening direction

- Press YES if the status is OK, or NO to change. Press YES to confirm (status = On enables 2-speed timer operation in opening direction status = Off, disables timer operation in opening direction).
- Press YES if the position value where pulsing control starts is correct, press NO to scroll the list of available values. Press YES when the value is correct.

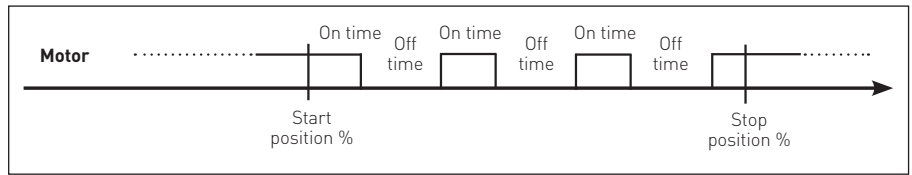

- Press YES if the position value where pulsing control stops is correct, press NO to scroll the list of available values. Press YES when the value is correct.
- Press YES if the value of the ON time of pulsing control is correct, press NO to scroll the list of available values. Press YES when the value is correct.
- Press YES if the value of the OFF time of pulsing control is correct, press NO to scroll the list of available values. Press YES when the value is correct.
- Enter hours, minutes and seconds. Press NO to scroll the list of available values, press YES to select.
- Press YES when the time is correct.
- Press YES if the date is correct, press NO to change.
- Enter day, month, and year. Press NO to scroll the list of available values, press YES to select.
- Press YES if the date is correct.

9.1.12 BUS (or FDI control)

This routine is only available if a fieldbus interface card is present. The routine allows setting the most important parameters (node address, termination, etc.) necessary to connect the actuator to a fieldbus. If the ICON 2000 was set to work with fieldbus, but the fieldbus card is not present, a Hardware alarm will be generated. Different interfaces are available to connect the ICON 2000 to different types of fieldbus. If the bus interface is LonWorks, the routine "BUS" changes in "FDI control". See the specific manuals for instruction and setting of the above modules.

9.1.13 Miscellaneous

It includes different types of routines as "time and date", "factory settings", "lithium battery", "torque profile", etc. used only for special application or in particular conditions.

9.1.13.1 Time and date

Time and date are used in maintenance functions to associate the time information to the memorized event (torque profile, alarm log, maintenance request, etc.). Time and date are entered at the time of manufacture, but they can be adjusted during commissioning or maintenance operations.

Configuration procedure

- Move the local selector to OFF and then simultaneously press OPEN and STOP. Select the language and enter the password according to the instructions (see "Entering the set-up mode"). When the message displayed is "SET-UP MODE OK?" press YES. Press YES to select actuator set-up menu, press NO to scroll the list of available routines and then press YES to select Miscellaneous.
- Press YES to enter the time and date routine.
- Press YES if the time is correct, press NO to change it.

9.1.13.2 Factory settings

The above routine resets the present configuration and restores the default configuration as below:

| | |
|-----------------|---|
| Stroke limits | Close direction: CW Close limit: by position Open limit: by position |
| Torque set-up | Closing torque: 40% Opening torque: 40% |
| ESD set-up | ESD action: close ESD signal: present ESD priority: - ESD < motor thermostat - ESD < torque limit - ESD < local stop - ESD > local controls - ESD > 2-speed timer - ESD < OFF |
| Remote controls | Control type: 4 wires latched |
| Locals controls | Control type: latched with instant reverse LED's color: - green = open / opening - red = close / closing - yellow = alarm / warning |
| Output relay | Default #1 |
| 2-speed timer | Opening direction: off Closing direction: off |
| Miscellaneous | Lithium battery : absent Torque profile: standard Torque by-pass: 4% Valve jammed: 4 sec. |

Configuration procedure

- Move the local selector to OFF and then simultaneously press OPEN and STOP. Select the language and then enter the password according to the instructions (see "Entering the set-up mode"). When the message displayed is "SET-UP MODE OK?" press YES. Press YES to select the actuator set-up menu, press NO to scroll the list of available routines and then press YES to select Miscellaneous.
- Press No to scroll the list of routines and press YES to select factory configuration. Press YES to download the standard configuration, press NO to exit.

9.1.13.3 Torque limits

Torque limits are used as a reference for torque alarm and end of travel. With the option "standard", the torque limits are constant along the full stroke. The limits can be configured in the "stroke limits" or "torque set-up" routines and determine the torque alarm or end of travel situations. In the same particular application it is useful to configure 3 different torque thresholds for each travelling direction, to limit separately the unseating, running and ending torque. To select this option pick "3-point limits" and then follow the torque set-up and stroke limits routines (see figure).

Configuration procedure

- Move the local selector to OFF and then simultaneously press OPEN and STOP. Select the language and enter the password according to the instructions (see "Entering the set-up mode"). When the message displayed is "SET-UP MODE OK?" press YES. Press YES to select actuator set-up menu, press NO to scroll the list of available routines and then press YES to select Miscellaneous.
- Press NO and then NO to select "torque mode". Press YES if setting is correct, press NO to change. Press YES when the value is correct.
- Repeat stroke limits setting routine.

ACTUATOR DIRECTION: CLOSING

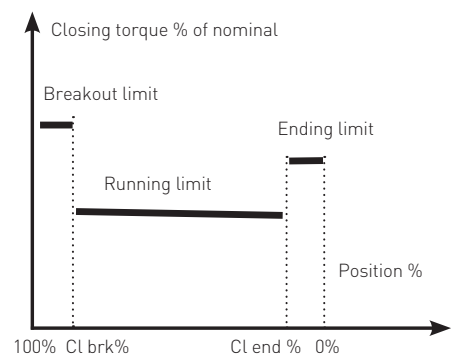

ACTUATOR DIRECTION: OPENING

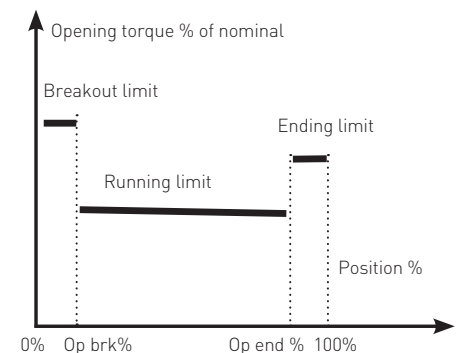

9.1.13.4 Lithium battery

On request, the actuator can be provided with a lithium battery to update the remote outputs (output relays status and bus messages) in case of electrical power failure and manual override operations. The program runs the functions relevant to the battery only if the appropriate flag "lithium battery" is configured with "present". If the battery is absent or if no updating of remote outputs is requested, the above flag should be configured with "absent".

Configuration procedure

- Move the local selector to OFF and then simultaneously press OPEN and STOP. Select the language and enter the password according to the instructions (see "Entering the set-up mode"). When the message displayed is "SET-UP MODE OK?" press YES. Press YES to select actuator set-up menu, press NO to scroll the list of available routines and then press YES to select Miscellaneous.
- Press No to scroll the list of routines and press YES to select lithium battery. Press YES if the setting is correct, press NO to change. Press YES when the value is correct.

9.1.13.5 Torque by-pass (%)

Since a high torque may be required to unseat certain valves, the torque by-pass routine masks the torque alarm when an open or close command is received and the actuator is fully open or closed. The torque by-pass is expressed in % of position and is configurable from 0% to 20%. For example, if a 10% by-pass value is set, we may have:

- by-pass active in Opening: from 0% to 10%
 - by-pass active in Closing: from 100% to 90%
- To exclude torque by-pass configure 0%.

Configuration procedure

- Move the local selector to OFF and then simultaneously press OPEN and STOP. Select the language and enter the password according to the instructions (see "Entering the set-up mode"). When the message displayed is "SET-UP MODE OK?" press YES. Press YES to select actuator set-up menu, press NO to scroll the list of available routines and then press YES to select Miscellaneous.
- Press No to scroll the list of routines and press YES to select torque by pass. Press YES if the setting is correct, press NO to change. Press YES when the value is correct.

9.1.13.6 Valve jammed (time)

The valve jammed time is used to monitor the following situations:

1. The time passed after receiving an open or close control is greater than the "valve jammed time", but the valve position variation is smaller than 0.5%. The motor is blocked, the command is cleared and the "valve jammed" alarm indication is generated.
2. The valve is moving, but during the travel the position valve variation is smaller than 0.5% in a time equal to "valve jammed time". The motor is blocked, the command is cleared and the "mid-travel alarm" indication is generated.

The valve jammed time is expressed in seconds and can be configured from 0 to 100 sec. Configure "0" to exclude the routine.

Configuration procedure

- Move the local selector to OFF and then simultaneously press OPEN and STOP. Select the language and enter the password according to the instructions (see "Entering the set-up mode"). When the message displayed is "SET-UP MODE OK?" press YES. Press YES to select actuator set-up menu, press NO to scroll the list of available routines and then press YES to select Miscellaneous.
- Press No to scroll the list of routines and press YES to select valve jammed. Press YES if the setting is correct, press NO to change. Press YES when the value is correct.

9.2 VALVE DATA

The valve data allow identifying the valve and its function in the process. The valve manufacturer and the end user can enter the data. The following data can be entered:

- Tag name (max. 28 characters)
- Serial number (max. 28 characters)
- Manufacturer (max. 28 characters)
- Break OP torque (max. 28 characters)
- Break CL torque (max. 28 characters)
- Max stem thrust (max. 28 characters)
- Flange type (max. 28 characters)

9.2.1 Sample configuration procedure

Tag name

- Move the local selector to OFF and then simultaneously press OPEN and STOP. Select the language and enter the password according to the instructions (see "Entering the set-up mode"). When the message displayed is "SET-UP MODE OK?" press YES. Press NO to scroll the list of available menus and then press YES to select valve data menu.
- Press NO to scroll the list of available routines and then press YES to select Tag name.
- Press YES if the 1st character of the string is correct. Press NO to scroll the list of available characters. Press YES to select the desired character.
- Enter up to 28 characters. Enter a blank character, and "←" as end of string.

The configuration of all other valve data items is made in the same way, by selecting the relevant item from the list of available routines.

9.3 MAINTENANCE

A large amount of data is stored in the actuator memory and is available for future analysis or to assist the operator in the maintenance program. The maintenance menu also includes the set password routine and the possibility to modify or start the maintenance functions.

The following data are available:

- set password
- clear alarm log
- set torque reference
- set curve reference
- clear recent data log
- set maintenance date
- set data logger

9.3.1 Set password

The actuator is supplied by Biffi with a default password ("0 0 0 0"). By the above routine the end user can enter a different password consisting of 4 alphanumeric characters. After entering the new password, the old one ceases to be valid. Therefore it is mandatory "NOT TO FORGET THE PASSWORD" after the default one has been modified. Forgetting the new password makes it impossible to enter the set-up menu and to configure the actuator.

Configuration procedure

- Move the local selector to OFF and then simultaneously press OPEN and STOP. Select the language and enter the password according to the instructions (see "Entering the set-up mode"). When the message displayed is "SET-UP MODE OK?" press YES. Press NO to scroll the list of available menus and then press YES to select Maintenance menu.
- Press NO to scroll the list of available routines and then press YES to select Set password. Press YES again to select Enter new password.
- Enter the new password one digit at a time. Press YES if the digit is correct, press NO to scroll the list of available characters and then press YES to select. Enter 4 digits. When the display shows the message Password changed the old password is no longer valid.

9.3.2 Clear alarm log

Clear procedure

- Move the local selector to OFF and then simultaneously press OPEN and STOP. Select the language and enter the password according to the instructions (see "Entering the set-up mode"). When the message displayed is "SET-UP MODE OK?" press YES. Press NO to scroll the list of available menus and then press YES to select the Maintenance menu.

- Press NO to scroll the list of available routines and then press YES to select clear alarm log.
- Press YES to clear alarm log.

9.3.3 Set torque reference

The set torque profile reference routine allows to transfer the last torque profile to the reference profile registers. The old reference data are lost and the new ones are used as a new reference torque profile.

- Move the local selector to OFF and then simultaneously press OPEN and STOP. Select the language and enter the password according to the instructions (see "Entering the set-up mode"). When the message displayed is "SET-UP MODE OK?" press YES. Press NO to scroll the list of available menus and then press YES to select maintenance menu.
- Press NO to scroll the list of available routines and then press YES to select Set torque reference.
- Press YES to update the torque reference data.

9.3.4 Set curve reference

The "set curve reference" routine allows to select 1 off 100 opening and closing torque curves in the memory of the ICON 2000 and to transfer them to the torque curve reference registers. The old reference data are lost and the new ones will be the new torque curves reference (see VIEW mode, Maintenance, Torque curve, paragraph 10.4.3).

Configuration procedure

- Move the local selector to OFF and then simultaneously press OPEN and STOP. Select the language and then enter the password according to the instructions (see "Entering the set-up mode"). When the message displayed is "SET-UP MODE OK?" press YES. Press NO to scroll the list of available menus and then press YES to select maintenance menu.
- Press NO to scroll the list of available routines and then press YES to select Set curve reference.
- Press NO to scroll the list and then press YES to select the desired curves (in opening and closing).
- Press YES to update the torque curve reference.

9.3.5 Clear recent data log

The clear recent data log routine allows to clear the counters of the recent operation log. This command does not affect the content of the "general operation log".

The date of the "clear recent data log" is memorized and can be viewed in the maintenance date routine of the view menu.

Clearing procedure

- Move the local selector to OFF and then simultaneously press OPEN and STOP. Select the language and enter the password according to the instructions (see "Entering the set-up mode"). When the message displayed is "SET-UP MODE OK?" press YES. Press NO to scroll the list of available menus and press YES to select the maintenance menu.
- Press NO to scroll the list of available routines and then press YES to select clear recent data log.
- Press YES.
- Press YES to clear or press NO to exit.

9.3.6 Set maintenance date

The maintenance date routine allows the following operations:

- to set the last maintenance date
- to set the next maintenance date
- to set the start-up date

Configuration procedure

- Move the local selector to OFF and then simultaneously press OPEN and STOP. Select the language and enter the password according to the instructions (see "Entering the set-up mode"). When the message displayed is "SET-UP MODE OK?" press YES. Press NO to scroll the list of available menus and then YES to select the maintenance menu.
- Press NO to scroll the list of available routines and press YES to select maintenance date.
- Press YES to set the last maintenance date. Press NO to skip to "next maintenance date".

Last maintenance date

- Press YES if the date is correct, press NO to change it.
- Enter day, month, and year. Press NO to scroll the list of available values, press YES to select.
- Press YES if the date is correct.

Next maintenance date

- Press YES if the date is correct, press NO to change it.
- Enter day, month, and year. Press NO to scroll the list of available values, press YES to select.
- Press YES if the date is correct.

Start-up date

- Press YES if the date is correct, press NO to change it.
- Enter day, month, and year. Press NO to scroll the list of available values, press YES to select.
- Press YES if the date is correct.

9.3.7 Set data logger

The "data logger" routine allows to set the data logger parameters (see VIEW mode, Maintenance, Data logger, paragraph 10.4.6). To start the data logger the following data should be set:

| | |
|---------------|---|
| Logger mode | recorder, event, off |
| Sampling time | from 1 to 3600 secs (the sampling time is only used in recorder mode) |
| Memory mode | stop when memory is full, continuous (stop after overwriting the memory 5000 times (event) and 10000 times (recorder/T-recorder)) |
| Start date | date when the logger starts |
| Start time | time when the logger starts |

Configuration procedure

- Move the local selector to OFF and then simultaneously press OPEN and STOP. Select the language and then enter the password according to the instructions (see "Entering the set-up mode"). When the message displayed is "SET-UP MODE OK?" press YES. Press NO to scroll the list of available menus and then press YES to select maintenance menu.
- Press NO to scroll the list of available routines and then press YES to select "data logger".
- Press YES if the mode is correct. Press NO to scroll the list of modes and press YES to select the desired value .
- Press YES if the sampling time is correct. Press NO to scroll the list of times and press YES to select the desired value.
- Press YES if the memory mode is correct (stop when full or continuous). Press NO to change and press YES to select.
- Press YES if the start time is correct. Press NO to scroll the list and press YES to select the desired sampling times (hour, min, sec).
- Press YES if the start date is correct. Press NO to scroll the list and press YES to select the desired sampling times (day, month, year).
- Press YES to confirm the above settings.

10 VIEW ROUTINES

10.1 ACTUATOR SET-UP

The above menu allows to view the present actuator configuration. No change can be made to the present data. The following data can be viewed (see table).

View procedure

- Move the local selector to OFF and then simultaneously press OPEN and STOP. Select the language according to the instructions (see "Entering the view mode"). When the message displayed is "VIEW MODE OK?" press YES. Press YES to select the actuator set-up menu.
- Press NO to scroll the list of available routines and press YES to select.
- Press YES to answer at the prompt "view" or "next" and to see the data.

10.2 NAME PLATE

Use this menu to view the data identifying the actuator. The data are entered in-house and can only be changed by the manufacturer. The following data may be viewed:

- Serial number: max. 28 characters, univocal identifier of the actuator by reference to Biffi acknowledgment.
- Actuator type: max. 28 characters, describes the type of actuator with reference to Biffi catalog.
- Torque / Thrust: nominal torque or thrust of actuator.
- Actuator speed: nominal speed of actuator.
- Speed Loop: parameters to set the speed loop (for ICON LP only)
- Power supply: nominal voltage and frequency of actuator.
- Motor data: includes the following data relevant to the electrical motor:
 - Power type (3ph, 1ph, dc)
 - Power rating, max. 99.9 kW
 - In, max. 99.9 A
 - Is, max. 99.9 A/KT (for ICON LP)
 - Icc, max 999.9 A/TMax (for ICON LP)
 - Duty (S2/15 min, etc.)
 - Poles (2, 4, etc.)
 - Biffi name, max. 28 characters
 - Gear ratio, max. 1000 /M.R. Ratio (for ICON LP)
- Test date: date of the in-house functional test of actuator.
- Wiring diagram (WD): wiring diagram number, max 28 characters.
- Enclosure: type of enclosure (Ex d, etc.), max. 28 characters.
- Certificate: number of certificate, max. 28 characters.

| Routine | Parameters |
|-----------------|--|
| Stroke limits | Close direction (CW, CCW), close limit type (torque or position), open limit type (torque or position) |
| Torque set-up | Closing torque limit %, opening torque limit % |
| ESD control | ESD action, signal type, ESD priority |
| Remote controls | Control type |
| Local controls | Control type, LED's color |
| Output relays | Monitor relay conditions, ASi conditions, contact action |
| Positioner * | Dead band, motion inhibit time, polarity, %min, %max [%min and %max are present only if "position request R%" is from 4-20 mA input] |
| Fail Safe * | Action, delay |
| Out 4-20 mA * | Output signal (position or torque), polarity |
| Interlock | Signal type in OP, signal type in CL |
| 2-speed timer | Close direction: status, start, stop, on time, off time Open direction: status, start, stop, on time, off time |
| Bus * | Node address, terminations, etc. depending on fieldbus type |
| Miscellaneous | Time and date, torque mode, lithium battery, torque by pass %, valve jammed time |

The routines with * can only be viewed if the relevant electronic cards are present. If the bus interface is LonWorks, routine "BUS" changes to "FDI control". Detailed descriptions of the above routines and their parameters can be found in chapter 9.

- Lubricant: type of lubricant, max. 28 characters.
- Revision: HW revision of base card, SW revision of H8 microprocessor, SW revision of PIC microprocessor.
- Torque sensor: data relevant to the relationship between motor torque and speed. This set of data also includes the factory torque limit setting, "Torque set CL" and "Torque set OP".

View procedure

- Move the local selector to OFF and then simultaneously press OPEN and STOP. Select the language according to the instructions (see "Entering the view mode"). When the message displayed is "VIEW MODE OK?" press YES. Press NO to scroll the list of available menus and press YES to select the nameplate menu.
- Press YES to answer the prompt "view" or "next" and see the data in the above list.

10.3 VALVE DATA

To identify the valve and its function in the process the following data can be viewed:

- Tag name (max. 28 characters)
- Serial number (max. 28 characters)
- Manufacturer (max. 28 characters)
- Break OP torque (max. 28 characters)
- Break CL torque (max. 28 characters)
- Max stem thrust (max. 28 characters)
- Flange type (max. 28 characters)

The data should be entered by the valve manufacturer or by the end user during set-up operations.

View procedure

- Move the local selector to OFF and then simultaneously press OPEN and STOP. Select the language according to the instructions (see "Entering the view mode"). When the message displayed is "VIEW MODE OK?" press YES. Press NO to scroll the list of available menus and press YES to select the valve data menu.
- Press YES to answer prompts "view" or "next" and see the data in the above list.

10.4 MAINTENANCE

10.4.1 Alarm log

The alarm log routine is used to view the list of the latest 5 alarms and 5 warnings and the data when they occurred. The "clear alarm log" routine of the set-up menu should be used to clear the list.

View procedure

- Move the local selector to OFF and then simultaneously press OPEN and STOP. Select the language according to the instructions (see "Entering the view mode"). When the message displayed is "VIEW MODE OK?" press YES. Press NO to scroll the list of available menus and press YES to select the Maintenance menu.
- Press YES to answer the prompt "Alarm log view?".
- Press YES to scroll the list of alarms ("Alarms view?").
- Press NO to move on to "Warnings view?" and then YES to scroll the list of warnings.

10.4.2 Torque profile

The torque profile routine gives important information on the actuator working conditions in comparison with a previously memorized reference profile. It can give an indication of a change in the process conditions.

Details are given of the reference and latest torque expressed in % of the nominal torque.

At the end of a full stroke in opening or closing the ICON 2000 stores the 3 maximum torque values in position intervals 0%-10%, 10%-90%, 90%-100% in opening, and the 3 maximum torque values in position intervals 100%-90%, 90%-10%, 10%-0% in closing. Time and date of strokes are also saved. The above data are updated at the end of every full valve stroke and the previous ones are lost. Function "set torque reference", in the SET-UP MENU, Maintenance, (chapter 7), allows to save the "torque profile" data in the "torque profile reference" with date and time. The "torque profile reference" will not be updated until a new "set torque reference" command is entered. The user can compare the last torque profile relevant to the last valve stroke with the torque profile reference saved before.

The following definitions will be used:

- Breakout: maximum torque % in position interval 0-10% in opening or 100%-90% in closing = max. % of torque to unseat the valve.
- Peak running: maximum torque % in position interval 10-90% in opening or 90%-10% in closing = max. % of torque when the valve runs from Breakout to Ending (maximum mid-travel).
- Ending: maximum torque % in position interval 90-100% in opening or 10%-0% in closing = max. % of torque to seat the valve.

The following data may be viewed:

Closing torque

- Breakout %
- Breakout reference %
- Peak run %
- Peak run reference %
- Ending %
- Ending reference %
- Date of the last stroke
- Date of reference (same of opening)

Opening torque

- Breakout %
- Breakout reference %
- Peak run %
- Peak run reference %
- Ending %
- Ending reference %
- Date of the last stroke
- Date of reference (same of closing)

View procedure

- Move the local selector to OFF and then simultaneously press OPEN and STOP. Select the language according to the instructions (see "Entering the view mode"). When the message displayed is "VIEW MODE OK?" press YES. Press NO to scroll the list of available menus and press YES to select the Maintenance menu.
- Press NO to scroll the list of routines and press YES to select torque profile.
- Press YES to scroll the list of values.

10.4.3 Torque curve

The torque curve routine gives important information on the actuator working conditions in comparison with a previously memorized reference torque curve. It can be used to perform a detailed analysis of a change in the process conditions.

During a full valve stroke in opening or closing, the ICON 2000 measures the torque values relevant to every 1% of position variation. At the end of the stroke the collected 101 values (one torque value every 1% of position change) are saved in the ICON 2000 memory together with the time and date of strokes, main voltage, motor temperature, temperature inside the electronics compartment and temperature inside the terminal board compartment. Up to 100 curves in opening and 100 curves in closing can be saved. When a new curve is available the oldest one is cancelled and the new one is memorized. The above data are updated at the end of every full valve stroke. Data relevant to a partial stroke are discharged. Function "set curve reference", in the SET-UP MENU, Maintenance, chapter 7, allows to save the full set of data relevant to 1 off 100 "torque curves" in the "torque curve reference". The "torque curve reference" will not be updated until a new "set curve reference" command is entered. The user can compare the last 100 torque

curves in opening and closing relevant to the last 200 valve strokes with the torque curve reference saved before.

Below is the list of saved data for each opening or closing curve:

| | |
|------------------------|---|
| Date | Date of the valve stroke |
| Time | Time of the valve stroke |
| Temperature | Temperature (°C) inside the electronics compartment during the valve stroke |
| Term temp | Temperature (°C) inside the terminal board compartment during the valvestroke |
| Motor temp | Temperature of the electrical motor (°C) during the valve stroke |
| Main voltage | Main voltage supply (V) during the valve stroke |
| Closing / Opening time | |
| Torque 0 | Torque value in % of the nominal torque / thrust stated in the Name Plate menu. In opening "Torque 0" corresponds to position 0% and in closing "Torque 0" corresponds to position 100% |
| Torque 100 | Torque value in % of the nominal torque / thrust stated in the Name Plate menu. In opening "Torque 100" corresponds to position 100% and in closing "Torque 100" corresponds to position 0% |

The amount of data to be viewed is large and the local display can only visualize one datum at a time. To use this function we suggest to utilize the features available with PDA's and PC through Bluetooth™ wireless connection. The figure below shows an example of graph available on PDA or PC screen, showing the reference opening torque curve and the latest opening torque curve.

View procedure

- Move the local selector to OFF and then simultaneously press OPEN and STOP. Select the language according to the instructions (see "Entering the view mode"). When the message displayed is "VIEW MODE OK?" press YES. Press NO to scroll the list of available menus and press YES to select the Maintenance menu.
- Press NO to scroll the list of routines and press YES to select torque curve.
- Press NO to scroll the list of available curves (from 1 to 5 and reference). The curve 1 is the latest and the curve 5 is the oldest. Press YES to select.
- Press YES to select the opening or closing curve. Press NO to exit.
- Press YES to scroll the list of values. Press NO to exit.

10.4.4 Operation log

The operation log consists of different counters and routines that provide information to assist in the maintenance program. The data are grouped into 2 families: general and recent data. The general data log collects data from "test date" to "present date". The test date is set in house, can be viewed in the "name plate" menu but cannot be changed. The recent data log collects data from the last "clear recent data log" date to "present date".

Command "clear recent data log" is available in the SET-UP MENU, maintenance, chapter 7. This command clears the content of the recent data log and resets the counters to 0. The old data are lost.

The main differences between "general" and "recent" data log are the following:

- The general data log gives information relevant to the full life of the actuator, starting from the manufacturing date.
- In the recent data log the same data are collected starting from a date set by the user. The date may be viewed in the MAINTENANCE DATE paragraph.

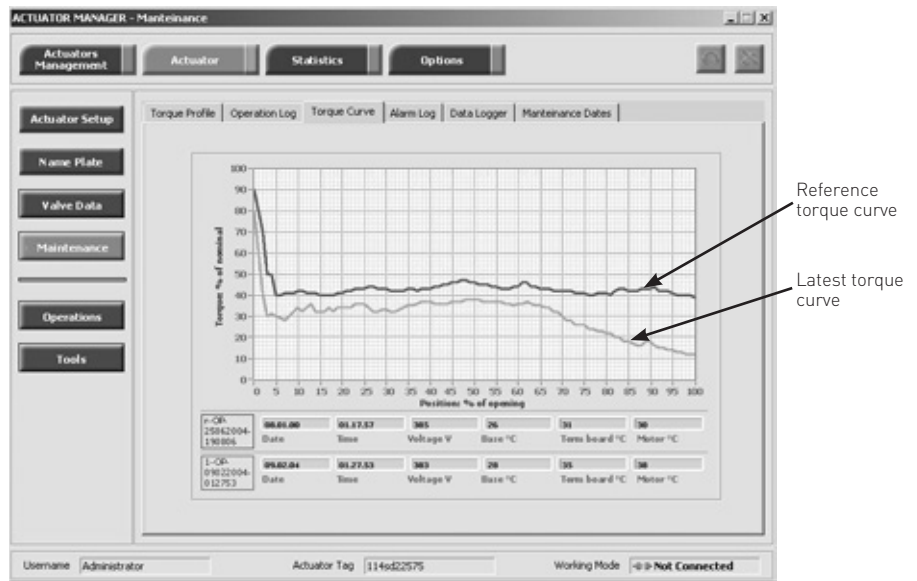

Below is the list of data collected by the general and recent data log.

| General data | Recent data log |
|-------------------|-------------------|
| Opening time | |
| Closing time | |
| Contactur cycles | Contactur cycles |
| Motor run time | Motor run time |
| No power time | No power time |
| Utilisation rate | Utilisation rate |
| Temperature min | Temperature min |
| Temperature max | Temperature max |
| Term temp min | Term temp min |
| Term temp max | Term temp max |
| Motor temp max | Motor temp max |
| Thermostat alarms | Thermostat alarms |
| Torque alarms | Torque alarms |

View procedure

- Move the local selector to OFF and then simultaneously press OPEN and STOP. Select the language according to the instructions (see "Entering the view mode"). When the message displayed is "VIEW MODE OK?" press YES. Press NO to scroll the list of available menus and press YES to select the Maintenance menu.
- Press NO to scroll the list of available routines and press YES to select operation log.
- Press YES to select general data or press NO to skip to recent data.
- Press YES to scroll the list of values.
- Press YES to view the recent data log or press NO to exit.
- Press YES to scroll the list of values.

| | |
|-------------------|---|
| Opening time | This datum is only available in the general data log. It is updated at the end of every full valve stroke of the valve in opening direction. The data of the previous stroke are lost. It gives the time necessary to the valve to move from the close position to the open position, expressed in hours, minutes and seconds. |
| Closing time | This datum is only available in the general data log. It is updated at the end of every full valve stroke of the valve in closing direction. The data of the previous stroke are lost. It gives the time necessary to the valve to move from the open position to the close position, expressed in hours, minutes and seconds. |
| Contactors cycles | This number counts the cycles of contactors K1 and K2. The value indicated in the general data log is also used to generate the "max. contactor cycles" warning when the maximum allowable number of cycles of the contactor is reached (see paragraph 12.11, Diagnostic messages). If the main power is DC or single phase and in modulating actuators, the counters (general and recent) are hold to 0. |
| Motor run time | This number counts the hours with motor energized. |
| No power time | This number counts the hours without electrical power. |
| Utilization rate | This number % is incremented every 200 full strokes of the actuator. It reaches 100% after 20 000 full strokes. |
| Temperature min | This is the lowest temperature value (in °C) measured inside the electronics compartment. |
| Temperature max | This is the highest temperature value (in °C) measured inside the electronics compartment. |
| Term temp min | This is the lowest temperature value (in °C) measured inside the terminal board enclosure. |
| Term temp max | This is the highest temperature value (in °C) measured inside the terminal board enclosure. |
| Motor temp max | This is the highest temperature value (in °C) measured in the electrical motor. |
| Thermostat alarms | This counts the number of alarms due to the high temperature of the electrical motor and to the tripping of the motor thermostat. |
| Torque alarms | This counts the number of alarms due to high torque in opening and closing. |

10.4.5 Maintenance date

The routine allows viewing the following dates:
 - Last date
 - Next date
 - Start-up date
 - Recent log date
 (see table below)

View procedure

- Move the local selector to OFF and then simultaneously press OPEN and STOP. Select the language according to the instructions (see "Entering the view mode"). When the message displayed is "VIEW MODE OK?" press YES. Press NO to scroll the list of available menus and press YES to select the Maintenance menu.
- Press NO to scroll the list of available routines and press YES to select the maintenance date routine.
- Press YES to scroll the list of dates.

10.4.6 Data logger

The "data logger" routine allows to collect different types of data useful in maintenance or in diagnostic programs. Since the amount of collected data is very large, the data logger can only be viewed by means of a PDA or PC. The data can be up-loaded from ICON 2000 to PDA or PC by the Bluetooth™ wireless connection. The local display only allows to view the value of the configured parameters (see also SET-UP menu, Maintenance, Set data logger, paragraph 9.3.7). The following data can be viewed on the local display:

- Logger mode
- Sampling time
- Memory mode
- Date
- Time

Data logger modes:

- OFF: the data logger is not active.
- RECORDER mode: the ICON 2000 measures and memorizes the following 3 data:
 - Main voltage supply (V)
 - Motor temperature (°C)
 - Temperature inside the compartment of electronics (°C)
- T-RECORDER mode: the ICON 2000 measures and memorizes the following 3 data:
 - Torque in OP/CL
 - Motor temperature (°C)
 - Voltage

In RECORDER and T-RECORDER mode the SAMPLING TIME fixes the time interval among two sets of measures. Up to 256 sets of measures (equivalent to 256x4 samples) can be memorized. The sampling time can be configured from 1 to 3600 secs. As the memory is full, the recorder stops recording or overwrites the previous data according to the selected MEMORY MODE ("stop when full" or "continuous"). If "continuous" was selected, as a new set of measures is achieved the oldest one is cancelled and the new one becomes the latest. Up to 10000 cycles of full memory overwriting are done, then the recorder stops. In T-RECORDER mode, the recording operation is also stopped in case of OVER-TORQUE ALARM, in opening or in closing. This additional feature allows to maintain in the memory the last 256 samples and see the trend of torque, motor temperature and main voltage before the alarm. A new start of T-RECORDER clears the data stored in the memory. By a PDA or PC the recorded data can be viewed by a graph where time is on the X axis and the measured data on the Y axis.

| | |
|-----------------|--|
| Last date | This is the date of the last maintenance operation. The date should be updated by the user after all maintenance operations (see paragraph 9.3). |
| Next date | This is the date of the next scheduled actuator maintenance. When the date is reached, the ICON 2000 generates a maintenance request warning. The date should be updated by the user after all maintenance operations (see paragraph 9.3). |
| Start-up date | This is the date of actuator start-up. During commissioning, the user should enter the start-up date (see paragraph 9.3). |
| Recent log date | This is updated after entering command "Clear recent data log" (see paragraph 9.3). This command clears the "recent data log" counters. The content of "recent log" is updated starting from "recent log date". |

The figure below shows a graph with sampling time 2 secs in RECORDER mode.

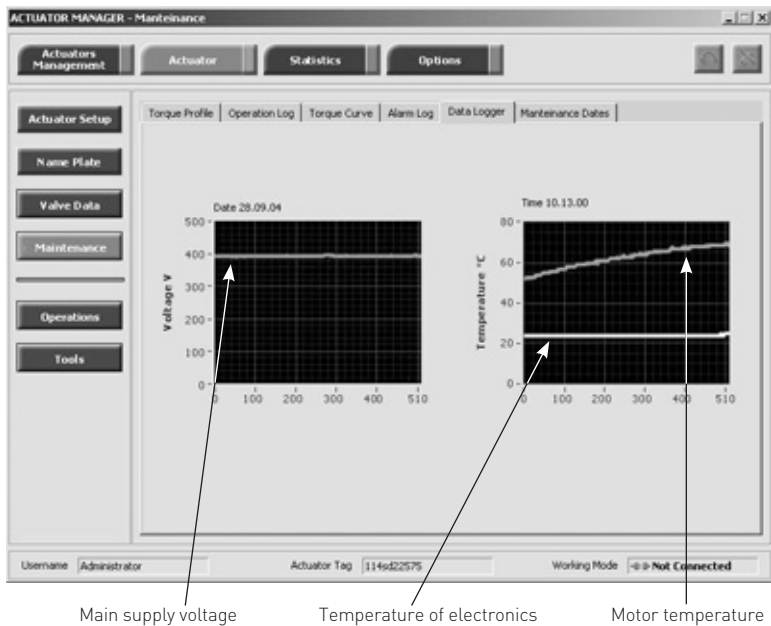

The figure below shows a graph with sampling time 1 sec in T-RECORDER mode after a recording stop for OVER-TORQUE alarm:

1. Torque limit in OP reached
2. Curve selector:
 - Torque
 - Motor temperature
 - Main voltage

Torque limit in CL is set to 90%, torque limit in OP is set to 100%. Blue graph shows Torque OP versus time, yellow graph shows Torque CL versus time. The data remain in the ICON 2000 v4 permanent memory until a new start of data logger is set.

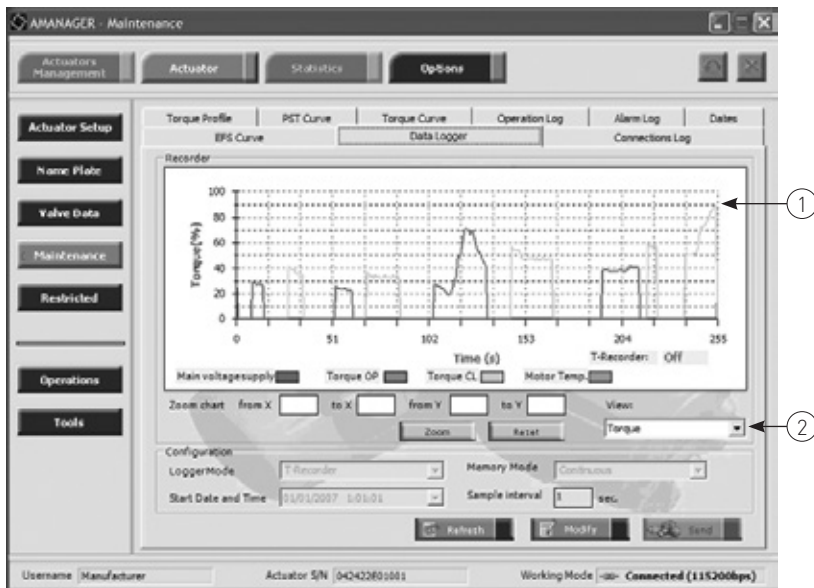

- **EVENT mode:** the ICON 2000 detects the type of received command (OPEN or CLOSE), the source of the command (local controls, remote controls, bus, etc.) and date and time of command. Up to 128 EVENTS can be memorized. As the memory is full, the logger stops to memorize events or overwrites the previous data according to the selected MEMORY MODE ("stop when full" or "continuous"). If "continuous" was selected, as a new event is achieved the oldest one is cancelled and the new one becomes the latest. Up to 50 cycles of full memory overwriting are done, then the logger stops. The START DATE and START TIME fix date and time to start recording operation. By a PDA or PC the collected data can be viewed by a graph or event table. Parameter "sampling time" is not used. The figure below shows an example of report in EVENT mode.

View procedure

- Move the local selector to OFF and then simultaneously press OPEN and STOP. Select the language according to the instructions (see "Entering the view mode"). When the message displayed is "VIEW MODE OK?" press YES. Press NO to scroll the list of available menus and press YES to select maintenance menu.
- Press NO to scroll the list of routines and press YES to select data logger.
- Press YES to view the MODE, the SAMPLING time, the MEMORY mode, the start DATE and the start TIME.
- Press YES to return data logger. Press NO to exit.



10.5 EXAMPLE OF VIEW ROUTINE

10.5.1 View torque set-up

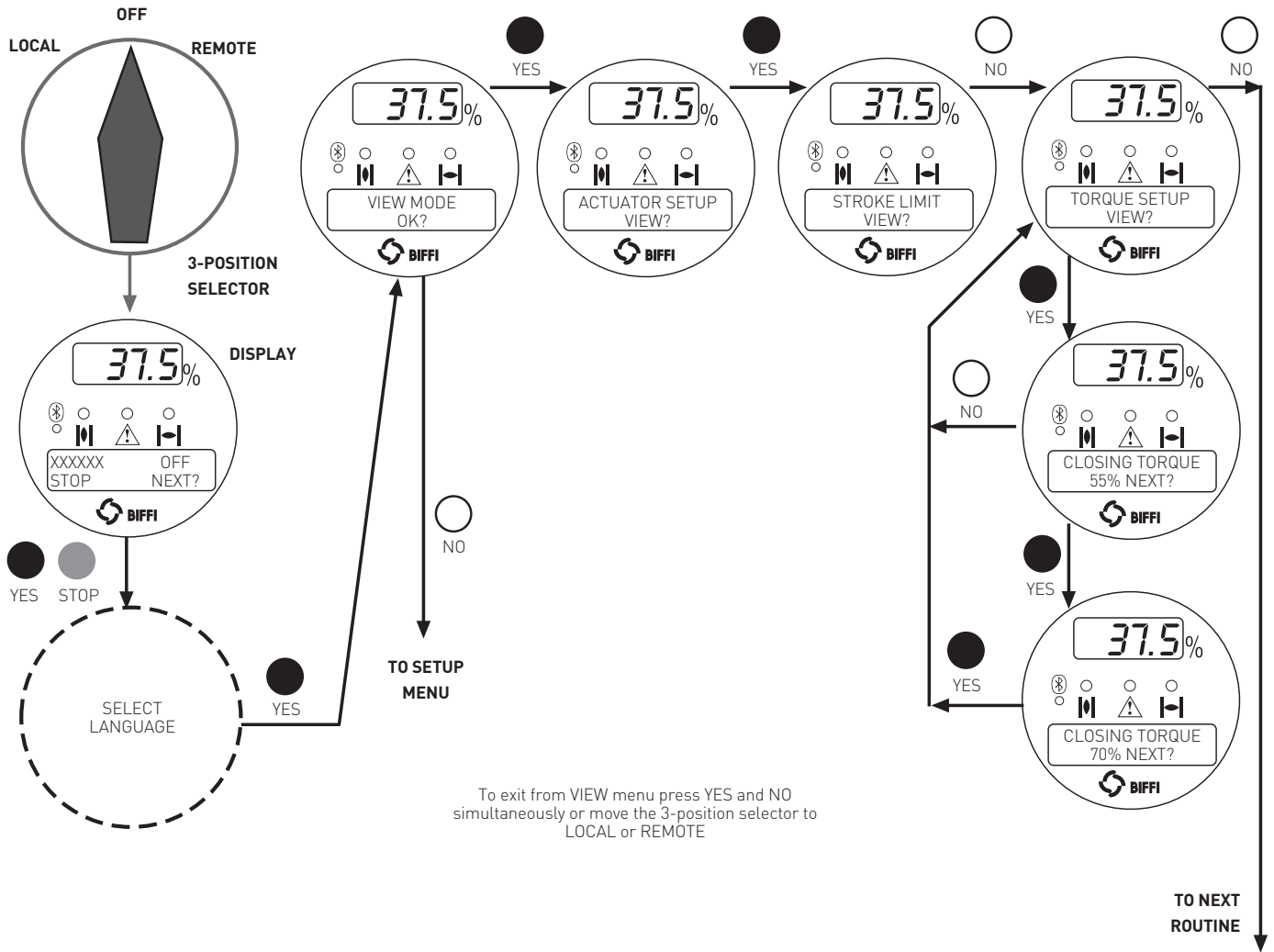

11 MAINTENANCE

11.1 STANDARD MAINTENANCE

Approx. every 2 years:

Under normal operating conditions, the ICON 2000 is maintenance-free: no actuator maintenance is formally required, even though visual inspection for oil leakage or external visible damages is recommended every two years. When conditions are severe (frequent operation or high temperatures), inspect the oil level and oil quality more often. Replace all seals that permit oil leakage or water ingress.

IMPORTANT

Before starting any maintenance operation, make sure that the mains and all other service voltage connected to terminal board are switched-off.

WARNING

The actuator is non-intrusive. The control compartment was sealed in dry and clean conditions and contains no site serviceable components. Do not open it unless absolutely necessary. Unauthorized access will invalidate the warranty.

WARNING

Since the control compartment contains a 3.6V lithium battery, only open it in safe area. If the actuator is located in a hazardous area a "hot work" permit must be obtained unless the actuator can be moved to a non-hazardous area.

The following checks will assure optimum performance:

- If the stem is external, check that the valve stem is clean and lubricated. If not, clean it and lubricate it in order to prevent damages to the threaded bush.
- Lubricate the internal components of the coupling block by means of the spherical head lubricator using suggested greases (see chapter 4, Lubrication).
- Make sure there are no oil leaks from the actuator housing. The oil level should be approx. 20 mm from the fill plug (see chapter 4, Lubrication).
- Check the external parts for possible damage and replace them immediately, if necessary. In case the window glass is broken, the complete cover must be replaced (see chapter 13, Parts list and drawings for individual item numbers).
- Repaint all areas where paint is missing. In chemically aggressive or saline environments, remove rust from surfaces and protect with a rust preventative.

- Check that all nuts and bolts securing the actuator to the valve are tight. If necessary, re-tighten with a dynamometric key (for tightening torque values see paragraph 3.4.3, Installation - Mounting the actuator onto the valve - Actuator fixing).
- For severe applications or if actuator operation is infrequent, perform maintenance checks more often.
- For actuators provided with lithium batteries, make sure that the display is still visible when power is off and that there is no "Battery low" warning message. If "Battery low" warning appears, replace the battery (see paragraph 11.3 Maintenance - Lithium battery change).
Always replace batteries if the actuator has been subjected to long periods without power (see chapter 12, Troubleshooting).

11.2 SPECIAL MAINTENANCE

In case actuator failure, please refer to chapter 12, Troubleshooting for possible causes.

Spare parts can be required to Biffi: please refer to the individual item number shown in chapter 13, Parts list and drawings.

NOTE

Special maintenance is also recommended when, during operations, the actuator generates an excessive noise.

11.3 LITHIUM BATTERY CHANGE

- Isolate the main supply to the actuator and all other control voltages.
 - Open the terminal boards cover.
 - Disconnect two wires (+) (-) from the main board.
 - Bring the cover to a safe area. When in a safe area:
- Remove the label.



WARNING

If the actuator is located in a hazardous area a "hot work" permit must be obtained unless the actuator can be moved to a non-hazardous area.

IMPORTANT

The new battery must be the same type as the one provided: Lithium – SAFT LS 9V.

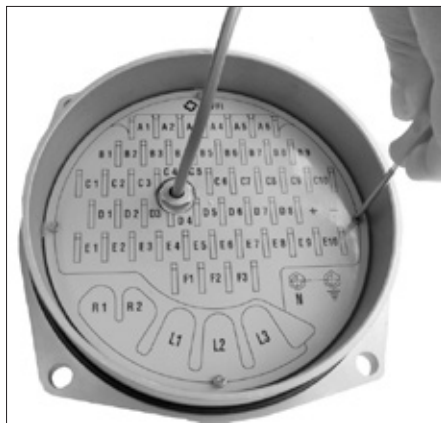

- Remove the battery cover.

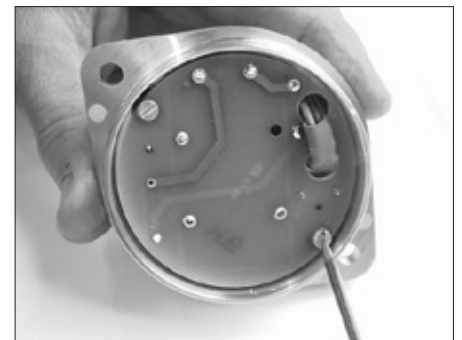
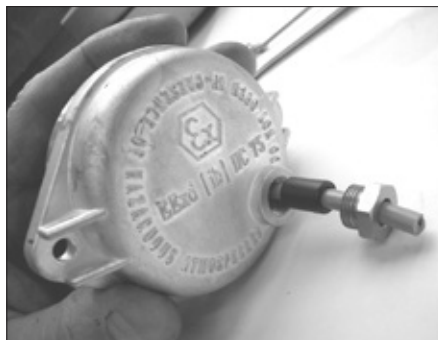

- Replace the battery.



12 TROUBLESHOOTING

The ICON 2000 actuator has passed the functional test performed by Biffi Quality Assurance personnel.

WARNING

The actuator is non-intrusive. The control compartment was sealed in dry and clean conditions and contains no site serviceable components. Do not open it unless absolutely necessary. Unauthorized access will invalidate the warranty.

WARNING

Since the control compartment contains a 3.6V lithium battery, only open it in safe area. If the actuator is located in a hazardous area, a "hot work" permit must be obtained unless the actuator can be moved to a non-hazardous area.

If the actuator does not work, before troubleshooting make sure that:

- the numeric display indicates xx %;
- the local selector is not in OFF;
- the main supply voltage is the same as stated in the name plate menu;
- you move the local selector to OFF and check that the alphanumeric display shows one of the following messages:
 - "normal off"
 - "alarm off"
 - "warning off"
 - "ESD ON off"
 - "INT off"

If the above checks are satisfactory try to locate the fault using the diagnostic facilities.

12.1 THE ELECTRONICS DO NOT SWITCH ON WHEN POWERED

- Check that the value of the main voltage on terminals L1, L2, L3 is correct.
- Remove the cover of the compartment where the electronic cards are located.
- Check the fuse mounted on the power card. Replace it if burnt.
- If the fuse is OK, check the wires between terminals L1, L2, L3 and connector M1 of the power card. If it is correct, replace the power card.

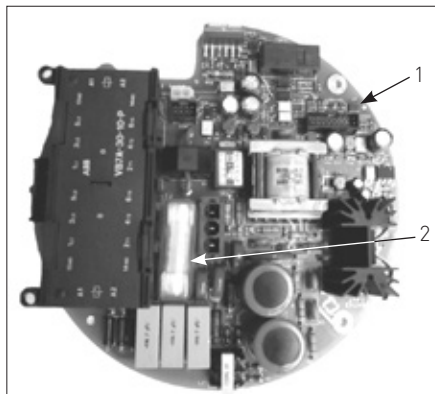

1. Power card
2. Fuse



12.2 DC OUTPUT VOLTAGE NOT AVAILABLE AT THE TERMINALS

- Switch the main power supply off and disconnect all wires from terminals B1-B2 and C1.
- Switch the main power supply on and check if the voltage on the terminals B1-B2 and C1 is between 23 and 27 V DC.
- If the voltage is correct check the external wiring and the electrical load. It should not exceed 4 W.
- If the voltage is not correct replace the power card.

12.3 THE ACTUATOR DOES NOT WORK FROM REMOTE CONTROLS

- Move the 3-position selector to LOCAL and check that the actuator works from local controls.
- Move the local selector to REMOTE. If the ESD signal is active, the alphanumeric display indicates "ESD On". Check the signal on terminals C3 and C4 and adjust the ESD configuration. If the alphanumeric display indicates "INT", an interlock control is present. Check the signal on terminals B3, B4 and B5, and adjust Interlocks configuration.
- Check that:
 - the wiring to terminals B1-B2 and C1 is correct;
 - there is no short-circuit between wires;
 - the electrical load does not exceed 4 W;
 - the value is in the range 20-120 V AC 50/60 Hz or 20-125 V DC, if external voltage supply is used.

12.4 THE MOTOR IS VERY HOT AND DOES NOT START

- Check that no alarm other than motor overheating is present.
- Wait until the motor cools down and the normally closed contact of the thermal switch automatically resets before trying to operate the actuator again.
- Check that the number of operations per hour and their duration is suitable for the actuator service (see the name-plate menu).
- Check that the valve operating torque is within the range of the unit's designed operating torque.
- Always check the causes of abnormal operation.

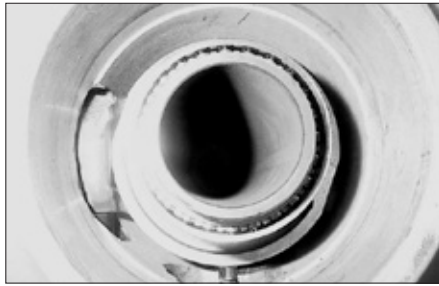
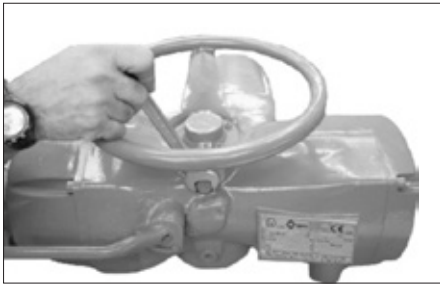

12.5 THE MOTOR RUNS BUT THE ACTUATOR DOES NOT MOVE THE VALVE

In case the local display does not change the valve position indicators:

- Check that the manual de-clutch lever is not stuck in manual operation position.
- Rotate the handwheel a few degrees to remove all possible sticking between the handwheel and the drive sleeve.

In case the local display changes the valve position indicators:

- Verify the stem nut correctly fits in the actuator base.
- Verify the stem nut has sufficient engagement with the valve stem.
- Verify the key correctly fits in bore/keyways applications.
- Check that the valve works in manual operation. If not, it is necessary to check the manual control area as follows:
 - Loosen the handwheel security dowel.
 - Remove the handwheel.
 - Remove the cover supporting the handwheel.
 - Check the integrity of the internal parts.
 - Proceeding with the assembly, follow the reverse order of the disassembly.
 - Make sure there are no foreign bodies. Pay attention not to damage the O-ring seals.

12.6 THE MANUAL OVERRIDE CANNOT BE ENGAGED

In case the engagement of the lever is too difficult, check whether the drive sleeve is stuck and proceed as follows:

- Open the cover.
- Try to move the drive sleeve by a screw-driver.
- Reassemble the cover.

12.7 THE VALVE DOES NOT SEAT CORRECTLY

- If the valve is stopped by the torque limit in closing, increase the actuator output torque limit.
- If the valve is stopped by the position limit in closing, check that the valve reaches its seat position, then readjust the setting of the position limit.
- The internal trim of the valve may be damaged.

12.8 EXCESSIVE TORQUE FOR VALVE OPERATION

- Clean, lubricate and check the valve stem.
- Valve packing too tight: loosen the gland bolt nuts.
- Coupling type "A": tight fit between bush and stem: increase the thread clearance on the drive coupling.
- Coupling types "B1", "B2", "B3" and "B4": ensure there are no axial forces on the valve stem by leaving an adequate axial clearance between the stem and the drive bush. Also check that all transmission shafts, universal joints or bulkhead passages have sufficient lubrication and check that the transmission shafts are not bent.
- Check that the internal valve trim or the reducer gears are well lubricated and not damaged.
- Check the alphanumeric display for diagnostic messages, and proceed with the suitable corrective actions as described in this chapter, paragraph 12.11, Diagnostic messages.

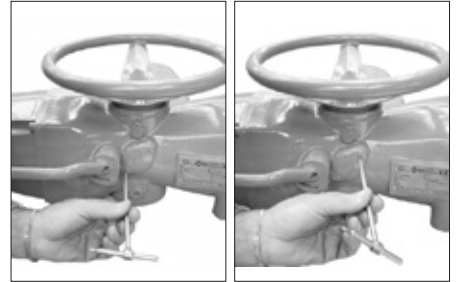

12.9 THE ACTUATOR DOES NOT STOP IN FULLY OPEN OR FULLY CLOSED POSITION

- Check that the actual open and close positions of the valve respectively correspond to 100% and 0% on the actuator display
- Make sure that the torque and travel limits are correctly set (see paragraph 9.1, Set-up routines - Actuator set-up).

12.10 THE NUMERIC POSITION DISPLAY INDICATES "E01"

- It is necessary to re-calibrate the stroke limits (see paragraph 9.1, Set-up routines - Actuator set-up).

12.11 DIAGNOSTIC MESSAGES

The alarm and warning lists contain the alarms and warnings momentarily present.

Warning is the condition that occurs when a variable reaches a critical value and/or when a maintenance action is required but all actuator functions are still available. The flashing of the alarm/warning LED indicates a warning condition.

Alarm is the condition that occurs when a variable is outside the acceptable range and some actuator function is not available. If the alarm/warning LED is on there is an alarm condition.

When the fault condition disappears, the corresponding alarm or warning also disappears from the list.

A reset routine is provided to clear the types of alarms and warnings that are memorized (over-torque, jammed valve, etc.).

View procedure

- Move the 3-position selector to either OFF or REMOTE, then press NO to scroll the list of available variables.
- Press YES when the display shows message "ALARMS view?" Press YES to scroll the list of alarms.
- Press NO when the display shows message "ALARMS view?".
- Press YES when the display shows message "WARNINGS view?" Press YES to scroll the list of warnings.
- Press YES to reset the alarms or warnings with memory.

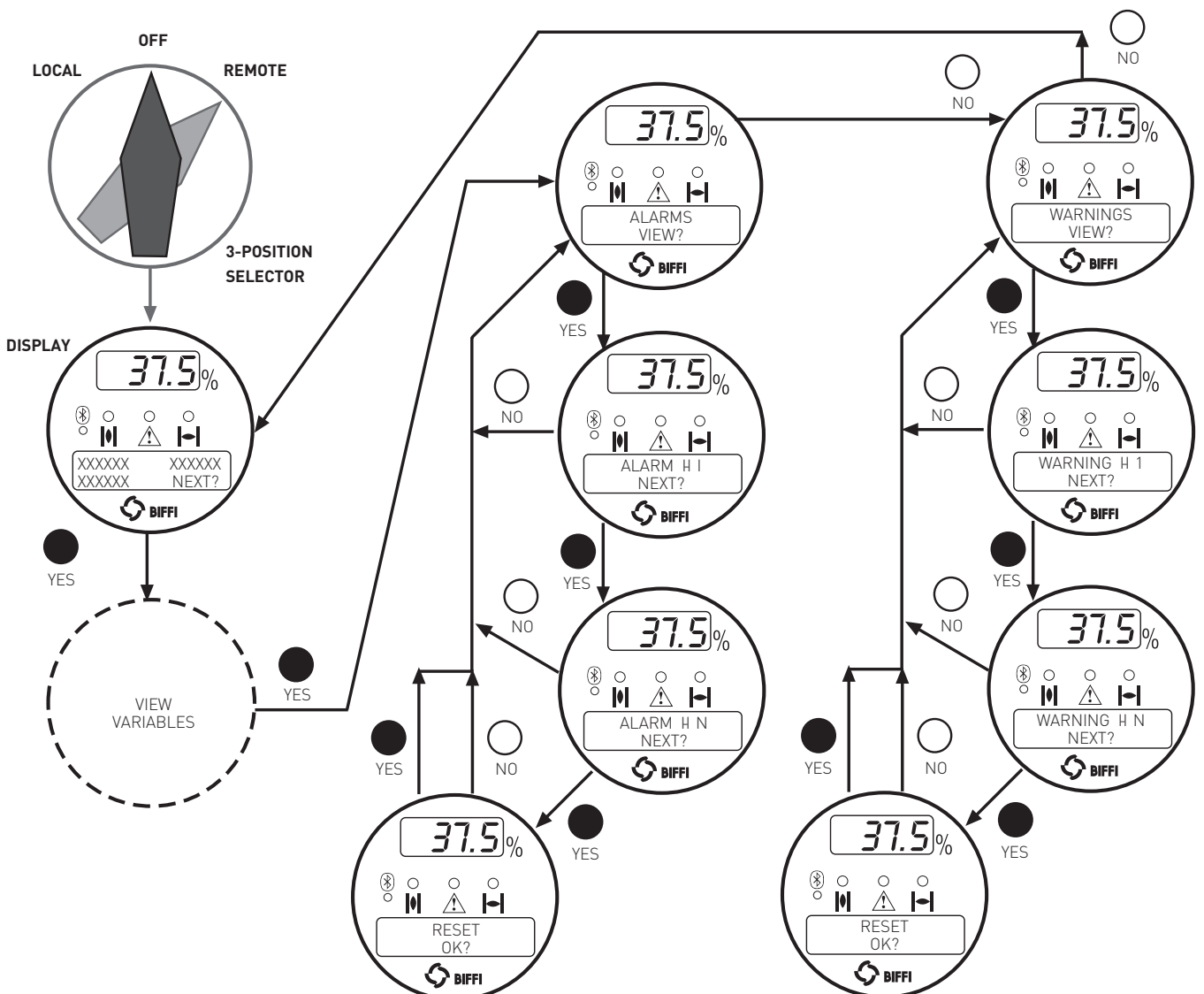

ALARM TABLE

| Display message | Condition for alarm | Action | Available controls | | | Alarm reset |
|---|---|--|-----------------------------|-----------------------------------|---------------------------------------|-------------------------------------|
| | | | Local | Remote | ESD | |
| High torque in closing | Measured torque greater than the relevant value configured in torque set-up or stroke limits routine | Operate the actuator in opening direction. Check the torque needed to operate the valve | Only open | Only open | Configuration dependent | Open control |
| High torque in opening | Measured torque greater than the relevant value configured in torque set-up or stroke limits routine | Operate the actuator in closing direction. Check the torque needed to operate the valve | Only close | Only close | Configuration dependent | Close control |
| Jammed valve in closing | No position change after receiving a CLOSE control | Check status of actuator and valve mechanical parts | Only open | Only open | Only open | Open control |
| Jammed valve in opening | No position change after receiving an OPEN control | Check status of actuator and valve mechanical parts | Only close | Only close | Only close | Close control |
| Motor thermostat | Motor thermostat open for high temperature in the motor windings | Wait until the motor cools down | Not available | Not available | Configuration dependent | When thermostat closes |
| Internal-temperature | Temperature inside the actuator enclosure higher than 90°C or lower than -40°C | Ambient temperature too high or too low. Verify insulation among actuator and heat source | Not available | Not available | Not available | Control temperature <90°C or >-40°C |
| Position sensor | Value of the actuator position not valid | Replace position sensor or re-calibrate both stroke limits | Not available | Not available | Not available | Position signal correct |
| Speed sensor | Measure of motor speed not valid | Replace speed sensor | Not available | Not available | Not available | Speed signal correct |
| Mid travel alarm in OP | The valve does not move in presence of an open control | Check status of actuator and valve mechanical parts. Recalibrate both stroke limits | Only close | Only close | Only close | Close control |
| Mid travel alarm in CL | The valve does not move in presence of a close control | Check status of actuator and valve mechanical parts. Recalibrate both stroke limits | Only open | Only open | Only open | Open control |
| Main voltage | Main voltage lower than -20% or higher than +20% of the value stated in the name plate menu | Check main voltage supply and frequency on terminals L1, L2, L3. Check that wires section is correct | Not available | Not available | Not available | Main voltage correct |
| K1 contactor (not available for ICON LP) | The test routine reports a failure of K1 (coil or auxiliary contact) | Check the contactor | Opposite direction | Opposite direction | Not available if ESD use K1 contactor | Control in opposite direction |
| K2 contactor (not available for ICON LP) | The test routine reports a failure of K2 (coil or auxiliary contact) | Check the contactor | Opposite direction | Opposite direction | Not available if ESD use K2 contactor | Control in opposite direction |
| Configuration obj n° | The checksum of the EEPROM memory that contains the configuration data is wrong | Re-configure all parameters (see details next page) | Not available | Not available | Not available | Memory OK |
| Hardware n° | The diagnostic program detects some malfunction in the electronics controlling the actuator | Some circuit is damaged and does not work (see details next page) | Not available | Not available | Not available | Hardware OK |
| Low lithium battery | The voltage of the lithium battery is too low (only detected if the lithium battery is present and the relevant parameter of the miscellaneous routine is set to "present") | Change lithium battery | Available with main voltage | Available with main voltage | Available with main voltage | Lithium battery OK |
| Lost phase LP Configuration (not available for ICON LP) | The alarm appears only with 3-phase main supply. The alarm is generated in case of fault of one of the phases that supply the actuator transformer | Check main power supply on terminals L1, L2, L3 | Not available | Not available | Not available | Phase OK |
| Request signal | The analog 4-20 mA signal is not correct | Check the external 4-20 mA generator and wiring | Available | Positioner function not available | Available | 4-20 mA input OK |
| LP Configuration (for ICON LP only) | ICON LP Configuration is not correct | Check the parameters setting | Available | Available | Available | Correct the wrong parameters |
| Driver Fault (for ICON LP only) | Power Card Failure | Check the Power Card | Available | Available | Available | Power Card works properly |
| Direction (for ICON LP only) | Motor rotates in the wrong direction | Check the motor wiring | Available | Available | Available | Correct the motor wiring and reset |

WARNING TABLE

| Display message | Condition for warning | Action | Available controls | | | Warning |
|---|---|--|--------------------|-----------|-----------|--------------------------------------|
| | | | Local | Remote | ESD | |
| High torque in OP (near max.) | Measured torque 10% lower than the relevant value configured in torque set-up or stroke limits routines | Check the torque necessary to move the valve | Available | Available | Available | Close control |
| High torque in CL (near max.) | Measured torque 10% lower than the relevant value configured in torque set-up or stroke limits routines | Check the torque necessary to move the valve | Available | Available | Available | Open control |
| Internal temp (near limits) | Temperature inside the actuator enclosure higher than 80°C or lower than -35°C | Find the heat source and insulate the actuator | Available | Available | Available | Control temperature >-35°C and <80°C |
| Main voltage (near limits) | Value of the main voltage out of the correct range (-15% or +10% of the value stated in the name plate menu) or wrong frequency | Check section of wires and values of voltage and frequency | Available | Available | Available | Main voltage correct |
| (Max.) contactor cycles (not available for ICON LP) | Max. number of contactor cycles reached | Change contactor and reset operation log | Available | Available | Available | Clear recent data log |
| Maintenance request | Date of the next maintenance reached | Perform maintenance and set next maintenance date | Available | Available | Available | Change date |
| Motor current | Motor current greater or lower than limits | Check electrical motor | Available | Available | Available | Current OK |
| Wrong stroke limits | The routine that monitors the stroke limits detects a wrong end of travel condition | Re-calibrate both stroke limits | Available | Available | Available | Re-calibrate both stroke limits |
| Bus | Fieldbus not working | Check bus communication | Available | Available | Available | Bus OK |
| Low speed (for ICON LP only) | Set speed not reached | Check the mechanics or the parameters setting | Available | Available | Available | Reset or redo Open/ Close Control |

Configuration obj n°

N° indicates the number of the parameter to be configured. To clear the alarm the table of all ICON 2000 parameters is necessary. Call Biffi After-sales service to solve the problem. If the alarm message is "CONFIGURATION OBJ 9999" only one of the ICON 2000 parameters needs to be changed. For instance: enter the SET-UP menu, actuator set-up, torque set-up, and either increase or decrease the closing torque by 1%. As the alarm message disappears re-enter the SET-UP menu, actuator set-up, torque set-up, and set the previous value (see paragraph 9.1, Actuator set-up, Torque set-up).

Hardware n°

N° indicates the module that is not working. The problem may be due to a malfunction of the module, to an incorrect wiring between modules, or to an incorrect setting of the ICON 2000. Call Biffi After-sales service to solve the problem. The following hardware alarms can be detected:

- Hardware 1 = incorrect coding of local push-buttons and selector.
- Hardware 2 = incorrect configuration of Ain/Aout optional module
- Hardware 3 = no communication between Ain/Aout optional module and base card
- Hardware 4 = incorrect configuration of type of terminal board
- Hardware 5 = no communication between terminal board and base card
- Hardware 6 = incorrect configuration ICON 2000 / F01-2000
- Hardware 7 = incorrect configuration of type of bus card
- Hardware 8 = no communication between bus card and base card
- Hardware 9 = Logic Card cannot update the settings of the Power Card (for ICON LP only)
- Hardware 10 = Logic Card cannot communicate with the Power Card (for ICON LP only)

13 PARTS LIST AND DRAWINGS

13.1 INTRODUCTION

This chapter includes the drawings and parts list of each component and subassembly of ICON 2000 actuators.

IMPORTANT

- *When ordering spare parts, please indicate the serial number embossed on the actuator nameplate.*
- *When ordering spare parts, please refer to the item number on the attached drawings.*

COMPONENT PARTS

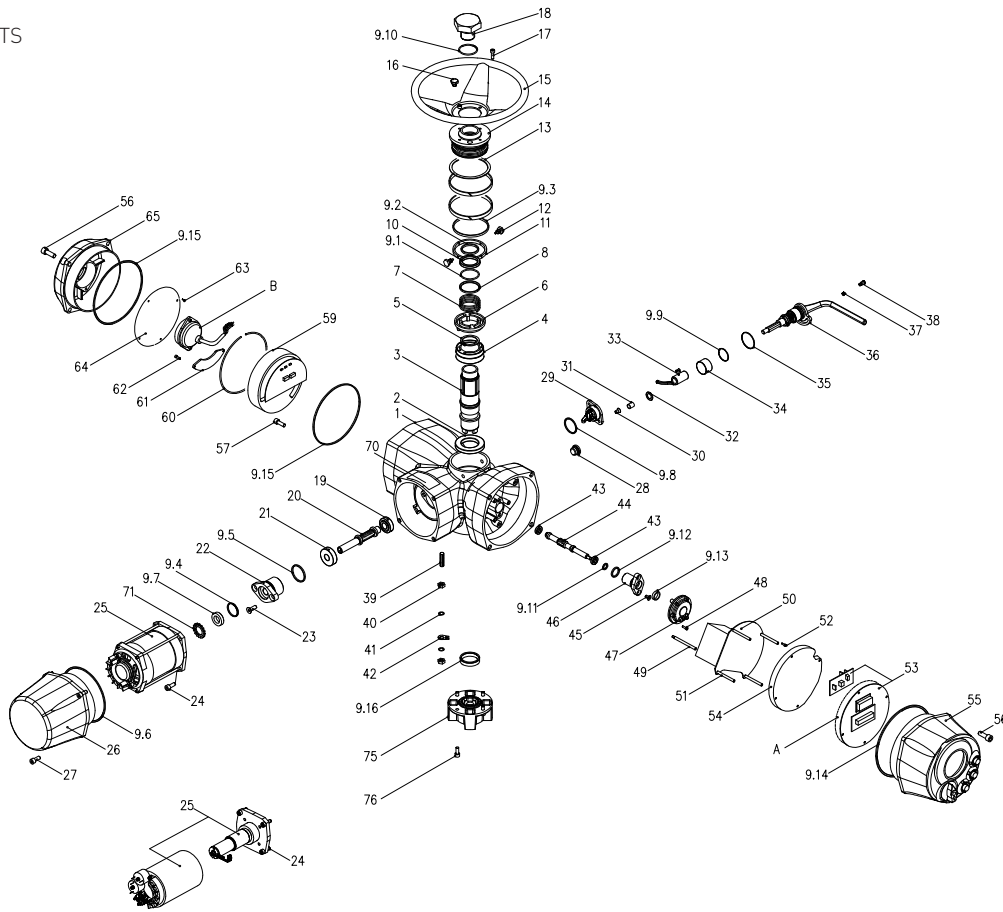

TABLE 1 - COMPONENT PARTS

| Item | Qty | Description | Item | Qty | Description | Item | Qty | Description |
|--------|-----|-----------------------|------|-----|-----------------------------|----------|-----|--------------------------|
| 1 | 1 | Housing | 15 | 1 | Handwheel | 45 | 2 | Screw |
| 2 | 1 | Lower bearing | 16 | 1 | Oil plug | 46 | 1 | Position sensor flange |
| 3 | 1 | Hollow shaft | 17 | 4 | Screw | 47 * | 1 | Position sensor assembly |
| 4 | 1 | Worm wheel | 18 | 1 | Stem protection tube | 48 | 3 | Screw |
| 5 | 1 | Circlip | 19 | 1 | Taper bearing | 49 | 4 | Column |
| 6 | 1 | Driver sleeve | 20 | 1 | Worm shaft | 50 * | 1 | Power card |
| 7 | 1 | Driver sleeve spring | 21 | 1 | Taper bearing | 51 | 4 | Column |
| 8 | 1 | Spring retaining ring | 22 | 1 | Worm shaft flange | 52 | 4 | Screw |
| 9 * | 1 | Seal kit | 23 | 2 | Screw | 53 * | 1 | Processor card |
| 9.1 * | 1 | O-ring | 24 | 4 | Screw | 54 | 1 | Power card cover |
| 9.2 * | 1 | Seal ring | 25 * | 1 | Electric motor assembly | 55 | 1 | Local interface assembly |
| 9.3 * | 1 | Q-ring | 26 | 1 | Motor cover | 56 | 8 | Screw |
| 9.4 * | 1 | O-ring | 27 | 4 | Screw | 57 | 1 | Screw |
| 9.5 * | 1 | O-ring | 28 | 1 | Oil plug | 59 * | 1 | Terminal board |
| 9.6 * | 1 | O-ring | 29 * | 1 | Finger assembly | 60 | 1 | Circlip |
| 9.7 * | 1 | Seal ring | 30 | 2 | Screw | 61 | 1 | Power terminals cover |
| 9.8 * | 1 | O-ring | 31 | 1 | Bush | 62 | 2 | Screw |
| 9.9 * | 1 | O-ring | 32 | 1 | Shoulder washer | 63 | 4 | Screw |
| 9.10 * | 1 | O-ring | 33 | 1 | Fork | 64 | 1 | Terminal board plate |
| 9.11 * | 1 | Q-ring | 34 | 1 | Bearing bush | 65 | 1 | Terminal board cover |
| 9.12 * | 1 | O-ring | 35 | 1 | Lever washer | 70 | 1 | Data plate |
| 9.13 * | 1 | Seal ring | 36 | 1 | Lever assembly | 71 | 1 | Circlip |
| 9.14 * | 1 | O-ring | 37 | 1 | Lever screw block | 75 | 1 | Thrust block assembly |
| 9.15 * | 2 | O-ring | 38 | 1 | Screw | 76 | 4 | Screw |
| 9.16 * | 1 | Seal ring | 39 | 1 | Earth stud | | | |
| 10 | 1 | Upper bearing | 40 | 2 | Earth stud nut | Optional | | |
| 11 | 2 | Cover retaining ring | 41 | 2 | Washer | A * | 1 | Bus interface card |
| 12 | 2 | Plug | 42 | 1 | Earth stud indication plate | B | 1 | Battery assembly |
| 13 | 1 | Cover shoulder washer | 43 | 2 | Bearing | | | |
| 14 | 1 | Cover | 44 | 1 | Position sensor shaft | | | |

* Recommended spare parts

ELECTRIC MOTOR

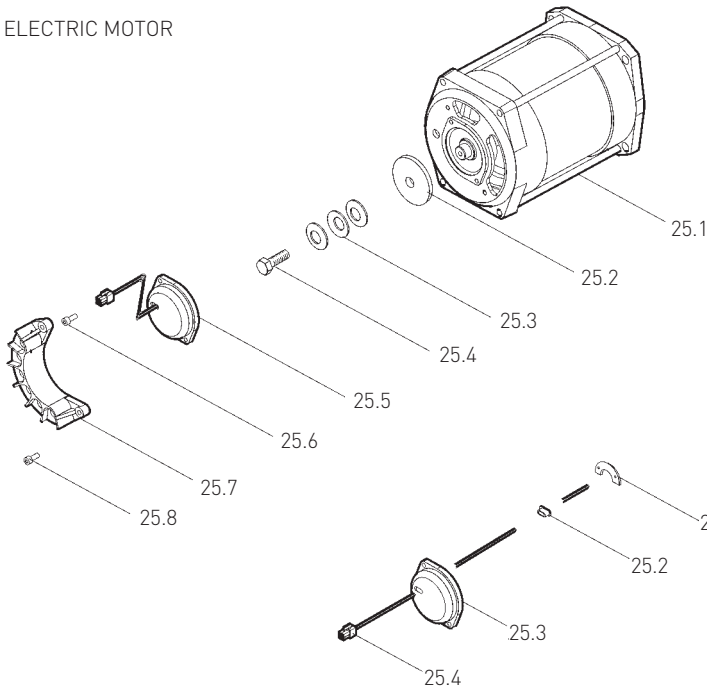

TABLE 2 - ELECTRIC MOTOR

| Item | Qty | Description |
|-------------------------------------|-----|------------------------------|
| 25.1 * | 1 | Electric motor |
| 25.2 | 1 | Speed magnetic sensor |
| 25.3 | 3 | Spring |
| 25.4 | 1 | Screw |
| 25.5 * | 1 | Speed magnetic card assembly |
| 25.6 | 2 | Screw |
| 25.7 | 1 | Motor terminals board |
| 25.8 | 1 | Screw |
| Speed magnetic card assembly | | |
| 25.5.1 | 1 | Speed magnetic card |
| 25.5.2 | 1 | Rubber ring |
| 25.5.3 | 1 | Speed sensor cover |
| 25.5.4 | 1 | Speed sensor cable |

* Recommended spare parts

ELECTRIC MOTOR (ICON LP)

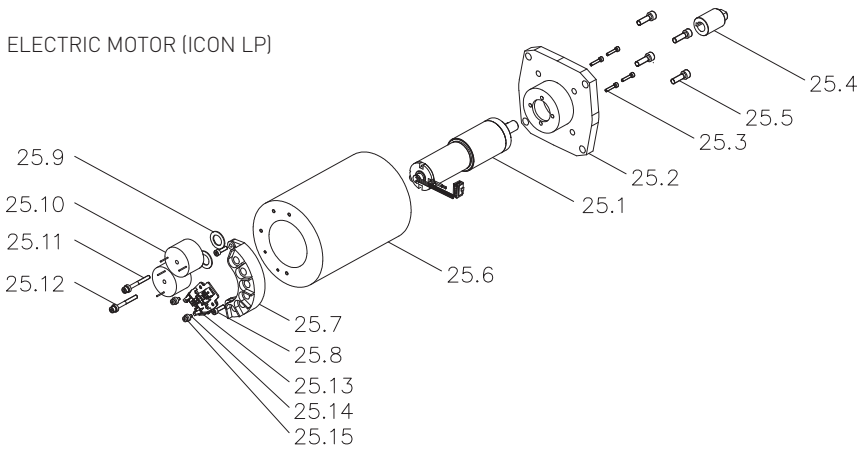

TABLE 3 - ELECTRIC MOTOR (ICON LP)

| Item | Qty | Description | Material |
|---------|-----|-----------------------|----------------|
| 25.1 * | 1 | Electric motor | - |
| 25.2 | 1 | Flange | Carbon steel |
| 25.3 | 4 | Screw | Sainless steel |
| 25.4 | 1 | Motor coupling | Carbon steel |
| 25.5 | 4 | Screw | Sainless steel |
| 25.6 | 1 | Bracket | Alluminum |
| 25.7 | 1 | Motor terminals board | Plastic |
| 25.8 | 2 | Screw | Sainless steel |
| 25.9 | 2 | Washer | Plastic |
| 25.10 * | 2 | Inductance coil | - |
| 25.11 | 2 | Screw | Sainless steel |
| 25.12 | 2 | Washer | Plastic |
| 25.13 * | 1 | Electronic card | - |
| 25.14 | 2 | Screw | Sainless steel |
| 25.15 | 2 | Washer | Plastic |

* Recommended spare parts

FINGER ASSEMBLY

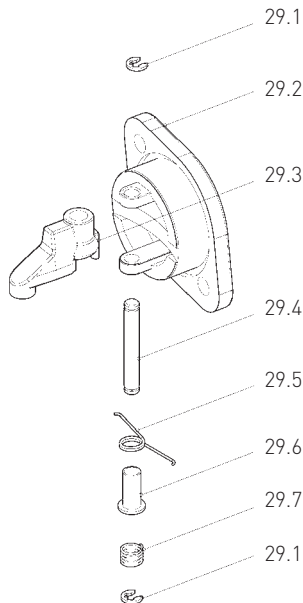

TABLE 4 - FINGER ASSEMBLY

| Item | Qty | Description |
|------|-----|----------------|
| 29.1 | 2 | Circlip |
| 29.2 | 1 | Cover finger |
| 29.3 | 1 | Finger |
| 29.4 | 1 | Pin |
| 29.5 | 1 | Bending spring |
| 29.6 | 1 | Bush |
| 29.7 | 1 | Spring |

LEVER ASSEMBLY

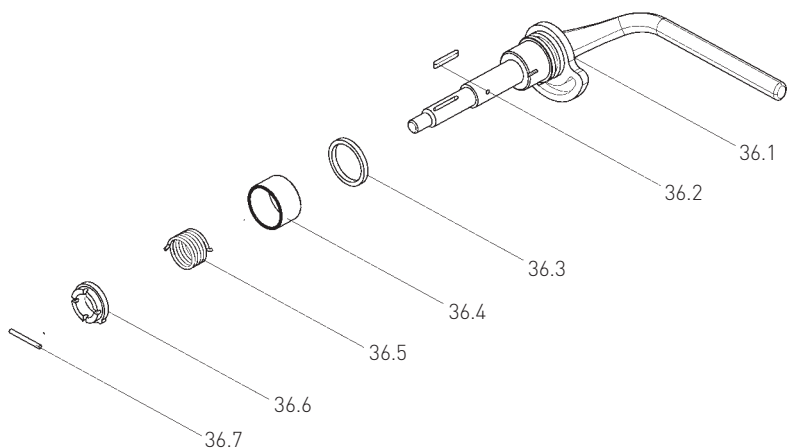

TABLE 5 - LEVER ASSEMBLY

| Item | Qty | Description |
|------|-----|-----------------|
| 36.1 | 1 | Lever |
| 36.2 | 1 | Key |
| 36.3 | 1 | Shoulder washer |
| 36.4 | 1 | Bearing |
| 36.5 | 1 | Spring |
| 36.6 | 1 | Retainer ring |
| 36.7 | 1 | Pin |

POSITION SENSOR ASSEMBLY

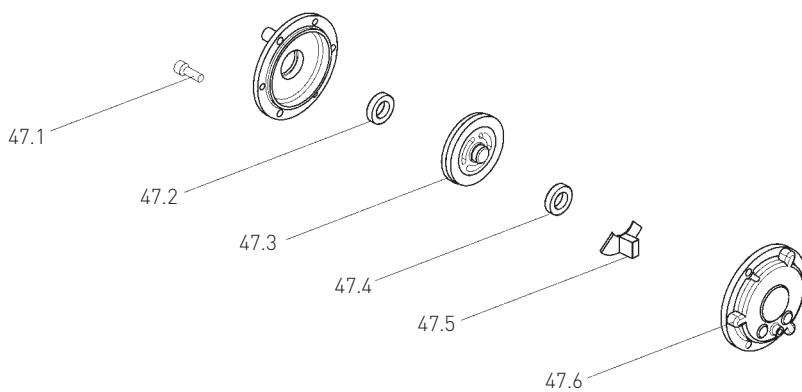

TABLE 6 - POSITION SENSOR ASSEMBLY

| Item | Qty | Description |
|------|-----|---------------|
| 47.1 | 2 | Screw |
| 47.2 | 1 | Cover |
| 47.3 | 2 | Bearing |
| 47.4 | 1 | Magnetic disk |
| 47.5 | 1 | Sensor card |
| 47.6 | 1 | Base |

LOCAL INTERFACE ASSEMBLY

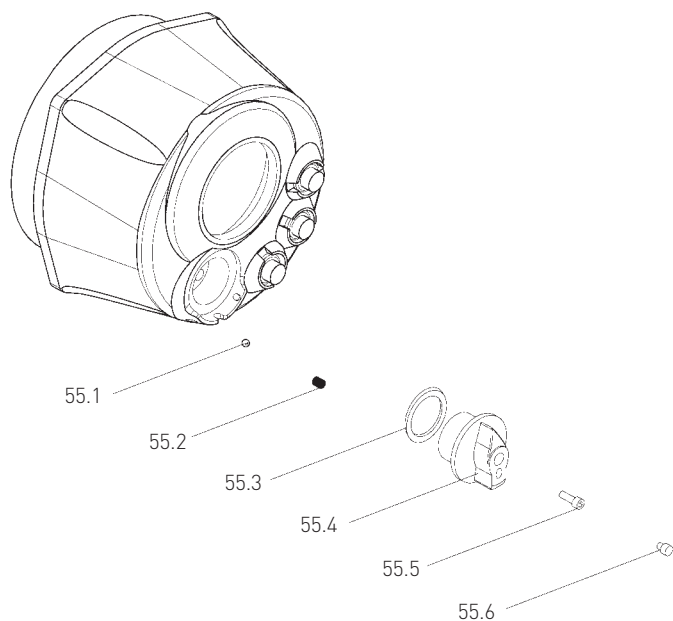

TABLE 7 - LOCAL INTERFACE ASSEMBLY

| Item | Qty | Description |
|--------|-----|-------------|
| 55.1 * | 1 | Ball |
| 55.2 * | 1 | Spring |
| 55.3 * | 1 | O-ring |
| 55.4 * | 1 | Selector |
| 55.5 * | 1 | Screw |
| 55.6 * | 1 | Plug |

* Recommended spare parts

THRUST BLOCK ASSEMBLY

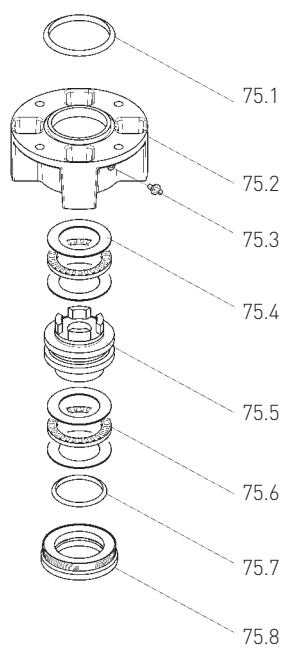

TABLE 8 - THRUST BLOCK ASSEMBLY

| Item | Qty | Description |
|--------|-----|----------------------|
| 75.1 | 1 | O-ring |
| 75.2 | 1 | Thrust block housing |
| 75.3 * | 1 | Greaser |
| 75.4 | 4 | Thrust washer |
| 75.5 | 1 | Stem nut |
| 75.6 * | 2 | Thrust bearing |
| 75.7 * | 1 | Quad ring |
| 75.8 | 1 | Lower ring nut |

* Recommended spare parts

WIRING LOOM AND CABLES IDENTIFICATION

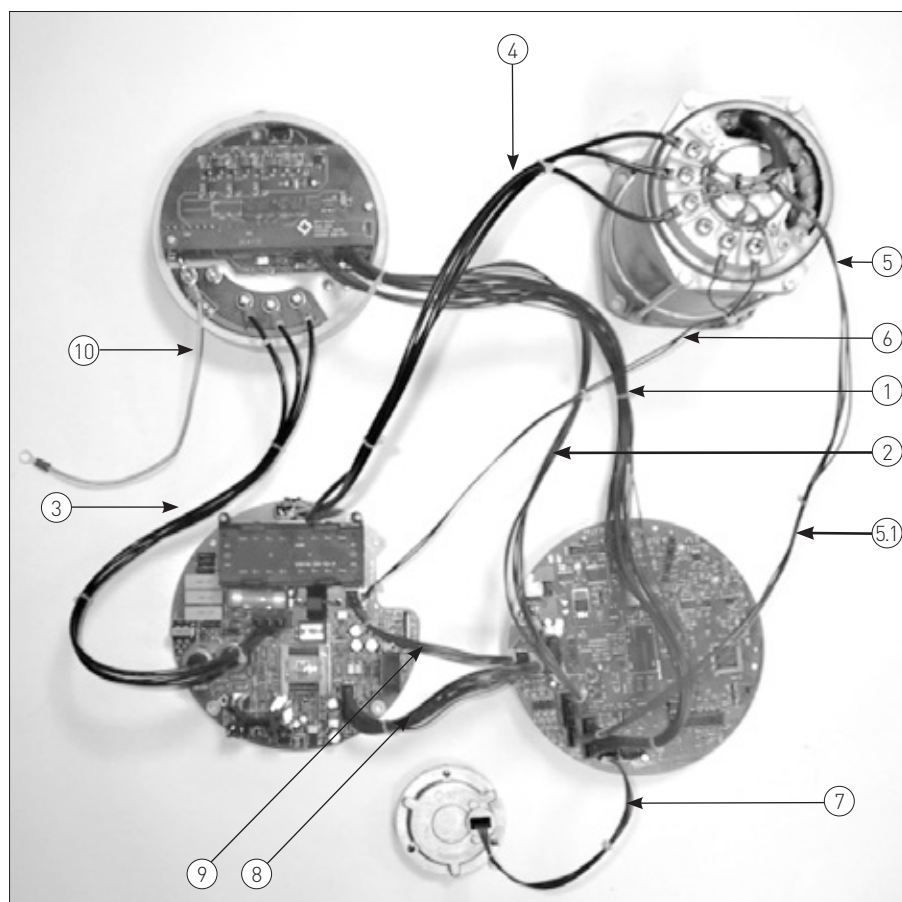

TABLE 9 - WIRING LOOM AND CABLES IDENTIFICATION

| Item | Cable type | Description |
|------|------------|-----------------------------|
| 1 | CAB0100 | I/O remote cable |
| 2 | CAB0150 | Remote control supply cable |
| 3 | CAB0160 | Inlet power cable |
| 4 | CAB0270 | Motor power cable |
| 5 | CAB0350 | Speed sensor cable |
| 5.1 | CAB0354 | Speed sensor cable |
| 6 | CAB0280 | Thermostat cable |
| 7 | CAB0300 | Position sensor cable |
| 8 | CAB0200 | Internal controls cable |
| 9 | CAB0250 | Contact controls cable |
| 10 | CAB0170 | Earth wire |

14 SAFETY INSTRUCTIONS

14.1 GENERAL

This Addendum A is an integration to ICON 2000 main IOM VCIOM-01232 to prescribe the safety instructions applicable to all the electric actuators Series ICON 2000 / ICON 2000 AD either as a base unit either when they are equipped with an optional extension [A] for additional entry mounted on the control compartment or when they are equipped with an optional extension [B] with additional entries or with an optional extension [C] with optional electronic card both mounted on the terminal board compartment, as identified by the pictures here below, when they are installed in Hazardous Areas as defined by the IEC/EN 60079-10-1 IEC/EN 60079-10-2. Under the same conditions, the optional extensions [A], [B] or [C], can be mounted on a base unit ICON 2000 / ICON 2000 AD already installed on field.

WARNING

It is assumed that the installation, setting, commissioning, maintenance and repair works are carried out by qualified personnel and checked by responsible specialists.

Both the base unit ICON 2000 / ICON 2000 AD and optional extension are designed in accordance with the applicable international rules and specifications but in any case the following regulation must be observed:

- The general installation and safety regulations.
- The proper use of personal protective devices (glasses, clothing, gloves).
- The proper use of tools, lifting and transport equipment.

14.2 IDENTIFICATION OF MAIN PARTS



Base unit



Base unit with extension [A]

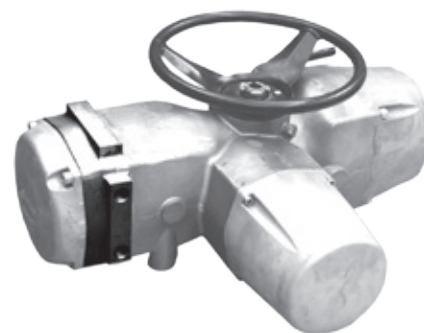

Base unit with extensions [B] or [C]

15 CHECK FOR RIGHT APPLICATION

WARNING

Before the installation it is mandatory to check if the nameplate associated to the extension for additional entry specifies the appropriate degree of protection and ambient temperature limits as requested by the rules applicable to the plant/ location where units are installed. Template of the label is attached here below.

Installation in ambient with the presence of explosive atmosphere not covered by the specified grade of protection, or which could reach temperature higher than the maximum specified on the label, will invalidate the safety and the warranty.

15.1 MARKING

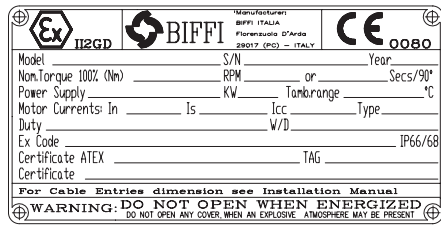

Template of the label for ICON 2000 / ICON 2000 AD

| | |
|-------------------|--|
| IECEX INE XX.ZZZZ | IECEX reference certificate (CoC) |
| XX ATEX ZZZZ | ATEX reference certificate |
| 0080 | Notified body for ATEX quality assurance (INERIS) |
| II | Group II (surface industries) |
| 2 | Category 2 apparatus |
| G | Explosive atmospheres caused by gas, mists or vapors |
| D | Explosive atmospheres caused by gas dusts |
| IP66/68 | Degree of protection |

| Hazardous zone | Zone | Categories according to 94/9/EC Directive |
|----------------------|------|---|
| Gas, mist or vapors | 0 | 1G |
| Gas, mists or vapors | 1 | 2G or 1G |
| Gas, mists or vapors | 2 | 3G or 2G or 1G |
| Dust | 20 | 1D |
| Dust | 21 | 2D or 1D |
| Dust | 22 | 3D or 2D or 1D |

EQUIPMENT PROTECTION LEVEL (EPL) EN 60079-14

| Explosive atmosphere | Zone | EPL |
|----------------------|------|----------------|
| Gas | 0 | Ga |
| Gas | 1 | Ga or Gb |
| Gas | 2 | Ga or Gb or Gc |
| Dust | 20 | Da |
| Dust | 21 | Da or Db |
| Dust | 22 | Da or Db or Dc |

16 APPLICABLE GENERAL STANDARDS AND REGULATIONS

| | |
|-------------------|--|
| 2006/42/EC | Machinery Directive |
| 2004/108/EC | EMC Directive |
| 2006/95/EC | Low Voltage Directive |
| 94/9/EC | ATEX Directive |
| EN ISO 12100-1 | Safety of machinery - Basic concepts, general principles for design. Part 1-Basic terminology, methodology |
| EN ISO 12100-2 | Safety of machinery - Basic concepts, general principles for design. Part 2-Technical principles and specification |
| EN 60079-0: 2009 | IEC 60079-0: 2011 |
| EN 60079-1: 2007 | IEC 60079-1: 2007 |
| EN 60079-7: 2007 | IEC 60079-7: 2006 |
| EN 60079-11: 2012 | IEC 60079-11: 2011 |
| EN 60079-31: 2009 | IEC 60079-31: 2008 |
| EN 13463-1: 2009 | |
| EN 13463-5: 2003 | |

17 TERMS AND CONDITIONS

Biffi guarantees each single product to be free from defects and to conform to current goods specifications. The warranty period is one year from the date of installation by the first user, or eighteen months from the date of shipment to the first user, whichever occurs first. No warranty is given for products or components manufactured by third-party companies, or for goods which have been subject to misuse, improper installation, corrosion, or which have been modified or repaired by unauthorized personnel. Repair work due to improper use will be charged at standard rates.

18 MANUFACTURER'S LIABILITY

- Biffi Italia declines all liability in the event of:
- Use of product in contravention of local safety at work legislation.
 - Incorrect installation, disregard or incorrect application of the instructions provided on the product nameplate and in VCIOM-01232 main Instruction and Operating Manual and relevant Addendum A.
 - Modification of the product without Biffi's authorization.
 - Work done on the product by unqualified or unsuitable personnel.

19 STORAGE AND PRE-INSTALLATION

19.1 STORAGE PROCEDURE

IMPORTANT

Not performing the following procedures will invalidate the product guarantee.

Normally the optional extension for additional entry/entries or additional electronic card are directly mounted on the base ICON 2000 / ICON 2000 AD by Biffi and leaves the factory in perfect condition. Under this condition the general storage procedure as stated in VCIOM-01232 main Instruction and Operating Manual must be applied.

When the above extensions are shipped separately for a field upgrading on existing ICON 2000 / ICON 2000 AD unit this must be stored in a protected area taking care that the explosion proof joints are well protected avoiding any damage to the joint surfaces. The standard plastic plugs used to protect the cable entry during the transport is not explosion proof nor water proof, it just prevent the entry of undesired objects during transport. The extension for additional entry/entries or additional electronic card maintain the same weatherproof degree of protection as the base ICON 2000 / ICON 2000 AD. This condition can only be maintained if the extension is correctly installed/connected on site and if it has been correctly stored.

19.2 CHECKS TO BE PERFORMED BEFORE INSTALLATION

Before to install the extension for additional entry/entries or additional electronic card in an existing unit ICON 2000 / ICON 2000 AD the following checks are recommended:

- The status of the joint surfaces.
- Status of the threads on the conduit entry.
- Whether the enclosure holding the additional conduit entry is cracked or broken.

20 INSTALLATION

IMPORTANT

The installation must be carried out in accordance to the applicable standards IEC/EN 60079-14 and IEC/EN 60079-17 regarding the electrical installations in Hazardous Areas (other than mines) classified as Zones 1, 2 (gas) and Zones 21, 22 (dust) following IEC/EN 60079-10-1 and IEC/EN 60079-10-2 and any other applicable national standards and rules.

20.1 WORKING CONDITION

WARNING

For the correct utilization with respect to the safety and the functionality of the enclosures components, check the "temperature ambient range" embossed on the nameplate.

20.1.1 Models and temperature

ICON-040 and ICON-050:

- from -25°C to +60°C (from -13°F to +140°F)

20.1.2 Base unit with extensions [A] or [B] or [C]

When on the foreseen extension is installed in an ICON 2000 / ICON 2000 AD unit the whole assembly is suitable for the following ambient temperatures:

- from -25°C to +60°C (from -13°F to +140°F)
 for all models the maximum permissible temperature is depending from the type of motor (SM or TM) installed on the base ICON 2000 / ICON 2000 AD unit.

20.2 IDENTIFICATION OF ENTRY

20.2.1 Base actuator

Electric actuators Series ICON 2000 / ICON 2000 AD are equipped with 4 entries (3 are standard, the fourth is supplied when requested).

With reference to the attached picture, the thread form/size for each entry is as follows:

| Entry | NPT size | Alternative |
|--------------|----------|-----------------------|
| | | (Metric size ISO 965) |
| 1 | 1" | M32x1.5 |
| 2 | 1-1/2" | M40x1.5 |
| 3 | 1" | M32x1.5 |
| 4 (optional) | 3/4" | M25x1.5 |

IMPORTANT

When alternative entries are used, indication of the dimensions is imprinted directly on the housing close to the entry.

WARNING

Unused entries may remain unmachined or must be plugged with a certified plug suitable for the area.

20.2.2 Base actuator with extension [A] on the control compartment

The extension [A] provides an additional entry for cable or conduit connection or for a connection of an external ATEX certified apparatus.

With reference to the attached picture, the thread form/size for the entry is as follows:

| Entry | Standard size | Optional |
|-------|---------------|----------|
| | | |
| 5 | M25x1.5 | N/A |

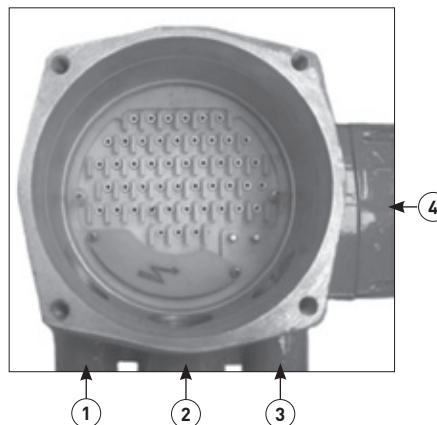

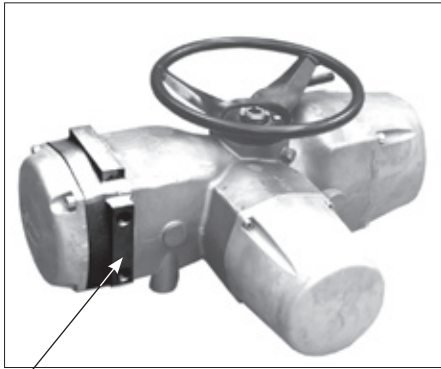

Entries from A to K



Internal earth stud



External earth stud

20.2.3 Base actuator with extensions [B] or [C] on the terminal board compartment

The extensions [B] or [C] provide up to 9 additional entries for cable or conduit connection. With reference to the attached picture, the thread form/size for the entries is as follows:

| Entries | Option 1 Standard entries | Option 2 Alternative entries (ISO 965) |
|------------------------------|---------------------------------|--|
| A, B, C, D, E, F, G, H, K | 1/2" NPT | M20x1.5 |

IMPORTANT

When alternative entries are used, indication of the dimensions is imprinted directly on the housing close to the entry.

WARNING

Unused entries may remain unmachined or must be plugged with a certified plug suitable for the area.

20.3 WIRING

The external wires or the connections of the external ATEX certified apparatus through the conduit entry of the additional extension, must be wired to the internal cards of the ICON 2000 / ICON 2000 AD in accordance to the wiring diagram and to the general instructions attached to the documentation of the base unit.

20.4 CABLE CONNECTION

When optional extension for additional entry/ entries or additional electronic card are used to connect external cables or conduits, the sealing of cables/conduits entries must be carried out in accordance with national standards or the regulatory authorities that have certified the extension with additional conduit entry. Method of sealing and cable glands must be approved and separately certified for use in hazardous areas.

Two earth points of connection, one internal and one external, are foreseen on the base ICON 2000 / ICON 2000 AD units enclosure for the ground cables connection.

IMPORTANT

To prevent any water infiltration through the line cable conduits, be sure the cable glands used have the minimum degree of protection required by the plant.

To guarantee that the weatherproof and explosion-proof characteristics are respected, screw the cable gland or the external ATEX certified apparatus tightly (at least 5 turns) and block them with a thread sealant.

IMPORTANT

The cables and cable glands MUST be selected considering the maximum temperature of the cable indicated on the label fixed to the base ICON 2000 unit.

20.5 INSTALLATION IN AMBIENT WITH EXPLOSIVE DUSTS

Special attention must do to these following points:

- Before the assembly the joint surfaces must be greased with Aeroshell grease.
- The cable glands must have a protection degree at minimum IP66 or IP68 (15 m depth / 90 hours) according to IEC/EN 60529 standard.
- Periodically verify the quantity of dust deposited on the enclosure and clean it in the case the quantity becoming more than 5 mm.

21 MAINTENANCE

WARNING

In case the units equipped with extension for additional entry or additional entries, already installed in HAZARDOUS AREAS, need maintenance and/or any repair work, this must be carried out by personnel specifically qualified and fully trained for works in HAZARDOUS AREAS.

21.1 PERIODIC INSPECTIONS

- Inspect the general conditions of the ICON 2000 / ICON 2000 AD plus the possible optional additional extension at regular intervals: recommended frequency of inspection is one time every two years but this frequency could be changed depending on the installation and working conditions: any crack on the surface, broken window or loose bolts must be reported for repair.
- Keep the external surfaces of the unit clean: if the unit is installed in a dusty environment the specification stated in IEC/EN 60079-14 to be followed ensuring in particular that the dust layer does not exceed 5 mm.
- Check the condition of cable connection and mounting bolts: any loose connection must be amended.

21.2 DISMANTLING AND REASSEMBLING

WARNING

In case the screws of the cover must be replaced, a SS AISI 316 Class A4 Grade 70, must be used with minimum yield strength of 450 N/mm².

In case a dismantling and subsequent reassembling of the explosion-proof enclosure is required, be careful to maintain all parts in their original condition.

So the following procedure must be followed:

- Do not damage the explosion-proof mating surfaces on the housing and on the electrical enclosure cover.

- Reinstall all the screws that go with the dismantled parts and block after spreading them with a film of molybdenum-based grease. This will keep screws from sticking and make maintenance future operations easier.
- In case the screws need to be changed it is mandatory to assure that the new screws are of the same dimension and same material as the original ones as stated in this manual, or of a better quality.
- Replace the weatherproof seals that may have been removed i.e: O-rings for the cover.
- In particular, be sure the joint surfaces of all enclosures are spread with a film of Aeroshell grease.

21.3 REPAIRS

When needed, repair must only be carried out with manufacturer's original spare parts.

WARNING

The values of gaps of explosion-proof joints are lower than the maximum specified on tables of IEC/EN 60079-1 Standard and the values of widths of the explosion-proof joints are superior to the values specified on tables of the Standard IEC/EN 60079-1. In case the maintenance should require the replacement of any component which forms part of an explosion-proof joint, only an original spare provided by Biffi MUST be used. Direct repair or reconstruction of the above components are not permitted without the Biffi permission. Not performing this procedure will invalidate the product safety and contractual guarantee.

Original spare parts must be required to the manufacturer: to ensure that right spare is provided, serial number printed on the ICON 2000 unit enclosure label must be specified when spares are ordered.

22 SAFETY INSTRUCTIONS

22.1 GENERAL

This Addendum B is an integration to ICON 2000 main IOM VCIOM-01232 to prescribe the safety instructions applicable to all the electric actuators Series ICON 2000 / ICON 2000 AD either as a base unit either when they are equipped with an optional extension [A] for additional entry mounted on the control compartment or when they are equipped with an optional extension [B] with additional entries or with an optional extension [C] with optional electronic card both mounted on the terminal board compartment, as identified by the pictures here below, when they are installed in Hazardous Areas as defined by the IEC/EN 60079-10-1 IEC/EN 60079-10-2. Under the same conditions, the optional extensions [A], [B] or [C], can be mounted on a base unit ICON 2000 / ICON 2000 AD already installed on field.

WARNING

It is assumed that the installation, setting, commissioning, maintenance and repair works are carried out by qualified personnel and checked by responsible specialists.

Both the base unit ICON 2000 / ICON 2000 AD and optional extension are designed in accordance with the applicable international rules and specifications but in any case the following regulation must be observed:

- The general installation and safety regulations.
- The proper use of personal protective devices (glasses, clothing, gloves).
- The proper use of tools, lifting and transport equipment.

22.2 IDENTIFICATION OF MAIN PARTS



Base unit



Base unit with extension [A]

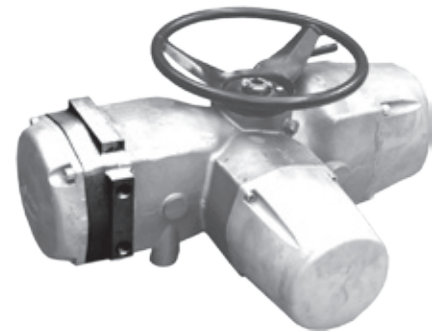

Base unit with extensions [B] or [C]

23 CHECK FOR RIGHT APPLICATION

WARNING

Before the installation it is mandatory to check if the nameplate associated to the extension for additional entry specifies the appropriate degree of protection and ambient temperature limits as requested by the rules applicable to the plant/ location where units are installed. Template of the label is attached here below.

Installation in ambient with the presence of explosive atmosphere not covered by the specified grade of protection, or which could reach temperature higher than the maximum specified on the label, will invalidate the safety and the warranty.

23.1 MARKING

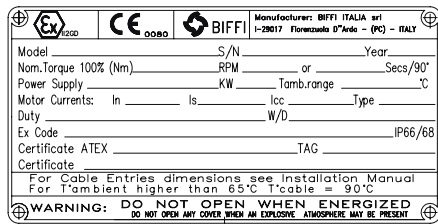

Template of the label for ICON 2000 / ICON 2000 AD

| | |
|-------------------|--|
| IECEX INE XX.ZZZZ | IECEX reference certificate [CoC] |
| XX ATEX ZZZZ | ATEX reference certificate |
| 0080 | Notified body for ATEX quality assurance (INERIS) |
| II | Group II (surface industries) |
| 2 | Category 2 apparatus |
| G | Explosive atmospheres caused by gas, mists or vapors |
| D | Explosive atmospheres caused by gas dusts |
| IP66/68 | Degree of protection |

| Hazardous zone | Zone | Categories according to 94/9/EC Directive |
|----------------------|------|---|
| Gas, mist or vapors | 0 | 1G |
| Gas, mists or vapors | 1 | 2G or 1G |
| Gas, mists or vapors | 2 | 3G or 2G or 1G |
| Dust | 20 | 1D |
| Dust | 21 | 2D or 1D |
| Dust | 22 | 3D or 2D or 1D |

EQUIPMENT PROTECTION LEVEL (EPL) EN 60079-14

| Explosive atmosphere | Zone | EPL |
|----------------------|------|----------------|
| Gas | 0 | Ga |
| Gas | 1 | Ga or Gb |
| Gas | 2 | Ga or Gb or Gc |
| Dust | 20 | Da |
| Dust | 21 | Da or Db |
| Dust | 22 | Da or Db or Dc |

24 APPLICABLE GENERAL STANDARDS AND REGULATIONS

| | |
|-------------------|--|
| 2006/42/EC | Machinery Directive |
| 2004/108/EC | EMC Directive |
| 2006/95/EC | Low Voltage Directive |
| 94/9/EC | ATEX Directive |
| EN ISO 12100-1 | Safety of machinery - Basic concepts, general principles for design. Part 1-Basic terminology, methodology |
| EN ISO 12100-2 | Safety of machinery - Basic concepts, general principles for design. Part 2-Technical principles and specification |
| EN 60079-0: 2009 | IEC 60079-0: 2011 |
| EN 60079-1: 2007 | IEC 60079-1: 2007 |
| EN 60079-7: 2007 | IEC 60079-7: 2006 |
| EN 60079-11: 2012 | IEC 60079-11: 2011 |
| EN 60079-31: 2009 | IEC 60079-31: 2008 |
| EN 13463-1: 2009 | |
| EN 13463-5: 2003 | |

25 TERMS AND CONDITIONS

Biffi guarantees each single product to be free from defects and to conform to current goods specifications. The warranty period is one year from the date of installation by the first user, or eighteen months from the date of shipment to the first user, whichever occurs first. No warranty is given for products or components manufactured by third-party companies, or for goods which have been subject to misuse, improper installation, corrosion, or which have been modified or repaired by unauthorized personnel. Repair work due to improper use will be charged at standard rates.

26 MANUFACTURER'S LIABILITY

- Biffi Italia declines all liability in the event of:
- Use of product in contravention of local safety at work legislation.
 - Incorrect installation, disregard or incorrect application of the instructions provided on the product nameplate and in VCIOM-01232 main Instruction and Operating Manual and relevant Addendum B.
 - Modification of the product without Biffi's authorization.
 - Work done on the product by unqualified or unsuitable personnel.

27 STORAGE AND PRE-INSTALLATION

27.1 STORAGE PROCEDURE

IMPORTANT

Not performing the following procedures will invalidate the product guarantee.

Normally the optional extension for additional entry/entries or additional electronic card are directly mounted on the base ICON 2000 / ICON 2000 AD by Biffi and leaves the factory in perfect condition. Under this condition the general storage procedure as stated in VCIOM-01232 main Instruction and Operating Manual must be applied.

When the above extensions are shipped separately for a field upgrading on existing ICON 2000 / ICON 2000 AD unit this must be stored in a protected area taking care that the explosion proof joints are well protected avoiding any damage to the joint surfaces. The standard plastic plugs used to protect the cable entry during the transport is not explosion proof nor water proof, it just prevent the entry of undesired objects during transport. The extension for additional entry/entries or additional electronic card maintain the same weatherproof degree of protection as the base ICON 2000 / ICON 2000 AD. This condition can only be maintained if the extension is correctly installed/connected on site and if it has been correctly stored.

27.2 CHECKS TO BE PERFORMED BEFORE INSTALLATION

Before to install the extension for additional entry/entries or additional electronic card in an existing unit ICON 2000 / ICON 2000 AD the following checks are recommended:

- The status of the joint surfaces.
- Status of the threads on the conduit entry.
- Whether the enclosure holding the additional conduit entry is cracked or broken.

28 INSTALLATION

IMPORTANT

The installation must be carried out in accordance to the applicable standards IEC/EN 60079-14 and IEC/EN 60079-17 regarding the electrical installations in Hazardous Areas (other than mines) classified as Zones 1, 2 (gas) and Zones 21, 22 (dust) following IEC/EN 60079-10-1 and IEC/EN 60079-10-2 and any other applicable national standards and rules.

28.1 WORKING CONDITION

WARNING

For the correct utilization with respect to the safety and the functionality of the enclosures components, check the "temperature ambient range" embossed on the nameplate.

28.1.1 Models and temperature

ICON-010 and ICON-020:

- from -60°C to +65°C (from -76°F to +149°F)
- from -60°C to +85°C (from -76°F to +185°F)

ICON-030, ICON-040 and ICON-050:

- from -55°C to +65°C (from -67°F to +149°F)
- from -55°C to +85°C (from -67°F to +185°F)

28.1.2 Base unit with extensions [A] or [B] or [C]

When on the foreseen extension is installed in an ICON 2000 / ICON 2000 AD unit the whole assembly is suitable for the following ambient temperatures:

ICON-010 and ICON-020:

- from -20°C to +65°C (from -4°F to +149°F)
- from -20°C to +85°C (from -4°F to +185°F)

ICON-030, ICON-040 and ICON-050:

- from -20°C to +65°C (from -4°F to +149°F)
- from -20°C to +85°C (from -4°F to +185°F)

for all models the maximum permissible temperature is depending from the type of motor (SM, TM or DM) installed on the base ICON 2000 / ICON 2000 AD unit.

28.2 IDENTIFICATION OF ENTRY

28.2.1 Base actuator

Electric Actuators Series ICON 2000 / ICON 2000 AD are equipped with 4 entries (3 are standard, the fourth is supplied when requested).

With reference to the attached picture, the thread form/size for each entry is as follows:

| Entry | Alternative | |
|--------------|-------------|-----------------------|
| | NPT size | (Metric size ISO 965) |
| 1 | 1" | M32x1.5 |
| 2 | 1-1/2" | M40x1.5 |
| 3 | 1" | M32x1.5 |
| 4 (optional) | 3/4" | M25x1.5 |

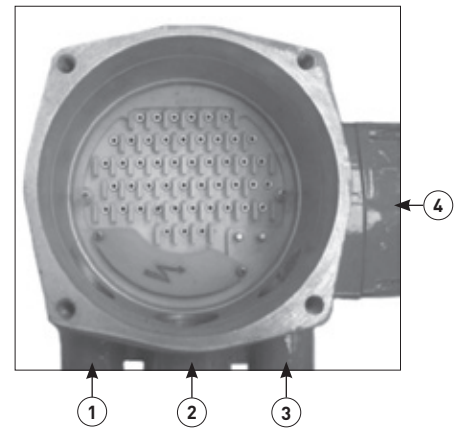

IMPORTANT

When alternative entries are used, indication of the dimensions is imprinted directly on the housing close to the entry.

WARNING

Unused entries may remain unmachined or must be plugged with a certified plug suitable for the area.

28.2.2 Base actuator with extension [A] on the control compartment

The extension [A] provide an additional entry for cable or conduit connection or for a connection of an external ATEX certified apparatus. With reference to the attached picture, the thread form/size for the entry is as follows:

| Entry | Standard size | Optional |
|-------|---------------|----------|
| 5 | M25x1.5 | N/A |



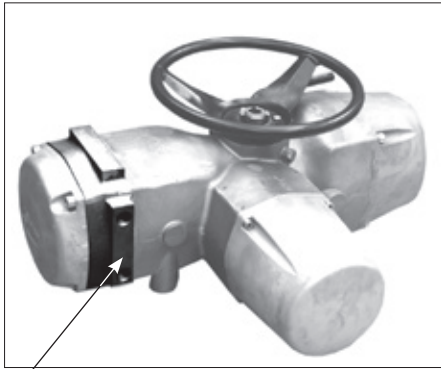

Entries from A to K



Internal earth stud



External earth stud

28.2.3 Base actuator with extensions [B] or [C] on the terminal board compartment

The extensions [B] or [C] provide up to 9 additional entries for cable or conduit connection. With reference to the attached picture, the thread form/size for the entries is as follows:

| Entries | Option 1 Standard entries | Option 2 Alternative entries (ISO 965) |
|------------------------------|---------------------------------|--|
| A, B, C, D, E, F, G, H, K | 1/2" NPT | M20x1.5 |

IMPORTANT

When alternative entries are used, indication of the dimensions is imprinted directly on the housing close to the entry.

WARNING

Unused entries may remain unmachined or must be plugged with a certified plug suitable for the area.

28.3 WIRING

The external wires or the connections of the external ATEX certified apparatus through the conduit entry of the additional extension, must be wired to the internal cards of the ICON 2000 / ICON 2000 AD in accordance to the wiring diagram and to the general instructions attached to the documentation of the base unit.

28.4 CABLE CONNECTION

When optional extension for additional entry/ entries or additional electronic card are used to connect external cables or conduits, the sealing of cables/conduits entries must be carried out in accordance with national standards or the regulatory authorities that have certified the extension with additional conduit entry. Method of sealing and cable glands must be approved and separately certified for use in hazardous areas.

Two earth points of connection, one internal and one external, are foreseen on the base ICON 2000 / ICON 2000 AD units enclosure for the ground cables connection.

IMPORTANT

To prevent any water infiltration through the line cable conduits, be sure the cable glands used have the minimum degree of protection required by the plant.

To guarantee that the weatherproof and explosion-proof characteristics are respected, screw the cable gland or the external ATEX certified apparatus tightly (at least 5 turns) and block them with a thread sealant.

IMPORTANT

The cables and cable glands MUST be selected considering the maximum temperature of the cable indicated on the label fixed to the base ICON 2000 unit.

28.5 INSTALLATION IN AMBIENT WITH EXPLOSIVE DUSTS

Special attention must do to these following points:

- Before the assembly the joint surfaces must be greased with Aeroshell grease.
- The cable glands must have a protection degree at minimum IP66 or IP68 (15 m depth / 90 hours) according to IEC/EN 60529 standard.
- Periodically verify the quantity of dust deposited on the enclosure and clean it in the case the quantity becoming more than 5 mm.

29 MAINTENANCE

WARNING

In case the units equipped with extension for additional entry or additional entries, already installed in HAZARDOUS AREAS, need maintenance and/or any repair work, this must be carried out by personnel specifically qualified and fully trained for works in HAZARDOUS AREAS.

29.1 PERIODIC INSPECTIONS

- Inspect the general conditions of the ICON 2000 / ICON 2000 AD plus the possible optional additional extension at regular intervals: recommended frequency of inspection is one time every two years but this frequency could be changed depending on the installation and working conditions: any crack on the surface, broken window or loose bolts must be reported for repair.
- Keep the external surfaces of the unit clean: if the unit is installed in a dusty environment the specification stated in IEC/EN 60079-14 to be followed ensuring in particular that the dust layer does not exceed 5 mm.
- Check the condition of cable connection and mounting bolts: any loose connection must be amended.

29.2 DISMANTLING AND REASSEMBLING

WARNING

In case the screws of the cover must be replaced, a SS AISI 316 Class A4 Grade 70, must be used with minimum yield strength of 450 N/mm².

In case a dismantling and subsequent reassembling of the explosion-proof enclosure is required, be careful to maintain all parts in their original condition.

So the following procedure must be followed:

- Do not damage the explosion-proof mating surfaces on the housing and on the electrical enclosure cover.

- Reinstall all the screws that go with the dismantled parts and block after spreading them with a film of molybdenum-based grease. This will keep screws from sticking and make maintenance future operations easier.
- In case the screws need to be changed it is mandatory to assure that the new screws are of the same dimension and same material as the original ones as stated in this manual, or of a better quality.
- Replace the weatherproof seals that may have been removed i.e: O-rings for the cover.
- In particular, be sure the joint surfaces of all enclosures are spread with a film of Aeroshell grease.

29.3 REPAIRS

When needed, repair must only be carried out with manufacturer's original spare parts.

WARNING

The values of gaps of explosion-proof joints are lower than the maximum specified on tables of IEC/EN 60079-1 Standard and the values of widths of the explosion-proof joints are superior to the values specified on tables of the Standard IEC/EN 60079-1. In case the maintenance should require the replacement of any component which forms part of an explosion-proof joint, only an original spare provided by Biffi MUST be used. Direct repair or reconstruction of the above components are not permitted without the Biffi permission. Not performing this procedure will invalidate the product safety and contractual guarantee.

Original spare parts must be required to the manufacturer: to ensure that right spare is provided, serial number printed on the ICON 2000 unit enclosure label must be specified when spares are ordered.

30 SAFETY INSTRUCTIONS

30.1 GENERAL

This Addendum C to ICON 2000 main IOM VCIOM-01232 prescribes the safety instructions applicable to all the electric actuators ICON 2000-010 and ICON 2000-020, certified according to the EN 60079-0 and IEC Standards 60079-1, 60079-11, 60079-31 for protection mode Ex d or Ex d ia for gas group IIC and Ex tb IIIC for dust suitable to be installed in an ambient temperature range from -60°C (-76°F) to +85°C (+185°F).

WARNING

It is assumed that the installation, setting, commissioning, maintenance and repair works are carried out by qualified personnel and checked by responsible specialists.

ICON 2000 is designed in accordance with the applicable international rules and specifications but in any case the following regulation must be observed:

- The general installation and safety regulations.
- The proper use of personal protective devices (glasses, clothing, gloves).
- The proper use of tools, lifting and transport equipment.

31 INSTRUCTIONS FOR RIGHT INSTALLATION

WARNING

Before the installation it is mandatory to check if the nameplate specifies the appropriate degree of protection and ambient temperature limits as requested by the rules applicable to the plant/ location where ICON 2000 are installed. Installation in ambient with the presence of explosive atmosphere not covered by the specified grade of protection, or which could reach temperature higher than the maximum specified on the label, will invalidate the safety and the warranty.

IMPORTANT

Check if the label, as the following example, is fixed on the unit and completed with all the appropriate information.



31.1 MARKING

| | | | |
|--|-----------|--|----------------|
| | | Manufacturer: BIFFI ITALIA P.le Europa D'Acero 28017 (PC) - ITALY | |
| Model _____ | S/N _____ | Year _____ | |
| Nom. Torque 100% (Nm) _____ | RPM _____ | or _____ | Secs/90° _____ |
| Power Supply _____ | KW _____ | Tolerance _____ | °C _____ |
| Motor Currents: In _____ Is _____ | Icc _____ | Type _____ | |
| Duty _____ | W/D _____ | | |
| Ex Code _____ | | | IP66/68 |
| Certificate ATEX _____ | TAG _____ | | |
| Certificate _____ | | | |
| For Cable Entries dimension see Installation Manual | | | |
| WARNING: DO NOT OPEN WHEN ENERGIZED | | | |
| DO NOT OPEN ANY COVER, WHEN AN EXPLOSIVE ATMOSPHERE MAY BE PRESENT | | | |

Template of the label for ICON 2000 / ICON 2000 AD

| | |
|-------------------|--|
| IECEX INE XX.ZZZZ | IECEX reference certificate (CoC) |
| XX ATEX ZZZZ | ATEX reference certificate |
| 0080 | Notified body for ATEX quality assurance (INERIS) |
| II | Group II (surface industries) |
| 2 | Category 2 apparatus |
| G | Explosive atmospheres caused by gas, mists or vapors |
| D | Explosive atmospheres caused by gas dusts |
| IP66/68 | Degree of protection |

| Hazardous zone | Zone | Categories according to 94/9/EC Directive |
|----------------------|------|---|
| Gas, mist or vapors | 0 | 1G |
| Gas, mists or vapors | 1 | 2G or 1G |
| Gas, mists or vapors | 2 | 3G or 2G or 1G |
| Dust | 20 | 1D |
| Dust | 21 | 2D or 1D |
| Dust | 22 | 3D or 2D or 1D |

EQUIPMENT PROTECTION LEVEL (EPL) EN 60079-14

| Explosive atmosphere | Zone | EPL |
|----------------------|------|----------------|
| Gas | 0 | Ga |
| Gas | 1 | Ga or Gb |
| Gas | 2 | Ga or Gb or Gc |
| Dust | 20 | Da |
| Dust | 21 | Da or Db |
| Dust | 22 | Da or Db or Dc |

32 APPLICABLE DIRECTIVES, GENERAL STANDARDS AND NORMS

| | |
|-------------------|--|
| 2006/42/EC | Machinery Directive |
| 2004/108/EC | EMC Directive |
| 2006/95/EC | Low Voltage Directive |
| 94/9/EC | ATEX Directive |
| EN ISO 12100-1 | Safety of machinery - Basic concepts, general principles for design. Part 1-Basic terminology, methodology |
| EN ISO 12100-2 | Safety of machinery - Basic concepts, general principles for design. Part 2-Technical principles and specification |
| EN 60079-0: 2009 | IEC 60079-0: 2011 |
| EN 60079-1: 2007 | IEC 60079-1: 2007 |
| EN 60079-7: 2007 | IEC 60079-7: 2006 |
| EN 60079-11: 2012 | IEC 60079-11: 2011 |
| EN 60079-31: 2009 | IEC 60079-31: 2008 |
| EN 13463-1: 2009 | |
| EN 13463-5: 2003 | |

33 TERMS AND CONDITIONS

Biffi Italia guarantees each single product to be free from defects and to conform to current goods specifications. Except when differently specified, the warranty period is one year from the date of installation by the first user, or eighteen months from the date of shipment to the first user, whichever occurs first.

No warranty is given for products which have been subject to improper storage, improper installation, misuse, or which have been modified or repaired by unauthorized personnel.

Repair works due to improper use will be charged at standard rates.

34 MANUFACTURER'S LIABILITY

Biffi Italia declines all liability in the event of:

- Use of product in contravention of local safety at work legislation.
- Incorrect installation, disregard or incorrect application of the instructions provided on the product nameplate and in VCIOM-01232 main Instruction and Operating Manual and relevant Addendum C.
- Modification of the product without Biffi's authorisation.
- Work done on the product by unqualified or unsuitable personnel.

35 STORAGE AND PRE-INSTALLATION

35.1 STORAGE PROCEDURE

IMPORTANT

Not performing the following procedures will invalidate the product guarantee.

Normally the optional extension for additional entry/entries or additional electronic card are directly mounted on the base ICON 2000 / ICON 2000 AD by Biffi and leaves the factory in perfect condition. Under this condition the general storage procedure as stated in the main IOM must be applied.

When the above extensions are shipped separately for a field upgrading on existing ICON 2000 / ICON 2000 AD unit this must be stored in a protected area taking care that the explosion proof joints are well protected avoiding any damage to the joint surfaces. The standard plastic plugs used to protect the cable entry during the transport is not explosion proof nor water proof, it just prevent the entry of undesired objects during transport. The extension for additional entry/entries or additional electronic card maintain the same weatherproof degree of protection as the base ICON 2000 / ICON 2000 AD. This condition can only be maintained if the extension is correctly installed/connected on site and if it has been correctly stored.

35.2 CHECKS TO BE PERFORMED BEFORE INSTALLATION

Before to install the extension for additional entry/entries or additional electronic card in an existing unit ICON 2000 / ICON 2000 AD the following checks are recommended:

- The status of the joint surfaces.
- Status of the threads on the conduit entry.
- Whether the enclosure holding the additional conduit entry is cracked or broken.

36 INSTALLATION

IMPORTANT

The installation must be carried out in accordance to the applicable standards IEC/EN 60079-14 and IEC/EN 60079-17 regarding the electrical installations in Hazardous Areas (other than mines) classified as Zones 1, 2 (gas) and Zones 21, 22 (dust) following IEC/EN 60079-10-1 and IEC/EN 60079-10-2 and any other applicable national standards and rules.

36.1 WORKING CONDITION

WARNING

For the correct utilisation with respect to the safety and the functionality of the enclosures components, check the "temperature ambient range" embossed on the nameplate.

36.1.1 Models and temperature

ICON-010 and ICON-020:

- from -60°C to +65°C (from -76°F to +149°F)

36.2 IDENTIFICATION OF ENTRY

36.2.1 Base actuator

Electric Actuators Series ICON 2000 / ICON 2000 AD are equipped with 4 entries (3 are standard, the fourth is supplied when requested).

With reference to the attached picture, the thread form/size for each entry is as follows:

| Entry | NPT size | Alternative (Metric size ISO 965) |
|--------------|----------|-----------------------------------|
| 1 | 1" | M32x1.5 |
| 2 | 1-1/2" | M40x1.5 |
| 3 | 1" | M32x1.5 |
| 4 (optional) | 3/4" | M25x1.5 |

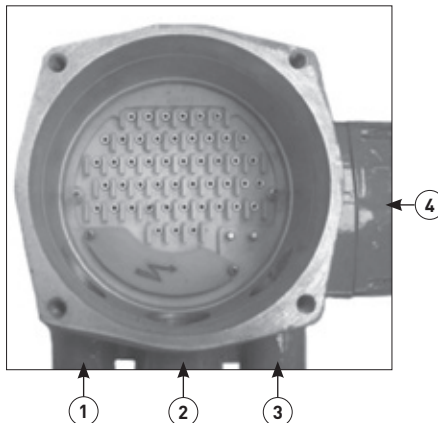

IMPORTANT

When alternative entries according ISO 965 are used, indication of the dimensions is imprinted on the adaptor bush or directly on the housing when ISO 965 entries are obtained by machining the housing.

36.3 ELECTRICAL CONNECTIONS

The instructions of VCIOM-01232 main Instruction and Operating Manual applies.

36.4 CABLE CONNECTION

Sealing of cables entries must be carried out in accordance with national standards or the regulatory authorities that have certified the extension with additional conduit entry.

Method of sealing and cable glands must be approved and separately certified for use in hazardous areas.

Two earth points of connection, one internal and one external, are foreseen on the base ICON 2000 units enclosure for the ground cables connection.

IMPORTANT

To prevent any water infiltration through the line cable conduits, be sure the cable glands used have the minimum degree of protection required by the plant and specified on the actuator label.

To guarantee that the weatherproof and explosion-proof characteristics are respected, screw the cable gland or the external ATEX certified apparatus tightly (at least 5 turns) and block them with a thread sealant.

IMPORTANT

The cables and cable glands MUST be selected considering the maximum temperature of the cable indicated on the label fixed to the base ICON 2000 unit.

36.5 INSTALLATION IN AMBIENT WITH EXPLOSIVE DUSTS

Special attention must do to these following points:

- Before the assembly the joint surfaces must be greased with Aeroshell grease.
- The cable glands must have a protection degree at minimum IP66 or IP68 (15 m depth / 90 hours) according to IEC/EN 60529 standard.
- Periodically verify the quantity of dust deposited on the enclosure and clean it in the case the quantity becoming more than 5 mm.



Internal earth stud



External earth stud

37 MAINTENANCE

WARNING

In case the unit already installed in HAZARDOUS AREAS, need maintenance and/or any repair work, this must be carried out by personnel specifically qualified and fully trained for works in HAZARDOUS AREAS.

37.1 PERIODIC INSPECTIONS

- Inspect the general conditions of the ICON 2000 at regular intervals: recommended frequency of inspection is one time every two years but this frequency could be changed depending on the installation and working conditions: any crack on the surface, broken window or loose bolts must be reported for repair.
- Keep the external surfaces of the unit clean: if the unit is installed in a dusty environment the specification stated in IEC/EN 60079-14 to be followed ensuring in particular that the dust layer does not exceed 5 mm.
- Check the condition of cable connection and mounting bolts: any loose connection must be amended.

37.2 DISMANTLING AND REASSEMBLING

WARNING

In case the screws of the Ex-d covers must been replaced, a SS AISI 316 Class A4 Grade 70, must be used with minimum yield strength of 450 N/mm².

In case a dismantling and subsequent reassembling of the explosion-proof enclosure is required, be careful to maintain all parts in their original condition.

So the following procedure must be followed:

- Do not damage the explosion-proof mating surfaces on the housing and on the electrical enclosure cover.

- Reinstall all the screws that go with the dismantled parts and block after spreading them with a film of molybdenum-based grease. This will keep screws from sticking and make maintenance future operations easier.
- In case the screws need to be changed it is mandatory to assure that the new screws are of the same dimension and same material as the original ones as stated in this manual, or of a better quality.
- Replace the weatherproof seals that may have been removed i.e: O-rings for the cover.
- In particular, be sure the joint surfaces of all enclosures are spread with a film of Aeroshell grease.

37.3 REPAIRS

When needed, repair must only be carried out with manufacturer's original spare parts.

WARNING

The values of gaps of explosion-proof joints are lower than the maximum specified on tables of IEC/EN 60079-1 Standard. In case the maintenance should require the replacement of any component which forms part of an explosion-proof joint, only an original spare provided by Biffi MUST be used. Direct repair or reconstruction of the above components are not permitted without the Biffi permission. Not performing this procedure will invalidate the product safety and contractual guarantee.

Original spare parts must be required to the manufacturer: to ensure that right spare is provided, serial number printed on the ICON 2000 unit enclosure label must be specified when spares are ordered.

38 SAFETY INSTRUCTIONS

38.1 GENERAL

This Addendum D to ICON 2000 main IOM VCIOM-01232 prescribes the safety instructions applicable to all the electric actuators ICON 2000-010, ICON-020, ICON-030, certified according to the IEC/EN 60079-0, 60079-1, 60079-7, 60079-11 and 60079-31 standards, for protection mode Ex d e and gas group IIC suitable to be installed in an ambient temperature range from -25°C (-13°F) to +60°C (+140°F).

WARNING

It is assumed that the installation, setting, commissioning, maintenance and repair works are carried out by qualified personnel and checked by responsible specialists.

ICON 2000 is designed in accordance with the applicable international rules and specifications but in any case the following regulation must be observed:

- The general installation and safety regulations.
- The proper use of personal protective devices (glasses, clothing, gloves).
- The proper use of tools, lifting and transport equipment.

39 INSTRUCTIONS FOR RIGHT INSTALLATION

WARNING

Before the installation it is mandatory to check if the nameplate specifies the appropriate degree of protection and ambient temperature limits as requested by the rules applicable to the plant/ location where ICON 2000 are installed. Installation in ambient with the presence of explosive atmosphere not covered by the specified grade of protection, or which could reach temperature higher than the maximum specified on the label, will invalidate the safety and the warranty.

IMPORTANT

Check if the label, as the following example, is fixed on the unit and completed with all the appropriate information.



39.1 MARKING

| | | | | |
|---|-----------|--|----------------|----------|
| | | Manufacturer: BIFFI ITALIA P.le Europa D'Acero 28017 (PC) - ITALY | | |
| Model _____ | S/N _____ | Year _____ | | |
| Nom.Torque 100% (Nm) _____ | RPM _____ | or _____ | Secs/90° _____ | °C _____ |
| Power Supply _____ | KW _____ | Tolerance _____ | | |
| Motor Currents: In _____ Is _____ | Icc _____ | Type _____ | | |
| Duty _____ | W/D _____ | | | |
| Ex Code _____ | IP66/68 | | | |
| Certificate ATEX _____ | TAG _____ | | | |
| Certificate _____ | | | | |
| For Cable Entries dimension see Installation Manual | | | | |
| WARNING: DO NOT OPEN WHEN ENERGIZED | | | | |
| DO NOT OPEN ANY COVER WHEN AN EXPLOSIVE ATMOSPHERE MAY BE PRESENT | | | | |

Template of the label for ICON 2000 / ICON 2000 AD

| | |
|-------------------|--|
| IECEX INE XX.ZZZZ | IECEX reference certificate (CoC) |
| XX ATEX ZZZZ | ATEX reference certificate |
| 0080 | Notified body for ATEX quality assurance (INERIS) |
| II | Group II (surface industries) |
| 2 | Category 2 apparatus |
| G | Explosive atmospheres caused by gas, mists or vapors |
| D | Explosive atmospheres caused by gas dusts |
| IP66/68 | Degree of protection |

| Hazardous zone | Zone | Categories according to 94/9/EC Directive |
|----------------------|------|---|
| Gas, mist or vapors | 0 | 1G |
| Gas, mists or vapors | 1 | 2G or 1G |
| Gas, mists or vapors | 2 | 3G or 2G or 1G |
| Dust | 20 | 1D |
| Dust | 21 | 2D or 1D |
| Dust | 22 | 3D or 2D or 1D |

EQUIPMENT PROTECTION LEVEL (EPL) EN 60079-14

| Explosive atmosphere | Zone | EPL |
|----------------------|------|----------------|
| Gas | 0 | Ga |
| Gas | 1 | Ga or Gb |
| Gas | 2 | Ga or Gb or Gc |
| Dust | 20 | Da |
| Dust | 21 | Da or Db |
| Dust | 22 | Da or Db or Dc |

40 APPLICABLE DIRECTIVES, GENERAL STANDARDS AND NORMS

| | |
|-------------------|--|
| 2006/42/EC | Machinery Directive |
| 2004/108/EC | EMC Directive |
| 2006/95/EC | Low Voltage Directive |
| 94/9/EC | ATEX Directive |
| EN ISO 12100-1 | Safety of machinery - Basic concepts, general principles for design. Part 1-Basic terminology, methodology |
| EN ISO 12100-2 | Safety of machinery - Basic concepts, general principles for design. Part 2-Technical principles and specification |
| EN 60079-0: 2009 | IEC 60079-0: 2011 |
| EN 60079-1: 2007 | IEC 60079-1: 2007 |
| EN 60079-7: 2007 | IEC 60079-7: 2006 |
| EN 60079-11: 2012 | IEC 60079-11: 2011 |
| EN 60079-31: 2009 | IEC 60079-31: 2008 |
| EN 13463-1: 2009 | |
| EN 13463-5: 2003 | |

41 TERMS AND CONDITIONS

Biffi Italia guarantees each single product to be free from defects and to conform to current goods specifications. Except when differently specified, the warranty period is one year from the date of installation by the first user, or eighteen months from the date of shipment to the first user, whichever occurs first.

No warranty is given for products which have been subject to improper storage, improper installation, misuse, or which have been modified or repaired by unauthorized personnel.

Repair works due to improper use will be charged at standard rates.

42 MANUFACTURER'S LIABILITY

Biffi Italia declines all liability in the event of:

- Use of product in contravention of local safety at work legislation.
- Incorrect installation, disregard or incorrect application of the instructions provided on the product nameplate and in VCIOM-01232 main Instruction and Operating Manual and relevant Addendum D.
- Modification of the product without Biffi's authorisation.
- Work done on the product by unqualified or unsuitable personnel.

43 STORAGE AND PRE-INSTALLATION

43.1 STORAGE PROCEDURE

IMPORTANT

Not performing the following procedures will invalidate the product guarantee.

Normally the optional extension for additional entry/entries or additional electronic card are directly mounted on the base ICON 2000 / ICON 2000 AD by Biffi and leaves the factory in perfect condition. Under this condition the general storage procedure as stated in the main IOM must be applied.

When the above extensions are shipped separately for a field upgrading on existing ICON 2000 / ICON 2000 AD unit this must be stored in a protected area taking care that the explosion proof joints are well protected avoiding any damage to the joint surfaces. The standard plastic plugs used to protect the cable entry during the transport is not explosion proof nor water proof, it just prevent the entry of undesired objects during transport. The extension for additional entry/entries or additional electronic card maintain the same weatherproof degree of protection as the base ICON 2000 / ICON 2000 AD. This condition can only be maintained if the extension is correctly installed/connected on site and if it has been correctly stored.

43.2 CHECKS TO BE PERFORMED BEFORE INSTALLATION

Before to install the extension for additional entry/entries or additional electronic card in an existing unit ICON 2000 / ICON 2000 AD the following checks are recommended:

- The status of the joint surfaces.
- Status of the threads on the conduit entry.
- Whether the enclosure holding the additional conduit entry is cracked or broken.

44 INSTALLATION

IMPORTANT

The installation must be carried out in accordance to the applicable standards IEC/EN 60079-14 and IEC/EN 60079-17 regarding the electrical installations in Hazardous Areas (other than mines) classified as Zones 1, 2 (gas) and Zones 21, 22 (dust) following IEC/EN 60079-10-1 and IEC/EN 60079-10-2 and any other applicable national standards and rules.

44.1 WORKING CONDITION

WARNING

For the correct utilisation with respect to the safety and the functionality of the enclosures components, check the "temperature ambient range" embossed on the nameplate.

44.1.1 Models and temperature

ICON-010, ICON-020 and ICON-030:

- from -25°C to +60°C (from -13°F to +140°F)

44.2 IDENTIFICATION OF ENTRIES

44.2.1 Base actuator

Electric actuators Series ICON 2000 / ICON 2000 AD are equipped with 4 entries (3 are standard, the fourth is supplied when requested).

With reference to the attached picture, the thread form/size for each entry is as follows:

| Entry | NPT size | Alternative (Metric size ISO 965) |
|--------------|----------|-----------------------------------|
| 1 | 1" | M32x1.5 |
| 2 | 1-1/2" | M40x1.5 |
| 3 | 1" | M32x1.5 |
| 4 (optional) | 3/4" | M25x1.5 |

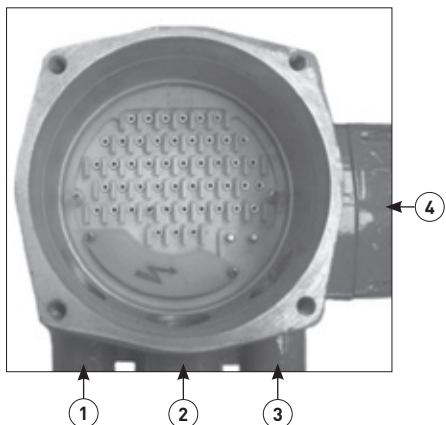

IMPORTANT

When alternative entries according ISO 965 are used, indication of the dimensions is imprinted on the adaptor bush or directly on the housing when ISO 965 entries are obtained by machining the housing.

44.3 ELECTRICAL CONNECTIONS

The instructions of VCIOM-01232 main Instruction and Operating Manual applies.

44.4 CABLE CONNECTION

Sealing of cables entries must be carried out in accordance with national standards or the regulatory authorities that have certified the extension with additional conduit entry. Method of sealing and cable glands must be approved and separately certified for use in hazardous areas.

Two earth points of connection, one internal and one external, are foreseen on the base ICON 2000 units enclosure for the ground cables connection.

IMPORTANT

To prevent any water infiltration through the line cable conduits, be sure the cable glands used have the minimum degree of protection required by the plant and specified on the actuator label.

To guarantee that the weatherproof and explosion-proof characteristics are respected, screw the cable gland or the external ATEX certified apparatus tightly (at least 5 turns) and block them with a thread sealant.

IMPORTANT

The cables and cable glands MUST be selected considering the maximum temperature of the cable indicated on the label fixed to the base ICON 2000 unit.

44.5 INSTALLATION IN AMBIENT WITH EXPLOSIVE DUSTS

Special attention must do to these following points:

- Before the assembly the joint surfaces must be greased with Aeroshell grease.
- The cable glands must have a protection degree at minimum IP66 or IP68 (15 m depth / 90 hours) according to IEC/EN 60529 standard.
- Periodically verify the quantity of dust deposited on the enclosure and clean it in the case the quantity becoming more than 5 mm.



Internal earth stud



External earth stud

45 MAINTENANCE

WARNING

In case the unit already installed in HAZARDOUS AREAS, need maintenance and/or any repair work, this must be carried out by personnel specifically qualified and fully trained for works in HAZARDOUS AREAS.

45.1 PERIODIC INSPECTIONS

- Inspect the general conditions of the ICON 2000 at regular intervals: recommended frequency of inspection is one time every two years but this frequency could be changed depending on the installation and working conditions: any crack on the surface, broken window or loose bolts must be reported for repair.
- Keep the external surfaces of the unit clean: if the unit is installed in a dusty environment the specification stated in IEC/EN 60079-14 to be followed ensuring in particular that the dust layer does not exceed 5 mm.
- Check the condition of cable connection and mounting bolts: any loose connection must be amended.

45.2 DISMANTLING AND REASSEMBLING

WARNING

In case the screws of the Ex-d covers must be replaced, a SS AISI 316 Class A4 Grade 70, must be used with minimum yield strength of 450 N/mm².

In case a dismantling and subsequent reassembling of the explosion-proof enclosure is required, be careful to maintain all parts in their original condition.

So the following procedure must be followed:

- Do not damage the explosion-proof mating surfaces on the housing and on the electrical enclosure cover.

- Reinstall all the screws that go with the dismantled parts and block after spreading them with a film of molybdenum-based grease. This will keep screws from sticking and make maintenance future operations easier.
- In case the screws need to be changed it is mandatory to assure that the new screws are of the same dimension and same material as the original ones as stated in this manual, or of a better quality.
- Replace the weatherproof seals that may have been removed i.e: O-rings for the cover.
- In particular, be sure the joint surfaces of all enclosures are spread with a film of Aeroshell grease.

45.3 REPAIRS

When needed, repair must only be carried out with manufacturer's original spare parts.

WARNING

The values of gaps of explosion-proof joints are lower than the maximum specified on tables of IEC/EN 60079-1 Standard. In case the maintenance should require the replacement of any component which forms part of an explosion-proof joint, only an original spare provided by Biffi MUST be used. Direct repair or reconstruction of the above components are not permitted without the Biffi permission. Not performing this procedure will invalidate the product safety and contractual guarantee.

Original spare parts must be required to the manufacturer: to ensure that right spare is provided, serial number printed on the ICON 2000 unit enclosure label must be specified when spares are ordered.

46 SAFETY INSTRUCTIONS

46.1 GENERAL

This Addendum E to ICON 2000 main IOM VCIOM-01232 prescribes the safety instructions applicable to all the electric actuators ICON 2000-010, ICON-020, ICON-030, certified according to the IEC/EN 60079-0, 60079-1, 60079-7, 60079-11 and 60079-31 standards, for protection mode Ex d e and gas group IIC suitable to be installed in an ambient temperature range from -25°C (-13°F) to +60°C (+140°F).

WARNING

It is assumed that the installation, setting, commissioning, maintenance and repair works are carried out by qualified personnel and checked by responsible specialists.

ICON 2000 is designed in accordance with the applicable international rules and specifications but in any case the following regulation must be observed:

- The general installation and safety regulations.
- The proper use of personal protective devices (glasses, clothing, gloves).
- The proper use of tools, lifting and transport equipment.

47 INSTRUCTIONS FOR RIGHT INSTALLATION

WARNING

Before the installation it is mandatory to check if the nameplate specifies the appropriate degree of protection and ambient temperature limits as requested by the rules applicable to the plant/ location where ICON 2000 are installed. Installation in ambient with the presence of explosive atmosphere not covered by the specified grade of protection, or which could reach temperature higher than the maximum specified on the label, will invalidate the safety and the warranty.

IMPORTANT

Check if the label, as the following example, is fixed on the unit and completed with all the appropriate information.



47.1 MARKING

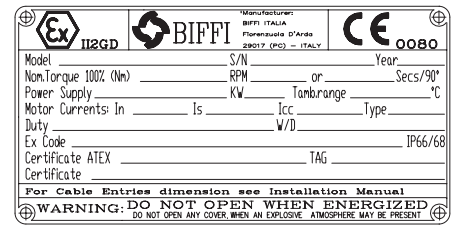

Template of the label for ICON 2000 / ICON 2000 AD

| | |
|-------------------|--|
| IECEX INE XX.ZZZZ | IECEX reference certificate (CoC) |
| XX ATEX ZZZZ | ATEX reference certificate |
| 0080 | Notified body for ATEX quality assurance (INERIS) |
| II | Group II (surface industries) |
| 2 | Category 2 apparatus |
| G | Explosive atmospheres caused by gas, mists or vapors |
| D | Explosive atmospheres caused by gas dusts |
| IP66/68 | Degree of protection |

| Hazardous zone | Zone | Categories according to 94/9/EC Directive |
|----------------------|------|---|
| Gas, mist or vapors | 0 | 1G |
| Gas, mists or vapors | 1 | 2G or 1G |
| Gas, mists or vapors | 2 | 3G or 2G or 1G |
| Dust | 20 | 1D |
| Dust | 21 | 2D or 1D |
| Dust | 22 | 3D or 2D or 1D |

EQUIPMENT PROTECTION LEVEL (EPL) EN 60079-14

| Explosive atmosphere | Zone | EPL |
|----------------------|------|----------------|
| Gas | 0 | Ga |
| Gas | 1 | Ga or Gb |
| Gas | 2 | Ga or Gb or Gc |
| Dust | 20 | Da |
| Dust | 21 | Da or Db |
| Dust | 22 | Da or Db or Dc |

48 APPLICABLE DIRECTIVES, GENERAL STANDARDS AND NORMS

| | |
|-------------------|--|
| 2006/42/EC | Machinery Directive |
| 2004/108/EC | EMC Directive |
| 2006/95/EC | Low Voltage Directive |
| 94/9/EC | ATEX Directive |
| EN ISO 12100-1 | Safety of machinery - Basic concepts, general principles for design. Part 1-Basic terminology, methodology |
| EN ISO 12100-2 | Safety of machinery - Basic concepts, general principles for design. Part 2-Technical principles and specification |
| EN 60079-0: 2009 | IEC 60079-0: 2011 |
| EN 60079-1: 2007 | IEC 60079-1: 2007 |
| EN 60079-7: 2007 | IEC 60079-7: 2006 |
| EN 60079-11: 2012 | IEC 60079-11: 2011 |
| EN 60079-31: 2009 | IEC 60079-31: 2008 |
| EN 13463-1: 2009 | |
| EN 13463-5: 2003 | |

49 TERMS AND CONDITIONS

Biffi Italia guarantees each single product to be free from defects and to conform to current goods specifications. Except when differently specified, the warranty period is one year from the date of installation by the first user, or eighteen months from the date of shipment to the first user, whichever occurs first.

No warranty is given for products which have been subject to improper storage, improper installation, misuse, or which have been modified or repaired by unauthorized personnel.

Repair works due to improper use will be charged at standard rates.

50 MANUFACTURER'S LIABILITY

Biffi Italia declines all liability in the event of:

- Use of product in contravention of local safety at work legislation.
- Incorrect installation, disregard or incorrect application of the instructions provided on the product nameplate and in VCIOM-01232 main Instruction and Operating Manual and relevant Addendum E.
- Modification of the product without Biffi's authorisation.
- Work done on the product by unqualified or unsuitable personnel.

51 STORAGE AND PRE-INSTALLATION

51.1 STORAGE PROCEDURE

IMPORTANT

Not performing the following procedures will invalidate the product guarantee.

Normally the optional extension for additional entry/entries or additional electronic card are directly mounted on the base ICON 2000 / ICON 2000 AD by Biffi and leaves the factory in perfect condition. Under this condition the general storage procedure as stated in the main IOM must be applied.

When the above extensions are shipped separately for a field upgrading on existing ICON 2000 / ICON 2000 AD unit this must be stored in a protected area taking care that the explosion proof joints are well protected avoiding any damage to the joint surfaces. The standard plastic plugs used to protect the cable entry during the transport is not explosion proof nor water proof, it just prevent the entry of undesired objects during transport. The extension for additional entry/entries or additional electronic card maintain the same weatherproof degree of protection as the base ICON 2000 / ICON 2000 AD. This condition can only be maintained if the extension is correctly installed/connected on site and if it has been correctly stored.

51.2 CHECKS TO BE PERFORMED BEFORE INSTALLATION

Before to install the extension for additional entry/entries or additional electronic card in an existing unit ICON 2000 / ICON 2000 AD the following checks are recommended:

- The status of the joint surfaces.
- Status of the threads on the conduit entry.
- Whether the enclosure holding the additional conduit entry is cracked or broken.

52 INSTALLATION

IMPORTANT

The installation must be carried out in accordance to the applicable standards IEC/EN 60079-14 and IEC/EN 60079-17 regarding the electrical installations in Hazardous Areas (other than mines) classified as Zones 1, 2 (gas) and Zones 21, 22 (dust) following IEC/EN 60079-10-1 and IEC/EN 60079-10-2 and any other applicable national standards and rules.

52.1 WORKING CONDITION

WARNING

For the correct utilisation with respect to the safety and the functionality of the enclosures components, check the "temperature ambient range" embossed on the nameplate.

52.1.1 Models and temperature

ICON-010, ICON-020 and ICON-030, ICON-040, ICON-050:

- from -25°C to +60°C (from -13°F to +140°F)

52.2 IDENTIFICATION OF ENTRIES

52.2.1 Base actuator

Electric actuators Series ICON 2000 are equipped with 4 entries (3 are standard, the fourth is supplied when requested).

With reference to the attached picture, the thread form/size for each entry is as follows:

| Entry | NPT size | Alternative (Metric size ISO 965) |
|--------------|----------|-----------------------------------|
| 1 | 1" | M32x1.5 |
| 2 | 1-1/2" | M40x1.5 |
| 3 | 1" | M32x1.5 |
| 4 (optional) | 3/4" | M25x1.5 |

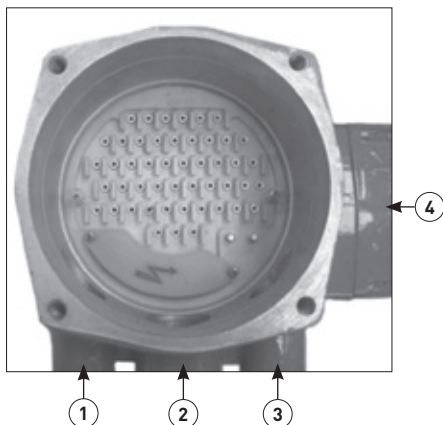

IMPORTANT

When alternative entries according ISO 965 are used, indication of the dimensions is imprinted on the adaptor bush or directly on the housing when ISO 965 entries are obtained by machining the housing.

52.3 ELECTRICAL CONNECTIONS

The instructions of VCIOM-01232 main Instruction and Operating Manual applies.

52.4 CABLE CONNECTION

Sealing of cables entries must be carried out in accordance with national standards or the regulatory authorities that have certified the extension with additional conduit entry.

Method of sealing and cable glands must be approved and separately certified for use in hazardous areas.

Two earth points of connection, one internal and one external, are foreseen on the base ICON 2000 units enclosure for the ground cables connection.

IMPORTANT

To prevent any water infiltration through the line cable conduits, be sure the cable glands used have the minimum degree of protection required by the plant and specified on the actuator label.

To guarantee that the weatherproof and explosion-proof characteristics are respected, screw the cable gland or the external ATEX certified apparatus tightly (at least 5 turns) and block them with a thread sealant.

IMPORTANT

The cables and cable glands MUST be selected considering the maximum temperature of the cable indicated on the label fixed to the base ICON 2000 unit.

52.5 INSTALLATION IN AMBIENT WITH EXPLOSIVE DUSTS

Special attention must do to these following points:

- Before the assembly the joint surfaces must be greased with Aeroshell grease.
- The cable glands must have a protection degree at minimum IP66 or IP68 (15 m depth / 90 hours) according to IEC/EN 60529 standard.
- Periodically verify the quantity of dust deposited on the enclosure and clean it in the case the quantity becoming more than 5 mm.



Internal earth stud



External earth stud

53 MAINTENANCE

WARNING

In case the unit already installed in HAZARDOUS AREAS, need maintenance and/or any repair work, this must be carried out by personnel specifically qualified and fully trained for works in HAZARDOUS AREAS.

53.1 PERIODIC INSPECTIONS

- Inspect the general conditions of the ICON 2000 at regular intervals: recommended frequency of inspection is one time every two years but this frequency could be changed depending on the installation and working conditions: any crack on the surface, broken window or loose bolts must be reported for repair.
- Keep the external surfaces of the unit clean: if the unit is installed in a dusty environment the specification stated in IEC/EN 60079-14 to be followed ensuring in particular that the dust layer does not exceed 5 mm.
- Check the condition of cable connection and mounting bolts: any loose connection must be amended.

53.2 DISMANTLING AND REASSEMBLING

WARNING

In case the screws of the Ex-d covers must been replaced, a SS AISI 316 Class A4 Grade 70, must be used with minimum yield strength of 450 N/mm².

In case a dismantling and subsequent reassembling of the explosion-proof enclosure is required, be careful to maintain all parts in their original condition.

So the following procedure must be followed:

- Do not damage the explosion-proof mating surfaces on the housing and on the electrical enclosure cover.

- Reinstall all the screws that go with the dismantled parts and block after spreading them with a film of molybdenum-based grease. This will keep screws from sticking and make maintenance future operations easier.
- In case the screws need to be changed it is mandatory to assure that the new screws are of the same dimension and same material as the original ones as stated in this manual, or of a better quality.
- Replace the weatherproof seals that may have been removed i.e: O-rings for the cover.
- In particular, be sure the joint surfaces of all enclosures are spread with a film of Aeroshell grease.

53.3 REPAIRS

When needed, repair must only be carried out with manufacturer's original spare parts.

WARNING

The values of gaps of explosion-proof joints are lower than the maximum specified on tables of IEC/EN 60079-1 Standard. In case the maintenance should require the replacement of any component which forms part of an explosion-proof joint, only an original spare provided by Biffi MUST be used. Direct repair or reconstruction of the above components are not permitted without the Biffi permission. Not performing this procedure will invalidate the product safety and contractual guarantee.

Original spare parts must be required to the manufacturer: to ensure that right spare is provided, serial number printed on the ICON 2000 unit enclosure label must be specified when spares are ordered.



Biffi reserves the the right to change product designs and specifications without notice.

Biffi Italia S.r.L.

Località Caselle San Pietro, 420, 29017 Fiorenzuola d'Arda (PC) ITALY Ph: +39 (0)523 944 411 E-mail: biffi_italia@biffi.it www.biffi.it