

Rosemount 1056

Dual-Input Intelligent Analyzer

- **Multiparameter instrument** – single or dual input. Choose from pH/ORP ISE, Resistivity/Conductivity, % Concentration, Chlorine, Oxygen, Ozone, Temperature, Turbidity, Flow, and 420 mA Current Input.
- **Large display** – large easy-to-read process measurements.
- **Easy to install** – modular boards, removable connectors, easy to wire power, sensors, and outputs.
- **Intuitive menu screens** – with advanced diagnostics and help screens.
- **Seven languages** included: English, French, German, Italian, Spanish, Portuguese, and Chinese.
- **HART® and PROFIBUS® DP Digital Communications** options.

Features and Applications

The Rosemount 1056 dual-input analyzer offers single or dual sensor input with an unrestricted choice of dual measurements. This multi-parameter instrument offers a wide range of measurement choices supporting most industrial, commercial, and municipal applications. The modular design allows signal input boards to be field replaced making configuration changes easy. Conveniently, live process values are always displayed during programming and calibration routines.

Quick Start Programming

Exclusive Quick Start screens appear the first time the Rosemount 1056 is powered. The instrument autorecognizes each measurement board and prompts the user to configure each sensor loop in a few quick steps for immediate deployment.

Digital Communications

HART® and Profibus® DP digital communications are available. The 1056 HART units communicate with the 375 HART® handheld communicator and HART hosts, such as AMS Intelligent Device Manager. The 1056 Profibus units are fully compatible with Profibus DP networks and Class 1 or Class 2 masters. HART and Profibus DP configured units will support any single or dual measurement configurations of 1056.



Rosemount 1056 Dual-Input Intelligent Analyzer.

Menus

Menu screens for calibrating and programming are simple and intuitive. Plain language prompts and help screens guide the user through these procedures.

Dual Sensor Input and Output

The Rosemount 1056 accepts single or dual sensor input. Standard 0/4–20 mA current outputs can be programmed to correspond to any measurement or temperature.

Enclosure

The instrument fits standard ½ DIN panel cutouts. The versatile enclosure design supports panelmount, pipemount, and surface/wallmount installations.

Isolated Inputs

Inputs are isolated from other signal sources and earth ground. This ensures clean signal inputs for single and dual input configurations. For dual input configurations, isolation allows any combination of measurements and signal inputs without cross-talk or signal interference.

Temperature

Most measurements require temperature compensation. The Model 1056 will automatically recognize Pt100, Pt1000 or 22k NTC RTDs built into the sensor.

Security Access Codes

Two levels of security access are available. Program one access code for routine calibration and hold of current outputs; program another access code for all menus and functions.

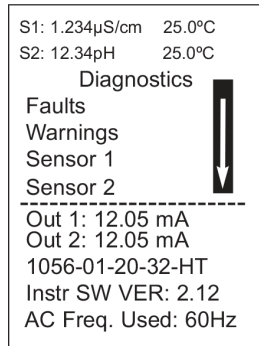

Information about each condition is quickly accessible by pressing DIAG on the keypad. User help screens are displayed for most fault and warning conditions to assist in trouble shooting.

Display

The highcontrast LCD provides live measurement readouts in large digits and shows up to four additional process variables or diagnostic parameters. The display is backlit and the format can be customized to meet user requirements.

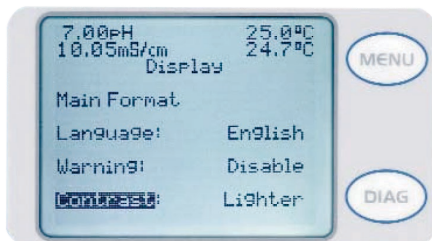

Local Languages

Rosemount extends its worldwide reach by offering seven local languages – English, French, German, Italian, Spanish, Portuguese, and Chinese. Every unit includes user programming menus; calibration routines; faults and warnings; and user help screens in all seven languages. The displayed language can be easily set and changed using the menus.



Current Outputs

Two 4–20 mA or 0–20 mA current outputs are electrically isolated. Outputs are fully scalable and can be programmed to linear or logarithmic modes. Output dampening can be enabled with time constants from 0 to 999 seconds. Output 1 includes digital signal 4–20 mA superimposed HART® (option HT only).

Descriptions and Specifications

Special Measurements

The Rosemount 1056 offers measuring capabilities for many applications.

- J **Single or dual turbidity:** Ideal in municipal applications for measurement of low-NTU filtered drinking water. Must be used with Clarity II sensor, sensor cable and debubbler.
- J **Four-electrode conductivity:** The 1056 is compatible with Rosemount Analytical four-electrode 410VP in the PUR-Sense™ family of conductivity sensors. This sensor supports a wide array of applications and is capable of measuring a large range of conductivity with one geometri configuration. Wired to the 1056, this sensor can measure 2 µS/cm to 300 mS/cm with an accuracy of 4 % of reading throughout the entire range.
- J **4–20 mA current input:** Accepts any analog current input from an external device for temperature compensation of measurements and atmospheric pressure input for partial pressure correction of oxygen.
- J **Selective ions:** The analyzer is able to measure ammonia and fluoride using commercially available ionselective electrodes. All analyzers with installed pH boards can be programmed to measure selective ions.
- J **pH independent free chlorine:** With the 498Cl-01 sensor, the analyzer is able to measure free chlorine with automatic correction for process pH without the need for a pH sensor.
- J **Inferential pH:** The analyzer is able to derive and display inferred pH (pHCalc) using two contacting conductivity signal boards and the appropriate contacting conductivity sensors. This method will calculate the pH of condensate and boiler water from conductivity and cation conductivity measurements.
- J **Differential conductivity:** Dual input conductivity configurations can measure differential conductivity. The analyzer can be programmed to display dual conductivity as ratio, % rejection, or % passage.

Specifications

General

Enclosure: Polycarbonate. Type 4X, IP65.



Dimensions: Overall 155 x 155 x 131mm (6.10 x 6.10 x 5.15 in.). Cutout: 1/2 DIN 139mm x 139mm (5.45 x 5.45 in.)

Conduit Openings: Accepts 1/2" or PG13.5 conduit fittings

Display: Monochromatic graphic liquid crystal display. 128 x 96 pixel display resolution. Backlit. Active display area: 58 x 78mm (2.3 x 3.0 in.).

Ambient Temperature and Humidity: 0 to 55 °C (32 to 131 °F). Turbidity only: 0 to 50 °C (32 to 122 °F)

Hazardous Location Approvals Options for CSA: 01, 02, 03, 20, 21, 22, 24, 25, 26, 27, 30, 31, 32, 34, 35, 36, 37, 38, AN, and HT.

 -LR 34186 Class I, Division 2, Groups A, B, C, & D
 C US Class II, Division 2, Groups E, F, & G
 Class III T4A Tamb= 50°C

Evaluated to the ANSI/UL Standards. The 'C' and 'US' indicators adjacent to the CSA Mark signify that the product has been evaluated to the applicable CSA and ANSI/UL Standards, for use in Canada and the U.S. respectively.

Options for CSA: -01, 02, 03, 20, 21, 22, 24, 25, 26, 27, 30, 31, 32, 34, 35, 36, 37, 38, AN, and HT.

NOTE: Turbidity configurations (Models 1056-02-27-38-AN/-HT, 1056-03-27-38-AN/-HT, 1056-02-27-37-AN/-HT and 1056-03-27-37-AN/-HT) are FM approved Class I Div.2 for hazardous area installation.

 APPROVED Class I, Division 2, Groups A, B, C, & D
 Class II & III, Division 2, Groups E, F, & G
 T4A Tamb= 50°C Enclosure Type 4X

Options for UL: 01, 02, 03, 20, 21, 22, 24, 25, 26, 27, 30, 31, 32, 34, 35, 36, 37, 38, AN, and HT.

Ordinary Locations: (only with -UL ordering option)



POLLUTION DEGREE 2: Normally only nonconductive pollution occurs. Occasionally, however, a temporary conductivity caused by condensation must be expected.

Altitude: for use up to 2000 meter (6562 ft.)

 Equipment protected by double insulation.

Power: Code -01: 115 VAC ±15 % 60 Hz ±6 %, 10 W.
 230 VAC ±15% 50 Hz ±6 %, 10 W.

Code 02: 20 to 30 VDC. 15 W.

Code 03: 84 to 265 VAC, 47 to 63.0 Hz. 15 W.

Note: Code 02 and 03 power supplies include 4 programmable relays.

RFI/EMI: EN61326 
LVD: EN610101

Alarms relays (1): Four alarm relays for process measurement (s) or temperature. Any relay can be configured as a fault alarm instead of a process alarm. Each relay can be configured independently and each can be programmed with interval timer settings.

Relays: Form C, SPDT, epoxy sealed



Maximum Relay Current	
	Resistive
28 VDC	5.0 A
115 VAC	5.0 A
230 VAC	5.0 A

Inductive load: 1/8 HP motor (max.), 40 VAC
 Maximum screw torque for power lead connector and relay terminal blocks is 0.6 N.m

 CAUTION
Risk of Electrical Shock

(1) Relays only available with 02 power supply (20 30 VDC) or 03 switching power supply (84–265 VAC)

Inputs: One or two isolated sensor inputs

⚠ WARNING
Exposure to so chemicals may degrade the sealing properties used in the following devices: Zettler Relays (K1-K4) PN AZ8-1CH-12DSEA

Outputs: Two 4–20 mA or 0–20 mA isolated current outputs. Fully scalable. Max Load: 550 Ohm. Output 1 has superimposed HART signal (configurations 1056-0X-2X-3X-HT only).

Current Output Accuracy: ±0.05 mA @ 25 °C Terminal

Connections Rating: Power connector (3leads): 1812 AWG wire size.

Signal board terminal blocks: 2616 AWG wire size.

Current output connectors (2leads): 2416 AWG wire size.

Alarm relay terminal blocks: 1816 AWG wire size (02 24 VDC power supply and -03 84–265 VAC power supply)

Weight/Shipping Weight: (rounded up to nearest lb or nearest 0.5 kg): 3 lbs/4 lbs (1.5 kg/2.0 kg)

Contacting Conductivity (Codes -02 and -30)

Measures conductivity in the range 0 to 600,000 µS/cm (600 mS/cm). Measurement choices are conductivity, resistivity, total dissolved solids, salinity, and % concentration. The % concentration selection includes the choice of five common solutions (0–12 % NaOH, 0–15 % HCl, 0–20 % NaCl, and 0–25 % or 96–99.7 % H₂SO₄).

The conductivity concentration algorithms for these solutions are fully temperature compensated. Three temperature compensation options are available: manual slope (X%/ °C), high purity water (dilute sodium chloride), and cation conductivity (dilute hydrochloric acid). Temperature compensation can be disabled, allowing the analyzer to display raw conductivity. For more information concerning the use and operation of the contacting conductivity sensors, refer to the product data sheets.

Note: When two contacting conductivity sensors are used, the 1056 can derive an inferred pH value called pHCalc. pHCalc is calculated pH, not directly measured pH. (Model 1056-01-20-30-AN required)

Note: Selected four-electrode, high-range contacting conductivity sensors are compatible with the 1056.

Input filter: time constant 1–999 sec, default 2 sec.

Response time: 3 seconds to 100 % of final reading

Salinity: uses Practical Salinity Scale

Total Dissolved Solids: Calculated by multiplying conductivity at 25 °C by 0.65

Table 1 - Temperature Specifications

Temperature range	0–150 °C
Temperature Accuracy, Pt-1000, 0–150 °C	0–150 °C
Temperature Accuracy, Pt-1000, Temp. > 50 °C	0–150 °C

Recommended Sensors for Conductivity

All Rosemount ENDURANCE™ 400 series conductivity sensors (Pt 1000 RTD) and 410 sensor.

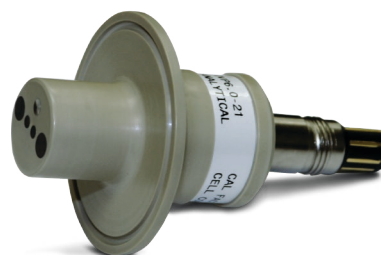

PUR-Sense™ family of four-electrode sensor.







ENDURANCE™ series of conductivity sensors.

Performance Specifications

Recommended Range – Contacting Conductivity

Cell Constant	0.01 $\mu\text{S}/\text{cm}$	0.1 $\mu\text{S}/\text{cm}$	1.0 $\mu\text{S}/\text{cm}$	10 $\mu\text{S}/\text{cm}$	100 $\mu\text{S}/\text{cm}$	1000 $\mu\text{S}/\text{cm}$	10 mS/cm	100 mS/cm	1000 mS/cm
0.01	0.01 $\mu\text{S}/\text{cm}$ to 200 $\mu\text{S}/\text{cm}$					200 $\mu\text{S}/\text{cm}$ to 6000 $\mu\text{S}/\text{cm}$			
0.1	0.1 $\mu\text{S}/\text{cm}$ to 2000 $\mu\text{S}/\text{cm}$					2000 $\mu\text{S}/\text{cm}$ to 60 mS/cm			
	1 $\mu\text{S}/\text{cm}$ to 20 mS/cm					220 mS/cm to 600 mS/cm			
						2 $\mu\text{S}/\text{cm}$ to 300 mS/cm			

Cell Constant Linearity

-  $\pm 0.6\%$ of reading in recommended range
-  $+2$ to 10% of reading outside high recommended range
-  $\pm 5\%$ of reading outside low recommended range
-  $\pm 4\%$ of reading in recommended range

- Repeatability:** $\pm 0.25\%$ $\pm 5 \mu\text{S}/\text{cm}$ after zero cal
- Input filter:** time constant 1–999 sec, default 2 sec.
- Response time:** 3 seconds to 100 % of final reading
- Salinity:** uses Practical Salinity Scale
- Total Dissolved Solids:** Calculated by multiplying conductivity at 25 °C by 0.65

Toroidal Conductivity (Codes -21 and -31)

Measures conductivity in the range of 1 (one) $\mu\text{S}/\text{cm}$ to 2,000,000 $\mu\text{S}/\text{cm}$ (2 S/cm). Measurement choices are conductivity, resistivity, total dissolved solids, salinity, and % concentration. The % concentration selection includes the choice of five common solutions (0–12 % NaOH, 0–15 % HCl, 0–20 % NaCl, and 0–25 % or 9699.7 % H_2SO_4). The conductivity concentration algorithms for these solutions are fully temperature compensated. For other solutions, a simple-to-use menu allows the customer to enter his own data. The analyzer accepts as many as five data points and fits either a linear (two points) or a quadratic function (three or more points) to the data. Two temperature compensation options are available: manual slope (X %/°C) and neutral salt (dilute sodium chloride). Temperature compensation can be disabled, allowing the analyzer to display raw conductivity. Reference temperature and linear temperature slope may also be adjusted for optimum results. For more information concerning the use and operation of the toroidal conductivity sensors, refer to the product data sheets.

Table 2 - Temperature Specifications

Temperature range	25 to 210 °C (-13 to 410 °F)
Temperature Accuracy, Pt-100, -25 to 50 °C	± 0.5 °C
Temperature Accuracy, Pt-100, 50 to 210 °C	± 1 °C

Recommended Sensors

All Rosemount submersion/immersion and flow-through toroidal sensors.









High performance toroidal conductivity sensors 226 and 225.

Performance Specifications

Recommended Range – Toroidal Conductivity

Model	1 $\mu\text{S/cm}$	10 $\mu\text{S/cm}$	100 $\mu\text{S/cm}$	1000 $\mu\text{S/cm}$	10 mS/cm	100 mS/cm	1000 mS/cm	2000 mS/cm
226	5 $\mu\text{S/cm}$ to 500 mS/cm				500 mS/cm to 2000 mS/cm			
225 and 228	15 $\mu\text{S/cm}$ to 1500 mS/cm				1500 mS/cm to 2000 mS/cm			
242	100 $\mu\text{S/cm}$ to 2000 mS/cm							
222 (1 in and 2 in)	500 $\mu\text{S/cm}$ to 2000 mS/cm							

Loop Performance (Following Calibration)

-  Rosemount 226: $\pm 1\%$ of reading $\pm 5 \mu\text{S/cm}$ in recommended range
-  Rosemount 225 & 228: $\pm 1\%$ of reading $\pm 10 \mu\text{S/cm}$ in recommended range
-  Rosemount 222,242: $\pm 4\%$ of reading in recommended range
-  Rosemount 225, 226 & 228: $\pm 5\%$ of reading outside high recommended range
-  Rosemount 226: $\pm 5 \mu\text{S/cm}$ outside low recommended range
-  Rosemount 225 & 228: $\pm 15 \mu\text{S/cm}$ outside low recommended range

pH/ORP/ISE

(Codes -22 and -32)

For use with any standard pH or ORP sensor. Measurement choices are pH, ORP, Redox, ammonia, fluoride or custom ISE. The automatic buffer recognition feature uses stored buffer values and their temperature curves for the most common buffer standards available worldwide. The analyzer will recognize the value of the buffer being measured and perform a self stabilization check on the sensor before completing the calibration. Manual or automatic temperature compensation is menu selectable. Change in pH due to process temperature can be compensated using a programmable temperature coefficient. For more information concerning the use and operation of the pH or ORP sensors, refer to the product data sheets.

The 1056 can also derive an inferred pH value called pHCalc (calculated pH). pHCalc can be derived and displayed when two contacting conductivity sensors are used. (Model 1056012030AN).

Performance Specifications - Analyzer (pH Input)

Measurement Range [pH]: 0 to 14 pH

Accuracy: ± 0.01 pH

Diagnostics: Glass impedance, reference impedance

Temperature coefficient: ± 0.002 pH/°C

Solution temperature correction: Pure water, dilute base and custom.

Buffer recognition: NIST, DIN 19266, JIS 8802, and BSI.

Input filter: Time constant 1–999 sec, default 4 sec.

Response time: 5 seconds to 100 %

Table 3 - Temperature Specifications

Temperature range	0–150 °C
Temperature Accuracy, Pt-100, 0–50 °C	± 0.5 °C
Temperature Accuracy, Temp. > 50 °C	± 1 °C

Performance Specifications - Analyzer (ORP Input)

Measurement Range [ORP]: -1500 to +1500 mV

Accuracy: ± 1 mV

Temperature coefficient: ± 0.12 mV/°C

Input filter: Time constant 1–999 sec, default 4 sec.

Response time: 5 seconds to 100 % of final reading

Recommended Sensors for pH:

All standard pH sensors.

Recommended Sensors for ORP:

All standard ORP sensors.



General purpose and high performance pH sensors 396P, 3900, and 3300HT.

Flow (Codes -23 and -33)

For use with most pulse signal flow sensors, the 1056 user-selectable units of measurement include flow rates in GPM (Gallons per minute), GPH (Gallons per hour), cu ft/min (cubic feet per min), cu ft/hour (cubic feet per hour), LPM (liters per minute), LPH (liters per hour), or m³/hr (cubic meters per hour), and velocity in ft/sec or m/sec. When configured to measure flow, the unit also acts as a totalizer in the chosen unit (gallons, liters, or cubic meters).

Dual flow instruments can be configured as a % recovery, flow difference, flow ratio, or total (combined) flow.

Performance Specifications

Frequency Range: 3 to 1000 Hz

Flow Rate: 0–99,999 GPM, LPM, m³/hr, GPH, LPH, cu ft/min, cu ft/hr.

Totalized Flow: 0 – 9,999,999,999,999 Gallons or m³, 0–999,999,999 cu ft.

Accuracy: 0.5 %

Input filter: Time constant 0999 sec., default 5 sec.

4–20 mA Current Input (Codes -23 and -33)

For use with any transmitter or external device that transmits 4–20 mA or 0–20 mA current outputs. Typical uses are for temperature compensation of live measurements (except ORP, turbidity and flow) and for continuous atmospheric pressure input for determination of partial pressure, needed for compensation of live gaseous oxygen measurements. External input of atmospheric pressure for oxygen measurement allows continuous partial pressure compensation while the 1056 enclosure is completely sealed.

Externally sourced current input is also useful for calibration of new or existing sensors that require temperature measurement or atmospheric pressure inputs.

In addition to live continuous compensation of live measurements, the current input board can also be used simply to display the measured temperature, or the calculated partial pressure from the external device. This feature leverages the large display variables on the 1056 as a convenience for technicians. Temperature can be displayed in degrees °C or degrees °F. Partial pressure can be displayed in inches Hg, mm Hg, atm (atmospheres), kPa (kiloPascals), bar or mbar.

The current input board can be used with devices that do not actively power their 4–20 mA output signals. The 1056 actively powers to the + and – lines of the current input board to enable current input from a 4-20 mA output device.

Performance Specifications

Measurement Range [mA] ⁽¹⁾: 0–20 or 4–20

Accuracy: ±0.03 mA

Input filter: Time constant 0–999 sec., default 5 sec.

(1) Current input not exceeded 22 mA

Chlorine (Codes -24 and -34)

Free and Total Chlorine

The Rosemount 1056 is compatible with the 499 ACL01-free chlorine sensor and the 499 ACL-02 total chlorine sensor. The 499 ACL-02 sensor must be used with the Model TCL total chlorine sample conditioning system. The 1056 fully compensates free and total chlorine readings for changes in membrane permeability caused by temperature changes. For free chlorine measurements, both automatic and manual pH correction are available. For automatic pH correction select code 32 and an appropriate pH sensor. For more information concerning the use and operation of the amperometric chlorine sensors and the TCL measurement system, refer to the product data sheets.

Performance Specifications

Resolution: 0.001 ppm or 0.01 ppm – selectable

Input Range: 0 nA – 100 μ A

Automatic pH correction (requires Code 32): 6.0 to 10.0 pH

Temperature compensation: Automatic (via RTD) or manual (0–50 °C).

Input filter: Time constant 1 999 sec, default 5 sec.

Response time: 6 seconds to 100 % of final reading

Recommended Sensors *

Chlorine: 499ACL-01 Free Chlorine or 499ACL-02 Total Residual Chlorine

pH: The following pH sensors are recommended for automatic pH correction of free chlorine readings: 399-09-62, 399-14, and 399VP-09

Monochloramine

The Rosemount 1056 is compatible with the 499ACL-03 Monochloramine sensor. The 1056 fully compensates readings for changes in membrane permeability caused by temperature changes. Because monochloramine measurement is not affected by pH of the process, no pH sensor or correction is required. For more information concerning the use and operation of the amperometric chlorine sensors, refer to the product data sheets.

Performance Specifications

Resolution: 0.001 ppm or 0.01 ppm – selectable

Input Range: 0 nA–100 μ A

Temperature compensation: Automatic (via RTD) or manual (0–50 °C).

Input filter: Time constant 1–999 sec, default 5 sec.

Response time: 6 seconds to 100 % of final reading

Recommended Sensors

Rosemount 499ACL-03 Monochloramine sensor.

pH-Independent Free Chlorine

The Rosemount 1056 is compatible with the 498CL-01 pH-independent free chlorine sensor. The 498CL-01 sensor is intended for the continuous determination of free chlorine (hypochlorous acid plus hypochlorite ion) in water. The primary application is measuring chlorine in drinking water. The sensor requires no acid pretreatment, nor is an auxiliary pH sensor required for pH correction. The 1056 fully compensates free chlorine readings for changes in membrane permeability caused by temperature. For more information concerning the use and operation of the amperometric chlorine sensors, refer to the product data sheets.

Performance Specifications

Resolution: 0.001 ppm or 0.01 ppm – selectable

Input Range: 0 nA–100 μ A

Automatic pH correction: 6.5 to 10.0 pH

Temperature compensation: Automatic (via RTD) or manual (0–50 °C).

Input filter: Time constant 1–999 sec, default 5 sec.

Response time: 6 seconds to 100 % of final reading.

Recommended Sensors

Rosemount 498CL-01 pH independent free chlorine sensor.



Chlorine sensors with Variopol connection and cable connection - 498CL-01.

Dissolved Oxygen (Codes -25 and -35)

The Rosemount 1056 is compatible with the 499ADO, 499ATrDO, Hx438, and Gx438 dissolved oxygen sensors and the Model 4000 percent oxygen gas sensor. The Model 1056 displays dissolved oxygen in ppm, mg/L, ppb, µg/L, % saturation, % O₂ in gas, ppm O₂ in gas. The analyzer fully compensates oxygen readings for changes in membrane permeability caused by temperature changes. An atmospheric pressure sensor is included on all dissolved oxygen signal boards to allow automatic atmospheric pressure determination at the time of calibration. If removing the sensor from the process liquid is impractical, the analyzer can be calibrated against a standard instrument. Calibration can be corrected for process salinity. For more information on the use of amperometric oxygen sensors, refer to the product data sheets.

Performance Specifications

Resolution: 0.01 ppm; 0.1 ppb for 499A TrDO sensor (when O₂ < 1.00 ppm); 0.1 %

Input Range: 0 nA–100 µA

Temperature Compensation: Automatic (via RTD) or manual (0–50 °C). **Input filter:** Time constant 1–999 sec, default 5 sec.

Response time: 6 seconds to 100 % of final reading

Recommended Sensors

Rosemount amperometric membrane and steam-sterilizable sensors listed above.



Dissolved Oxygen sensor with Variopol connection - 499ADO.

Dissolved Ozone (Codes -26 and -36)

The Rosemount 1056 is compatible with the 499AOZ sensor. The 1056 fully compensates ozone readings for changes in membrane permeability caused by temperature changes. For more information concerning the use and operation of the amperometric ozone sensors, refer to the product data sheets.

Performance Specifications

Resolution: 0.001 ppm or 0.01 ppm – selectable

Input Range: 0 nA–100 µA

Temperature Compensation: Automatic (via RTD) or manual (035°C)

Input filter: Time constant 1–999 sec, default 5 sec.

Response time: 6 seconds to 100 % of final reading

Recommended Sensors

Rosemount 499A OZ ozone sensor.



Dissolved Ozone sensors with Polysulfone body Variopol connection and cable connection - 499AOZ.

Turbidity (Codes -27 and -37)

The Rosemount 1056 instrument is available in single and dual turbidity configurations for the Clarity II turbidimeter. It is intended for the determination of turbidity in filtered drinking water. The other components of the Clarity II turbidimeter – sensor(s), debubbler/measuring chamber(s), and cable for each sensor must be ordered separately or as a complete system with the 1056.

The 1056 turbidity instrument accepts inputs from both USEPA 180.1 and ISO 7027-compliant sensors.

When ordering the Model 1056 turbidity instrument, the -02 (24 VDC power supply) or the -03 (switching 85-265 VAC power supply) are required. Both of these power supplies include four fully programmable relays with timers.

Note: The 1056 Turbidity must be used with Clarity II sensor, sensor cable and debubbler.

(Codes -27 and -37)

The Rosemount 1056 instrument is available in single and dual turbidity configurations for the Clarity II turbidimeter. It is intended for the determination of turbidity in filtered drinking water. The other components of the Clarity II turbidimeter – sensor(s), debubbler/measuring chamber(s), and cable for each sensor must be ordered separately or as a complete system with the 1056.

The 1056 turbidity instrument accepts inputs from both USEPA 180.1 and ISO 7027-compliant sensors.

When ordering the Model 1056 turbidity instrument, the -02 (24 VDC power supply) or the -03 (switching 85-265 VAC power supply) are required. Both of these power supplies include four fully programmable relays with timers.

Note: The 1056 Turbidity must be used with Clarity II sensor, sensor cable and debubbler.



T1056 Clarity II Turbidimeter

Quick Start Guide

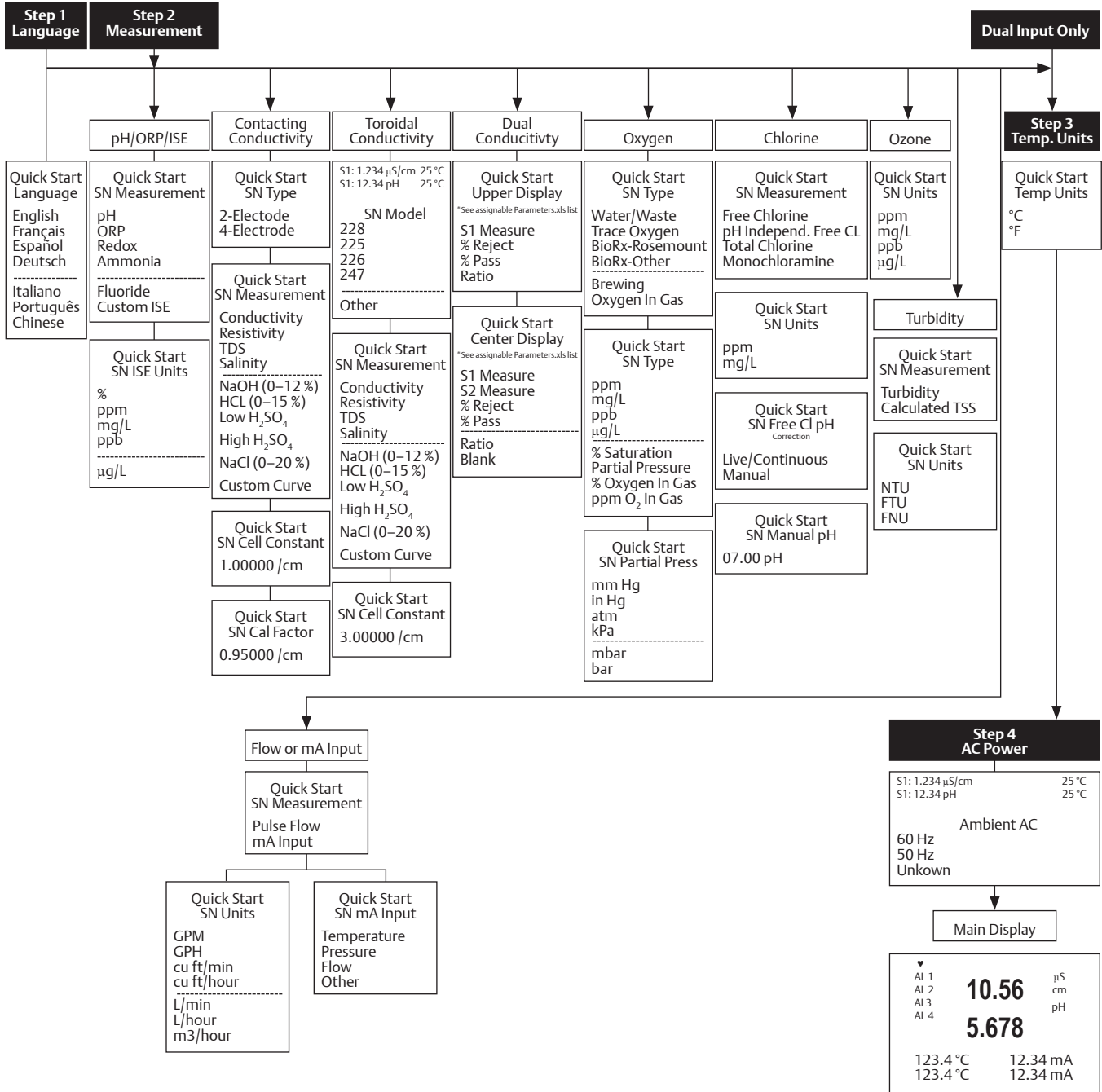

Panel Mount Dimensions

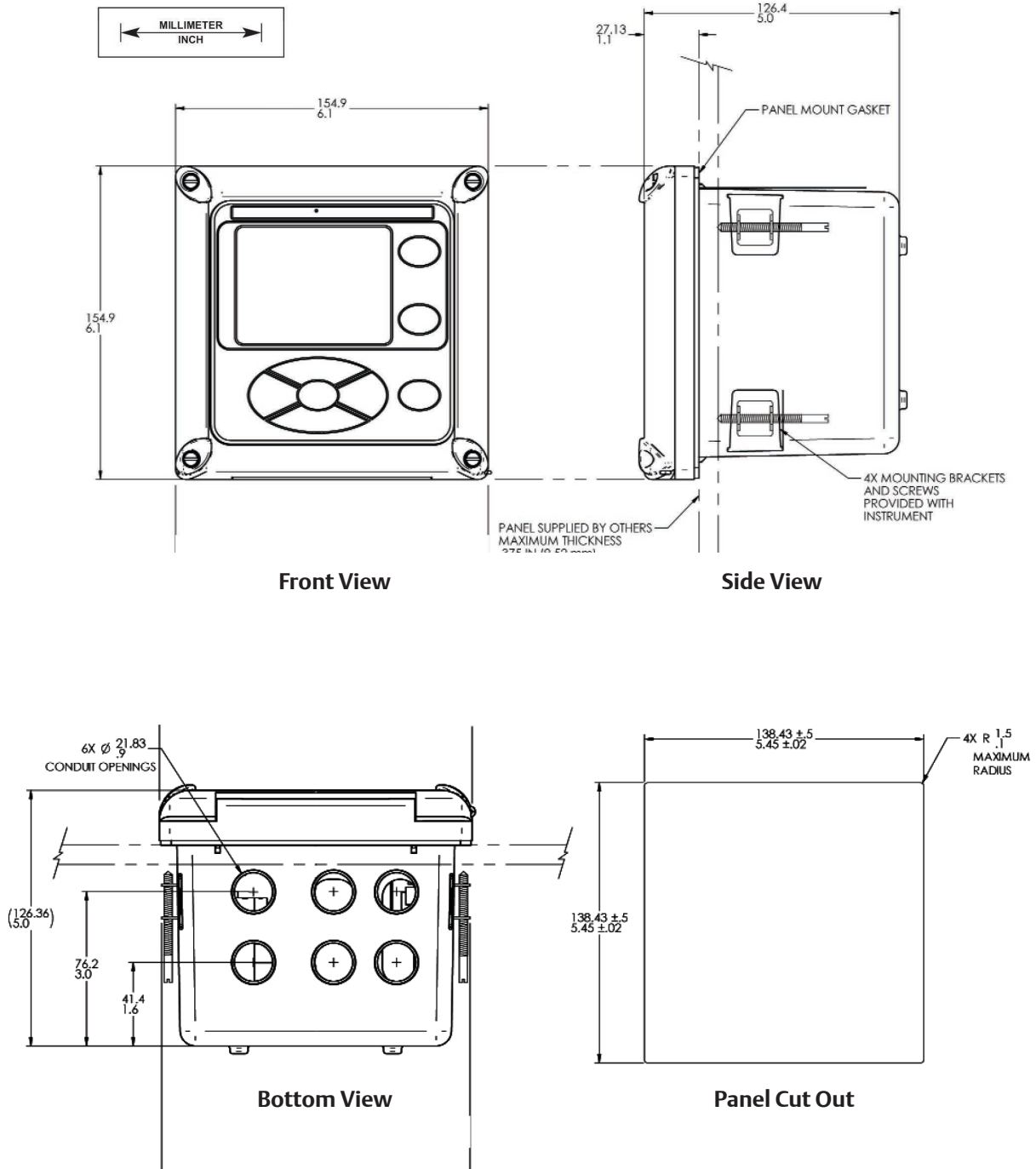

The front panel is hinged at the bottom. The panel swings down for easy access to the wiring locations. Panel mounting seal integrity (4/4x) for outdoor applications is the responsibility of the end user.

Pipe/Wall Mount Dimensions

(Mounting bracket PN:23820-00)

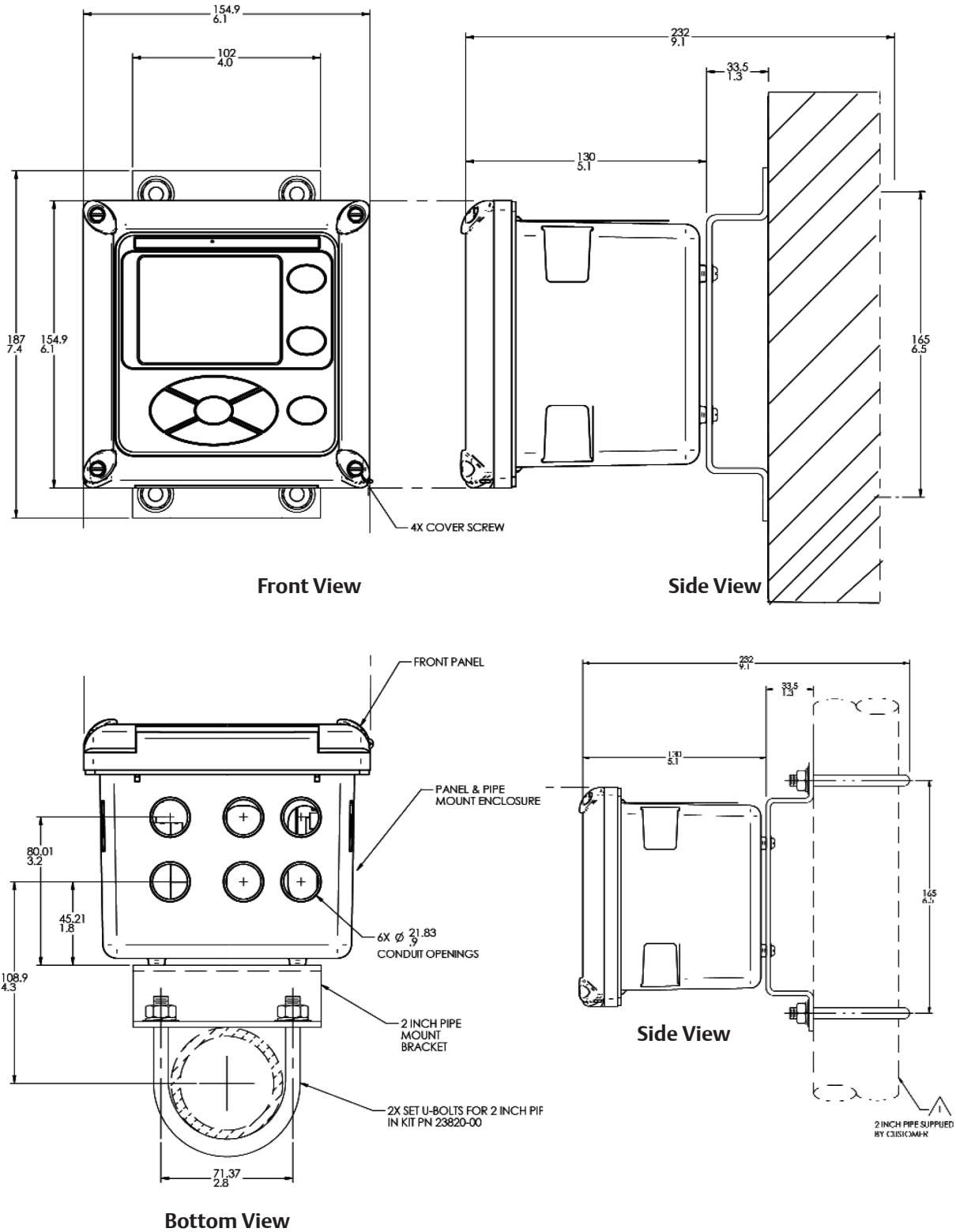

The front panel is hinged at the bottom. The panel swings down for easy access to the wiring locations.

Ordering Information

The Rosemount 1056 dual-input analyzer offers single or dual sensor input with an unrestricted choice of dual measurements thus reducing the cost per loop and saving panel space. This multiparameter instrument offers a wide range of measurement choices supporting most industrial, commercial, and municipal applications. Standard features include two isolated inputs, seven local languages, two 4–20 mA current outputs, removable connectors for line power and current outputs, four solid plugs for closure of openings, and panel mount hardware. HART® and Profibus® DP are available as a digital communications ordering option and will support all single and dual measurement configurations.

Table 4 - 1056 Dual-Input Intelligent Analyzer Ordering Information

1056 Dual-Input Intelligent Analyzer	
Code	Power
01	115/230 VAC, 50/60 Hz no relays
02	24 VDC with four alarm relays
03	85-265 VAC switching, 50/60 Hz with four alarm relays
Code	Measurement 1
20	Contacting Conductivity
21	Toroidal Conductivity
22	pH/ORP
23	Flow/Current Input (requires -02 or -03 power supply)
24	Chlorine
25	Dissolved Oxygen
26	Ozone
27	Turbidity (requires 02 or 03 power supply)
Code	Measurement 2
30	Contacting Conductivity
31	Toroidal Conductivity
32	pH/ORP
33	Flow/Current Input (requires -02 or -03 power supply)
34	Chlorine
35	Dissolved Oxygen
36	Ozone
37	Turbidity (requires 02 or 03 power supply)
38	None
Code	Communications
AN	Two 4–20 mA analog outputs
DP	Profibus® DP digital communications
HT	HART® dgital communications
Code	UL Option
	No selection
UL	UL Approval
Example 1056 -03 -02 -32 -UL	

Table 5 - Accessories

Part #	Description
23554-00	1 Cable Gland Kit - Qty 5 per pack
23820-00	2" Pipe Mounting Bracket includes Ubolts, mounting bracket, nuts, washers, and screws (complete). Also accommodates wall / surface mounting.
23820-01	2" Pipe Mounting Bracket, Stainless Steel
9240048-00	S.S. Tag (specify marking)

Engineering Specifications Rosemount 1056 Dual-Input Intelligent Analyzer

Scope of Work

The instrument shall be a linepowered analyzer for measuring pH, ORP, Conductivity, Chlorine, Dissolved and Gaseous Oxygen, Dissolved Ozone, Temperature, Turbidity, Flow, or 4–20 mA current input. The device shall include two isolated inputs, seven local languages, two 4–20 mA current outputs, removable connectors for power and current outputs, four solid plugs for closure of openings, and panel mount hardware. Accessories and services shall be available from the manufacturer of the device to support this instrument and its installation.

The analyzer shall be manufactured by Emerson, 2400 Barranca Parkway, Irvine, CA 926065018 USA 888.854.8257 EmersonProcess.com/LiquidAnalysis, or as approved equal.

General

The analyzer shall be microprocessor-based and accept all Rosemount sensors. The analyzer shall be approved by UL for use in ordinary locations and shall be approved by FM and CSA for use in Class I Division 2 hazardous areas.

Power and Alarms

20–30 VDC and autoswitching 85-265 VAC power supplies shall be available. These power supplies shall each include four high load 5 amp. alarm relays which can be configured independently and which include interval timer functionality. Failsafe operation shall be supported to allow programmable default states for all relays.

Measurement Inputs

The analyzer shall be offered in single and dual input configurations, and shall allow unrestricted dual measurement combinations. Measurement inputs 1 or 2 can be pH, ORP, ISE, Resistivity, Conductivity, Resistivity, % Concentration, Chlorine,

Oxygen, Ozone, Temperature, Turbidity, Flow, or 4–20 mA Current Input. Reconfiguration shall be possible by exchanging modular signal boards for any indicated measurement listed above. Separate signal input measurement boards shall be available to allow field reconfiguration of any 1056 unit.

Measurement	Range	Performance
pH	0–14 pH	±0.01 pH
ORP	-1500 to 1500 mV	±01 mV
Contact Conductivity	0.01 μS/cm–600 mS/cm	±0.6 %
Toroidal Conductivity	1 μS/cm–2000 mS/cm	±1 %
Free Chlorine	0–20 ppm	±1 %
Total Chlorine	0–20 ppm	±1 %
Monochloramine	0–20 ppm	±1 %
Dissolved oxygen	0–20 ppm	±1 %
Dissolved ozone	0–10 ppm	±1 %
Turbidity	0–20 NTU	±2 %
Flow	0–99999 GPM	±1 % ±0.5 %
4–20 mA input	0–20 mA	±0.03 mA

Digital Communications

The instrument shall offer HART® and Profibus® DP as digital communications ordering options. HART and Profibus DP will support all single and dual measurement configurations and will operate with available AC or DC power supplies.

Special Measurements

The analyzer shall measure ammonia and fluoride using commercially available ion-selective electrodes. When the proper chlorine sensor is used, the analyzer shall be capable of measuring free chlorine with automatic correction for

pH. The analyzer shall be able to derive and display pH using two contacting conductivity boards and the appropriate contacting conductivity sensors. With a dual input conductivity configuration, the analyzer shall be capable of measuring differential conductivity and displaying the measurement value as ratio, % rejection, or % passage. Dual flow configurations shall allow % recovery, flow difference, % flow ratio, flow ratio, or totalized difference.

Enclosure and Installation

The analyzer enclosure shall be constructed of polycarbonate and designed to meet NEMA 4X/CSA 4 (IP65) requirements. The instrument fits standard ½ DIN panel cutouts. One enclosure design shall support panel-mount, pipemount, and surface/wallmount installations.

Wiring

The instrument shall ship with removable connectors for power and current outputs. Individual wiring lead designations for each input board shall be labeled to facilitate easy wiring. Further, each signal board shall slide out fully or partially to aid in ease of wiring.

Start-up

Quick Start screens shall appear the first time the instrument is powered up. The instrument shall automatically recognize each measurement board upon power-up.

Outputs

The analyzer shall include two 4–20 mA or 0–20 mA isolated outputs, continuously adjusted, with output dampening and linear or logarithmic output. The outputs shall be independently programmed to correspond to the selected measurement(s) or temperature.

Display and Languages

The analyzer shall have a 58 x 78 mm display with 128 X 96 pixel resolution and backlight. The LCD shall display large process variables (14 mm [½"] character height) for both sensor inputs and allow the user to program the main display with userselectable diagnostic parameters. Seven local languages shall be field selectable including English, French, German, Italian, Spanish, Portuguese, or Chinese. The main display format shall be customizable to meet measurement or diagnostic display requirements.

Automatic Buffer Recognition

For pH measurement, the analyzer shall include an automatic

buffer recognition feature, using stored buffer values and their temperature curves for the most common buffer standards available worldwide. The analyzer shall automatically recognize the value of the buffer being measured and perform a self stabilization check on the sensor before completing the calibration.

Temperature

Manual or automatic temperature compensation shall be menu selectable. Changes in the measurement due to process temperatures shall be compensated using a programmable temperature coefficient except for turbidity, flow and 4–20 mA current input. For pH, temperature compensations shall be standard. Temperature compensation is also available for high purity, dilute base, and custom applications. The analyzer shall automatically recognize either a Pt100 RTD or a Pt1000 RTD, normally built into the sensor. The display of temperature shall be in °C or °F.

Security and Hold

The analyzer shall have two levels of password access to prevent accidental or unwanted changes to the program settings, displays, and calibration. One access code is for calibration and hold of current outputs; the other access code is for all menus and functions. During hold, the outputs and alarms shall remain at the last value.

Diagnostics

The instrument shall have a dedicated DIAGNOSTIC button and the analyzer shall continuously monitor itself and the sensor for faults, and display fault and/or warning messages. Faults and warnings shall be quickly accessible via the dedicated Diagnostic button and help screens shall be displayed to assist in troubleshooting.

Calibration

Depending on the selected measurement, the analyzer shall have several calibration methods.

- a. pH: Automatic buffer, Standardization, and Slope calibration methods
- b. Amperometric: Air cal, Zero cal, In process cal, and Sensitivity/slope entry
- c. Turbidity: Slope cal (2-point), Standard cal (1-point), and Grab cal.

The analyzer shall be a Rosemount 1056 dual-input analyzer, Model number 1056-XX-XX-XX-XX Engineering Specifications 1056 Dual-input Intelligent Analyzer.

(This page purposely left blank for your notes)

EmersonProcess.com/LiquidAnalysis



YouTube.com/user/RosemountAnalytical



Analyticexpert.com



Twitter.com/Rosemount_News



Facebook.com/Rosemount

©2016 Emerson Process Management. All rights reserved.

Emerson Process Management

2400 Barranca Parkway
Irvine, CA 92606
USA

Toll Free + 800 854 8257
T + 949 757 8500
F + 949 474 7250

Liquid.CSC@Emerson.com

The Emerson logo is a trademark and service mark of Emerson Electric Co. All other marks are the property of their respective owners.

The contents of this publication are presented for information purposes only, and while effort has been made to ensure their accuracy, they are not to be construed as warranties or guarantees, express or implied, regarding the products or services described herein or their use or applicability. All sales are governed by our terms and conditions, which are available on request. We reserve the right to modify or improve the designs or specifications of our products at any time without notice.