

Rosemount™ 1066

Smart-Enabled, 2-Wire Transmitter



Essential Instructions

Read this page before proceeding

Emerson designs, manufactures, and tests its Rosemount products to meet many national and international standards. Because these instruments are sophisticated technical products, you must properly install, use, and maintain them to ensure they continue to operate within their normal specifications. The following instructions must be adhered to and integrated into your safety program when installing, using, and maintaining Rosemount products. Failure to follow the proper instructions may cause any one of the following situations to occur: Loss of life; personal injury; property damage; damage to this instrument; and warranty invalidation.

- Read all instructions prior to installing, operating, and servicing the product. If this Instruction Manual is not the correct manual, telephone 1-800-854-8257 and the requested manual will be provided. Save this Instruction Manual for future reference.
- If you do not understand any of the instructions, contact your Emerson representative for clarification.
- Follow all warnings, cautions, and instructions marked on and supplied with the product.
- Inform and educate your personnel in the proper installation, operation, and maintenance of the product.
- Install your equipment as specified in the Installation Instructions of the appropriate Instruction Manual and per applicable local and national codes. Connect all products to the proper electrical and pressure sources.
- To ensure proper performance, use qualified personnel to install, operate, update, program, and maintain the product.
- When replacement parts are required, ensure that qualified people use replacement parts specified by Rosemount. Unauthorized parts and procedures can affect the product's performance and place the safe operation of your process at risk. Look alike substitutions may result in fire, electrical hazards, or improper operation.
- Ensure that all equipment doors are closed and protective covers are in place, except when maintenance is being performed by qualified persons, to prevent electrical shock and personal injury.

WARNING: EXPLOSION HAZARD

DO NOT OPEN WHILE CIRCUIT IS LIVE. ONLY CLEAN WITH DAMP CLOTH.

NOTICE

If a 475 Universal HART® Communicator is used with these transmitters, the software within the 475 may require modification. If a software modification is required, please contact your local Emerson Service Group or National Response Center at 1-800-654-7768.

Electrostatic ignition hazard.

Special condition for safe use (when installed in hazardous area)

1. The plastic enclosure, excepting the front panel, must only be cleaned with a damp cloth. The surface resistivity of the non-metallic enclosure materials is greater than one gigaohm. Care must be taken to avoid electrostatic charge build-up. The 1066 Transmitter must not be rubbed or cleaned with solvents or a dry cloth.
2. The panel mount gasket has not been tested for type of protection IP66 or Class II and III. Type of protection IP66 and Class II, III refer the enclosure only.

3. The surface resistivity of the non-metallic enclosure materials is greater than one gigaohm. Care must be taken to avoid electrostatic charge build-up. The Model 1066 Transmitter must not be rubbed or cleaned with solvents or a dry cloth.
4. Special Condition of Use of 1066 C FF/FII5 and 1066T FF/FII5. For use with simple apparatus model series 140, 141, 142, 150, 400, 401, 402, 402VP, 403, 403VP, 404, and 410VP contacting conductivity sensors and model series 222, 225, 226, 228 toroidal sensors.

About this document

This manual contains instructions for installation and operation of the 1066 Smart Transmitter. The following list provides notes concerning all revisions of this document.

Rev. Level	Date	Notes
A	1/2012	This is the initial release of the product manual. The manual has been reformatted to reflect the Emerson documentation style and updated to reflect any changes in the product offering.
B	3/2012	This product manual version adds specifications and instrument instructions for Contacting Conductivity, Toroidal Conductivity, Chlorine, Oxygen, and Ozone measurements.
C	9/2012	This product manual version adds FM agency approval.
D	3/2013	Updated CSA Intrinsically Safe Installation drawings.
E	7/2013	Updated CSA test Standards and Intrinsically Safe installation drawings and update CE certificates. Added FM temperature specifications to Non-Incendive Hazardous Location Approval.
F	9/2013	Added Section 10: HART® Communications
G	11/2014	Changed agency water exposure testing description to "Type".
H	05/2015	FM approvals updated.
J	04/2017	Updated the Address and Emerson logo. Also, updated the FM, CSA installation drawings and CE Declarations.

Contents

Section 1: Quick Start Guide

1.1	Quick start guide	1
-----	-------------------------	---

Section 2: Description and Specifications

2.1	Features and Applications	3
2.2	Specifications - General	4
2.3	pH/ORP	4
2.3.1	Performance Specifications - Transmitter (pH input)	6
2.3.2	Performance Specifications - Transmitter (ORP input)	6
2.4	Contacting Conductivity (Codes - C)	7
2.4.1	Performance Specifications	7
2.4.2	Recommended Sensors for Conductivity	8
2.5	Toroidal Conductivity (Codes - T)	8
2.5.1	Performance Specifications	8
2.5.2	Recommended Sensors for Conductivity	9
2.6	Chlorine (Codes - L).....	9
2.6.1	Free and Total Chlorine	9
2.6.2	Performance Specifications	9
2.6.3	Recommended Sensors	9
2.6.4	Monochloramine	9
2.6.5	Performance Specifications	10
2.6.6	Recommended Sensors	10
2.7	Dissolved Oxygen (Codes - DO)	10
2.7.1	Performance Specification	10
2.7.2	Recommended Sensors	10
2.8	Dissolved Oxygen (Codes - DO).....	10
2.8.1	Performance Specification	10
2.8.2	Recommended Sensors	10
2.9	Ordering Information	11

Section 3: Installation

3.1	Unpacking and Inspection	13
3.2	Installation – General Information	13
3.3	Preparing Conduit Openings	13

Section 4: Wiring

4.1	General	17
4.1.1	General Information	17
4.1.2	Digital Communication	17
4.2	Power Supply/Current Loop – 1066 HT	17

4.2.1	Power Supply and Load Requirements	17
4.2.2	Power Supply-Current Loop Wiring	18
4.2.3	Current Output Wiring	19
4.3	Power Supply Wiring For 1066 FF	20
4.3.1	Power Supply Wiring	20
4.4	Sensor Wiring to Main Board	21

Section 5: Intrinsically Safe Installation

5.1	All Intrinsically Safe Installations	27
-----	--	----

Section 6: Display and operation

6.1	User Interface	33
6.2	Instrument Keypad.....	33
6.3	Main Display	34
6.4	Menu System.....	35

Section 7: Programming – Basics

7.1	General.....	37
7.2	Changing the Startup Settings	37
7.2.1	Purpose	37
7.2.2	Procedure.....	38
7.3	Choosing Temperature Units and Automatic/Manual Temperature Compensation ..	38
7.3.1	Purpose	38
7.4	Configuring and Ranging Current Outputs	38
7.4.1	Purpose	38
7.4.2	Definitions.....	38
7.4.3	Procedure: Configure Outputs	38
7.4.4	Procedure: Ranging the Current Outputs.....	38
7.5	Setting a Security Code	38
7.5.1	Purpose	39
7.5.2	Procedure.....	39
7.6	Security Access.....	40
7.6.1	How the Security Code Works.....	40
7.6.2	Procedure.....	40
7.7	Using Hold.....	40
7.7.1	Purpose	40
7.7.2	Using the Hold Function.....	40
7.8	Resetting Factory Default Settings	41
7.8.1	Purpose	41
7.8.2	Procedure.....	41

Section 8: Programming – Measurements

8.1	Introduction	44
-----	--------------------	----

8.2	pH Measurement Programming	44
8.2.1	Description	44
8.2.2	Measurement	44
8.2.3	Preamp	44
8.2.4	Solution Temperature Correction	45
8.2.5	Temperature Coefficient	45
8.2.6	Resolution	45
8.2.7	Filter	45
8.2.8	Reference Impedance	45
8.3	ORP Measurement Programming	45
8.3.1	Measurement	46
8.3.2	Preamp	46
8.3.3	Filter	46
8.3.4	Reference Impedance	46
8.4	Contacting Conductivity	47
8.4.1	Description	47
8.4.2	Sensor Type	47
8.4.3	Measure	48
8.4.4	Range	48
8.4.5	Cell Constant	48
8.4.6	RTD Offset	48
8.4.7	RTD Slope	48
8.4.8	Temp Comp	48
8.4.9	Slope	49
8.4.10	Reference Temp	49
8.4.11	Filter	49
8.4.12	Custom Setup	49
8.4.13	Cal Factor	49
8.5	Toroidal Conductivity Measurement Programming	50
8.5.1	Description	50
8.5.2	Sensor Type	50
8.5.3	Measure	51
8.5.4	Range	51
8.5.5	Cell Constant	51
8.5.6	Temp Comp	51
8.5.7	Slope	52
8.5.8	Reference Temp	52
8.5.9	Filter	52
8.5.10	Custom Setup	52
8.6	Chlorine Measurement Programming	53
8.6.1	Free Chlorine Measurement Programming	53
8.6.1.1	Measure	54
8.6.1.2	Units	54

8.6.1.3	Filter.....	54
8.6.1.4	Free Chlorine pH Correction	54
8.6.1.5	Manual pH Correction	54
8.6.1.6	Resolution.....	54
8.6.2	Total Chlorine Measurement Programming.....	55
8.6.2.1	Description	55
8.6.2.2	Measure.....	55
8.6.2.3	Units	55
8.6.2.4	Filter.....	55
8.6.2.5	Resolution.....	55
8.6.3	Monochloramine Measurement Programming	56
8.6.3.1	Measure: Monochloramine.....	56
8.6.3.2	Units	56
8.6.3.3	Filter.....	57
8.6.3.4	Resolution.....	57
8.7	Oxygen Measurement Programming.....	57
8.7.1	Oxygen Measurement Application	58
8.7.2	Units	58
8.7.3	Partial Press.....	58
8.7.4	Salinity.....	58
8.7.5	Filter.....	58
8.7.6	Pressure Units	58
8.8	Ozone Measurement Programming.....	59
8.8.1	Units	59
8.8.2	Filter.....	59
8.8.3	Resolution.....	59

Section 9: Calibration

9.1	Introduction	67
9.2	Calibration.....	67
9.2.1	Auto Calibration	68
9.2.2	Manual Calibration – pH.....	68
9.2.3	Entering a Known Slope Value – pH	68
9.2.4	Standardization – pH.....	69
9.2.5	SMART sensor auto calibration upload – pH.....	69
9.3	ORP and Redox Calibration.....	70
9.4	Contacting Conductivity Calibration.....	71
9.4.1	Entering the Cell Constant.....	72
9.4.2	Zeroing the Instrument	72
9.4.3	Calibrating the Sensor in a Conductivity Standard (in process cal)	72
9.4.4	Calibrating the Sensor To A Laboratory Instrument (meter cal)	73
9.4.5	Cal Factor	73

9.5	Toroidal Conductivity Calibration	74
9.5.1	Entering the Cell Constant	74
9.5.2	Zeroing the Instrument	75
9.5.3	Calibrating the Sensor in a Conductivity Standard (in process cal)	75
9.6	Calibration – Chlorine	76
9.6.1	Calibration – Free Chlorine	76
9.6.1.1	Zeroing the Sensor	77
9.6.1.2	In Process Calibration	77
9.6.2	Calibration – Total Chlorine	77
9.6.2.1	Zeroing the Sensor	78
9.6.2.2	In Process Calibration	78
9.6.3	Calibration – Monochloramine	79
9.6.4	Zeroing the Sensor	80
9.6.5	In Process Calibration	80
9.7	Calibration – Oxygen	80
9.7.1	Zeroing the Sensor	82
9.7.2	Calibrating the Sensor in Air	82
9.7.3	Calibrating the Sensor Against A Standard Instrument (in process cal)	83
9.8	Calibration – Ozone	83
9.8.1	Zeroing the Sensor	84
9.8.2	In Process Calibration	84
9.9	Calibrating Temperature	85
9.9.1	Calibration	85

Section 10: HART® Communications

10.1	Introduction	93
10.2	Physical Installation and Configuration	94
10.3	Measurements Available via HART	96
10.4	Diagnostics Available via HART	96
10.5	HART Hosts	97
10.6	Wireless Communication using the 1066	100
10.7	Field Device Specification (FDS)	100
APPENDIX 10.1	Device Variables	101
APPENDIX 10.2	Additional Transmitter Status – Command 48 Status Bits	103
APPENDIX 10.3	1066 HART Configuration Parameters	108
APPENDIX 10.4	475 Menu Tree for 1066 HART 7	115

Section 11: Return of Material

11.1	General	121
11.2	Warranty Repair	121
11.3	Non-Warranty Repair	121
	EC Declarations of Conformity	123

Section 1: Quick Start Guide

1.1

1. For mechanical installation instructions, see [page 14](#) for panel mounting and [page 15](#) for pipe or wall mounting.
2. Wire the sensor to the main circuit board. See [pages 21-23](#) for wiring instructions. Refer to the sensor instruction sheet for additional details. Make loop power connections.
3. Once connections are secured and verified, apply DC power to the transmitter.
4. When the transmitter is powered up for the first time, Quick Start screens appear. Quick Start operating tips are as follows:
 - a. A highlighted field shows the position of the cursor.
 - b. To move the cursor left or right, use the keys to the left or right of the ENTER key. To scroll up or down or to increase or decrease the value of a digit use the keys above and below the ENTER key. Use the left or right keys to move the decimal point.
 - c. Press ENTER to store a setting. Press EXIT to leave without storing changes. Pressing EXIT during Quick Start returns the display to the initial start-up screen (select language).
5. Choose the desired language and press ENTER.
6. Choose measurement and press ENTER.
 - a. For pH, choose preamplifier location. Select Analyzer to use the integral preamplifier in the transmitter; select Sensor/J-Box if your sensor is SMART or has an integral preamplifier or if you are using a remote preamplifier located in a junction box.
5. If applicable, choose units of measurement.
6. For contacting and toroidal conductivity, choose the sensors type and enter the numeric cell constant using the keys.
7. Choose temperature units: °C or °F.
8. After the last step, the main display appears. The outputs are assigned to default values.
9. To change output settings, to scale the 4-20 mA current outputs, to change measurement-related settings from the default values, and to enable pH diagnostics, press MENU. Select Program and follow the prompts. Refer to the appropriate menu.
10. To return the transmitter to the factory default settings, choose Program under the main menu, and then scroll to Reset.
11. Please call the Rosemount Customer Support Center at 1-800-854-8257 if you need further support.

Section 2: Description and Specifications

2.1 Features and Applications

This loop-powered multi-parameter unit serves industrial, commercial and municipal applications with the widest range of liquid measurement inputs available for a two-wire liquid transmitter.

The 1066 Smart transmitter supports continuous measurement of one liquid analytical input. The design supports easy internal access and wiring connections.

Analytical Inputs: Ordering options for pH/ORP, Resistivity/Conductivity, % Concentration, Total Chlorine, Free Chlorine, Monochloramine, Dissolved Oxygen, and Ozone.

Large Display: The high-contrast LCD provides live measurement readouts in large digits and shows up to four additional variables or diagnostic parameters.

Digital Communications: HART 7 and FOUNDATION Fieldbus options.

Menus: Menu screens for calibrating and programming are simple and intuitive. Plain language prompts and help screens guide the user through the procedures. All menu screens are available in eight languages. Live process values are displayed during programming and calibration.

Quick Start Programming: Popular Quick Start screens appear the first time the unit is powered. The instrument prompts the user to configure the sensor loop in a few quick steps for immediate commissioning.

User Help Screens: Fault and warning messages include help screens similar to PlantWeb™ alerts that provide useful troubleshooting tips to the user. These on-screen instructions are intuitive and easy to use.

Diagnostics: The transmitter continuously monitors itself and the sensor for problems. A display banner on the screen alerts Technicians to Fault and/or Warning conditions.

Languages: Emerson extends its worldwide reach by offering eight languages – English, French, German, Italian, Spanish, Portuguese, Chinese and Russian.

Current Outputs: HART units include two 4-20 mA electrically isolated current outputs giving the ability to transmit the live measurement value and the process temperature reported from the sensor.

Input Dampening: is automatically enabled to suppress noisy process readings.

Smart-Enabled pH: Rosemount SMART pH capability eliminates field calibration of pH probes through automatic upload of calibration data and history.

Automatic Temperature Compensation: Most measurements require temperature compensation. The 1066 will automatically recognize Pt100, Pt1000 or 22k NTC RTDs built into the sensor.

Smart Wireless Thum Adaptor Compatible: Enable wireless transmissions of process variables and diagnostics from hard-to-reach locations.

2.2 Specifications - General

Case: Polycarbonate. IP66 (CSA, FM), Type 4X (CSA)

Dimensions: Overall 155 x 155 x 131mm (6.10 x 6.10 x 5.15 in.). Cutout: 1/2 DIN 139mm x 139mm (5.45 x 5.45 in.)

Conduit openings: Six. Accepts PG13.5 or 1/2 in. conduit fittings

Display: Monochromatic graphic liquid crystal display. No backlight. 128 x 96 pixel display resolution. Active display area: 58 x 78mm (2.3 x 3.0 in.). All fields of the main instrument display can be customized to meet user requirements.

Ambient temperature and humidity: -20 to 65 °C (-4 to 149°F), RH 5 to 95% (non-condensing).

Storage Temperature: -20 to 70 °F (-4 to 158 °F)

HART® Communications: PV, SV, TV, and 4V assignable to measurement, temperature and all live HART diagnostics.

RFI/EMI: EN-61326-1 C E

Complies with the following Standards:

CSA: C22.2 No 0 – 10; C22.2 No 0.4 – 04; C22.2 No. 25-M1966: , C22.2 No. 94-M91: , C22.2 No.142-M1987: , C22.2 No. 157-M1992: , C22.2 No. 213-M1987: , C22.2 No. 60529:05. UL: 50:11th Ed.; 508:17th Ed.; 913:7th Ed.; 1203:4th Ed.. ANSI/ISA: 12.12.10-2013.

ATEX: EN 60079-0:2012+A11:2013, 60079-11:2012

IECEX: IEC 60079-0: 2011 Edition: 6.0, I EC 60079-11 : 2011-06 Edition: 6.0

FM: 3600: 2011, 3610: 2010, 3611: 2004, 3810: 2005, IEC 60529:2004, ANSI/ISA 60079-0: 2009, ANSI/ISA 60079-11: 2009

Hazardous Location Approvals

Intrinsic Safety (with appropriate safety barrier):



Class I, II, III, Div. 1*
Groups A-G
T4 Tamb = -20 °C to 65 °C
Enclosure 4X, IP66
For Intrinsically Safe Installation,
see drawing 1400669



IECEX BAS 11.0098X
Ex ia IIC T4 Ga
T4 Tamb = -20 °C to 65 °C



ATEX
CE 1180 II 1 G
Baseefa11ATEX0195X
Ex ia IIC T4 Ga
T4 Tamb = -20 °C to 65 °C



Class I, II & III, Division 1, Groups A-G T4
Tamb = -20 °C to 65 °C
IP66 enclosure
Class I, Zone 0, AEx ia IIC T4
Tamb = -20°C to 65°C
For Intrinsically Safe Installation, see drawing 1400670

Non-Incendive:



Class I, Div. 2, Groups A-D*
Dust Ignition Proof Class II & III, Div 1, Groups EFG
Class II & III, Div. 1, Groups E-G
Type 4/4X Enclosure
T4 Tamb = -20 °C to 65 °C
For Non-Incendive Field Wiring Installation, see drawing 1400669



Class I, Division 2 Groups A-D
Dust Ignition proof Class II & III, Div 1, Groups EFG
Class II & III, Division 1, Groups E-G
Tamb = -20°C to 65°C, IP66 enclosure
For Non-Incendive Field Wiring Installation, see drawing 1400670

* Additionally approved as a system with models 140,141,142, 150, 400, 400VP, 401, 402, 402VP, 403,403VP, 404 & 410VP contacting conductivity sensors and models 222, 225, 226 & 228 inductive conductivity sensors.

Input: One isolated sensor input. Measurement choices of pH/ORP, resistivity/conductivity/TDS, % concentration, total and free chlorine, monochloramine, dissolved oxygen, dissolved ozone, and temperature. For contacting conductivity measurements, temperature element can be a PT1000 RTD or a PT100 RTD. Other measurements (except ORP) and use PT100 or PT1000 RTDs or a 22k NTC (D.O. only).

Power and Load Requirements: Supply voltage at the transmitter terminals should be at least 12.7 Vdc. Power supply voltage should cover the voltage drop on the cable plus the external load resistor required for HART communications (250 Ω minimum). Minimum power supply voltage is 12.7 Vdc. Maximum power supply voltage is 42.4 Vdc (30 Vdc for intrinsically safe operation). The graph shows the supply voltage required to maintain 12 Vdc (upper line) and 30 Vdc (lower line) at the transmitter terminals when the current is 22 mA.

FIGURE 2-1. Load/Power Supply Requirements

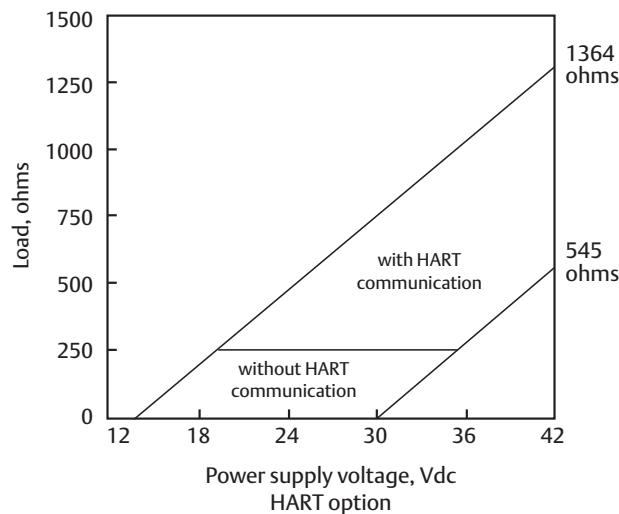

Analog Outputs: Two-wire loop powered (Output 1 only). Two 4-20 mA electrically isolated current outputs (Output 2 must be externally powered). Superimposed HART digital signal on Output 1. Fully scalable over the operating range of the sensor.

Weight/Shipping Weight: 2 lbs/3 lbs (1 kg/1.5 kg)

2.3 pH/ORP (Codes – P)

For use with any standard pH or ORP sensor. SMART pH sensor with SMART pre-amplifiers from Rosemount. Measurement choices are pH, ORP, or Redox. The automatic buffer recognition feature uses stored buffer values and their temperature curves for the most common buffer standards available worldwide. The transmitter will recognize the value of the buffer being measured and perform a self stabilization check on the sensor before completing the calibration. Manual or automatic temperature compensation is menu selectable. Change in pH due to process temperature can be compensated using a programmable temperature coefficient.

2.3.1 Performance Specifications - Transmitter (pH input)

Measurement Range [pH]: 0 to 14 pH

Accuracy: ± 0.01 pH

Buffer recognition: NIST, DIN 19266, JIS 8802, and BSI.

Input filter: Time constant 1 - 999 sec, default 4 sec.

Response time: 5 seconds to 95% of final reading

Recommended Sensors for pH:

All standard pH sensors. Supports SMART pH sensors from Rosemount.

2.3.2 Performance Specifications - Transmitter (ORP input)

Measurement Range [ORP]: -1400 to +1400 mV

Accuracy: ± 1 mV

Input filter: Time constant 1 - 999 sec, default 4 sec.

Response time: 5 seconds to 95% of final reading

Recommended Sensors for ORP: All standard ORP sensors

FIGURE 2-2. General purpose and high performance pH sensors 3900, 396PVP and 3300HT



2.4 Contacting Conductivity (Codes – C)

Measures conductivity in the range 0 to 600,000 $\mu\text{S}/\text{cm}$ (600mS/cm). Measurement choices are conductivity, resistivity, total dissolved solids, salinity, and % concentration. In addition, the “Custom Curve” feature allows users to define a three to five point curve to measure ppm, %, or a no unit variable. The % concentration selection includes the choice of five common solutions (0-12% NaOH, 0-15% HCl, 0-20% NaCl, and 0-25% or 96-99.7% H_2SO_4). The conductivity concentration algorithms for these solutions are fully temperature compensated. Three temperature compensation options are available: manual slope ($X\% / ^\circ\text{C}$), high purity water (dilute sodium chloride), and cation conductivity (dilute hydrochloric acid). Temperature compensation can be disabled, allowing the transmitter to display raw conductivity. For more information concerning the use of the contacting conductivity sensors, refer to the product data sheets.

Note: The 410VP 4-electrode high-range conductivity sensor is compatible with the 1066.

2.4.1 Performance Specifications

Temperature specifications:

Temperature range	0-200 °C
Temperature Accuracy, Pt-1000, 0-50 °C	± 0.1 °C
Temperature Accuracy, Pt-1000, Temp. > 50 °C	± 0.5 °C

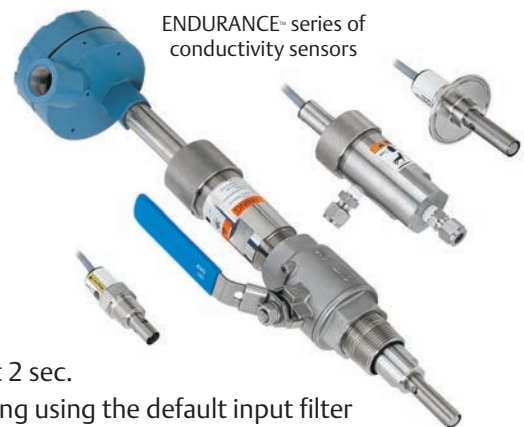

Input filter: Time constant 1 - 999 sec, default 2 sec.

Response time: 3 seconds to 95% of final reading using the default input filter

Salinity: Uses Practical Salinity Scale

Total Dissolved Solids: Calculated by multiplying conductivity at 25 °C by 0.65

Table 2-1. Performance Specifications: Recommended Range – Contacting Conductivity

Cell Constant	0.01S/cm	0.1 $\mu\text{S}/\text{cm}$	1.0 $\mu\text{S}/\text{cm}$	10 $\mu\text{S}/\text{cm}$	100 $\mu\text{S}/\text{cm}$	1000 $\mu\text{S}/\text{cm}$	10mS/cm	100mS/cm	1000mS/cm
0.01	0.01 $\mu\text{S}/\text{cm}$ to 200 $\mu\text{S}/\text{cm}$		200 $\mu\text{S}/\text{cm}$ to 2000 $\mu\text{S}/\text{cm}$						
0.1	0.1 $\mu\text{S}/\text{cm}$ to 2000 $\mu\text{S}/\text{cm}$			2000 $\mu\text{S}/\text{cm}$ to 20mS/cm					
1.0	1 $\mu\text{S}/\text{cm}$ to 20mS/cm		20mS/cm to 200mS/cm						
4-electrode									2 $\mu\text{S}/\text{cm}$ to 1400mS/cm

Linearity for Standard Cable ≤ 50 ft (15 m)

- $\pm 0.6\%$ of reading in recommended range
- - - - - $\pm 2\%$ of reading outside high recommended range
- $\pm 5\%$ of reading outside low recommended range
- ■ - ■ - ■ $\pm 4\%$ of reading in recommended range

2.4.2 Recommended Sensors for Conductivity

All Rosemount 400 series conductivity sensors (Pt 1000 RTD) and 410VP 4-electrode sensor.

2.5 Toroidal Conductivity (Codes – T)

Measures conductivity in the range of 1 $\mu\text{S}/\text{cm}$ to 2,000,000 $\mu\text{S}/\text{cm}$ (2 S/cm). Measurement choices are conductivity, resistivity, total dissolved solids, salinity, and % concentration. The % concentration selection includes the choice of five common solutions (0-12% NaOH, 0-15% HCl, 0-20% NaCl, and 0-25% or 96-99.7% H_2SO_4). The conductivity concentration algorithms for these solutions are fully temperature compensated. For other solutions, a simple-to-use menu allows the customer to enter his own data. The transmitter accepts as many as five data points and fits either a linear (two points) or a quadratic function (three to five points) to the data. Reference temperature and linear temperature slope may also be adjusted for optimum results. Two temperature compensation options are available: manual slope (X% / $^{\circ}\text{C}$) and neutral salt (dilute sodium chloride). Temperature compensation can be disabled, allowing the transmitter to display raw conductivity. For more information concerning use of the toroidal conductivity sensors, refer to the product data sheets.

2.5.1 Performance Specifications

Temperature specifications:

Temperature range	-25 to 210 $^{\circ}\text{C}$ (-13 to 410 $^{\circ}\text{F}$)
Temperature Accuracy, Pt-100, -25 to 50 $^{\circ}\text{C}$	± 0.5 $^{\circ}\text{C}$
Temperature Accuracy, Pt-100, 50 to 210 $^{\circ}\text{C}$	± 1 $^{\circ}\text{C}$

High performance 225 Toroidal & 226 Conductivity sensors



Repeat

$\mu\text{S}/\text{cm}$ after

TABLE 2-2. Performance Specifications: Recommended Range – Toroidal Conductivity

Model	1 $\mu\text{S}/\text{cm}$	10 $\mu\text{S}/\text{cm}$	100 $\mu\text{S}/\text{cm}$	1000 $\mu\text{S}/\text{cm}$	10 mS/cm	100 mS/cm	1000 mS/cm	2000 mS/cm
226			50 $\mu\text{S}/\text{cm}$ to 500 mS/cm				500 mS/cm to 2000 mS/cm	
225 & 228			50 $\mu\text{S}/\text{cm}$ to 1500 mS/cm				1500 mS/cm to 2000 mS/cm	
242			100 $\mu\text{S}/\text{cm}$ to 2000 mS/cm					
222 (1in & 2in)			500 $\mu\text{S}/\text{cm}$ to 2000 mS/cm					

Loop Performance (Following Calibration)

- 226: $\pm 1\%$ of reading $\pm 5 \mu\text{S}/\text{cm}$ in recommended range
- 225 & 228: $\pm 1\%$ of reading $\pm 15 \mu\text{S}/\text{cm}$ in recommended range
- 222, 242: $\pm 4\%$ of reading $\pm 5 \text{mS}/\text{cm}$ in recommended range
- - - - - 225, 226 & 228: $\pm 5\%$ of reading outside high recommended range

zero cal

Input filter: time constant 1 - 999 sec, default 2 sec.

Response time: 3 seconds to 95% of final reading

Salinity: Uses Practical Salinity Scale

Total Dissolved Solids: Calculated by multiplying conductivity at 25 °C by 0.65

2.5.2 Recommended Sensors for Conductivity

All Rosemount submersion/immersion and flow-through toroidal sensors.

2.6 Chlorine (Codes – CL)

2.6.1 Free and Total Chlorine

The 1066 is compatible with the 499ACL-01 free chlorine sensor and the 499ACL-02 total chlorine sensor. The 499ACL-02 sensor must be used with the TCL total chlorine sample conditioning system. The 1066 fully compensates free and total chlorine readings for changes in membrane permeability caused by temperature changes. For free chlorine measurements, both automatic and manual pH correction are available. For automatic pH correction select an appropriate pH sensor. For more information concerning the use and operation of the amperometric chlorine sensors and the TCL measurement system, refer to the product data sheets.

2.6.2 Performance Specifications

Resolution: 0.001 ppm or 0.01 ppm – selectable

Input Range: 0nA – 100 μ A

Automatic pH correction for Free Chlorine: (user selectable for code -CL): 6.0 to 10.0 pH

Temperature compensation: Automatic (via RTD) or manual (0-50 °C).

Input filter: Time constant 1 - 999 sec, default 5 sec.

Response time: 6 seconds to 95% of final reading



499ACL-01
Chlorine sensor

2.6.3 Recommended Sensors

Chlorine: 499ACL-01 Free Chlorine or 499ACL-0₂ Total Residual Chlorine

pH: These pH sensors are recommended for automatic pH correction of free chlorine readings: 3900-02-10, 3900-01-10, and 3900VP-02-10.

2.6.4 Monochloramine

The 1066 is compatible with the 499A CL-03 Monochloramine sensor. The 1066 fully compensates readings for changes in membrane permeability caused by temperature changes. Because monochloramine measurement is not affected by pH of the process, no pH sensor or correction is required. For more information concerning the use and operation of the amperometric chlorine sensors, refer to the product data sheets.

2.6.5 Performance Specifications

Resolution: 0.001 ppm or 0.01 ppm – selectable

Input Range: 0nA – 100 μ A

Temperature compensation: Automatic (via RTD) or manual (0-50 °C).

Input filter: Time constant 1 - 999 sec, default 5 sec.

Response time: 6 seconds to 95% of final reading

2.6.6 Recommended Sensors

Rosemount 499ACL-03 Monochloramine sensor

2.7 Dissolved Oxygen (Codes –DO)

The 1066 is compatible with the 499ADO, 499ATrDO, Hx438, Gx438 and Bx438 dissolved oxygen sensors and the 4000 percent oxygen gas sensor. The 1066 displays dissolved oxygen in ppm, mg/L, ppb, μ g/L, % saturation, % O₂ in gas, ppm O₂ in gas. The transmitter fully compensates oxygen readings for changes in membrane permeability caused by temperature changes. Automatic air calibration, including salinity correction, is standard. The only required user entry is barometric pressure. For more information on the use of amperometric oxygen sensors, refer to the product data sheets.

2.7.1 Performance Specifications

Resolution: 0.01 ppm; 0.1 ppb for 499A TrDO sensor (when O₂ < 1.00 ppm); 0.1%

Input Range: 0nA – 100 μ A

Temperature Compensation: Automatic (via RTD) or manual (0-50 °C).

Input filter: Time constant 1 - 999 sec, default 5 sec.

Response time: 6 seconds to 95% of final reading



Dissolved Oxygen
499ADO sensor with
Variopool connection

2.7.2 Recommended Sensors

Rosemount amperometric membrane and steam-sterilizable sensors listed above

2.8 Ozone (Codes –OZ)

The 1066 is compatible with the 499AOZ sensor. The 1066 fully compensates ozone readings for changes in membrane permeability caused by temperature changes. For more information concerning the use and operation of the amperometric ozone sensors, refer to the product data sheets.

2.8.1 Performance Specifications

Resolution: 0.001 ppm or 0.01 ppm – selectable

Input Range: 0nA – 100 μ A

Temperature Compensation: Automatic (via RTD) or manual (0-35 °C)

Input filter: Time constant 1 - 999 sec, default 5 sec.

Response time: 6 seconds to 95% of final reading



Dissolved Ozone
499AOZ sensors with
Variopool connection

2.8.2 Recommended Sensors

Rosemount 499A OZ ozone sensor

2.9 Ordering Information

The 1066 2-Wire Transmitter is intended for the continuous determination of pH, ORP (Redox), conductivity, (both contacting and toroidal), and for measurements using membrane-covered amperometric sensors (oxygen, ozone, free and total chlorine, and monochloramine). For free chlorine measurements, which often require continuous pH correction a second input for a pH sensor is available. Two 4-20mA analog outputs are standard on HART units. The 1066 is compatible with SMART pH sensors from Rosemount. HART digital communications is standard and FOUNDATION® fieldbus digital communication is offered as an option.

Communication with the 1066 is through:

- Local keypad interface
- 475 HART® and FOUNDATION fieldbus Communicator
- HART protocol version 7
- FOUNDATION fieldbus
- AMS (Asset Management Solutions) Aware
- SMART Wireless THUM™ Adapter

TABLE 2-3. Ordering Information

Description	
1066 pH/ORP, Conductivity, Chlorine, Oxygen, and Ozone 2-Wire Transmitter	
Measurement	
P	pH/ORP
C	Contacting Conductivity
T	Toroidal Conductivity
CL	Chlorine
DO	Dissolved Oxygen
OZ	Ozone
Communication	
HT	HART® Digital Communication Superimposed on 4-20mA Output
FF	FOUNDATION™ fieldbus Digital Output
FI	FOUNDATION™ fieldbus Digital Output with FISCO
Agency Approval	
60	None Required
67	FM Approved, Intrinsically Safe (appropriate sensor & safety barrier required), and Non-Incendive
69	CSA Approved , Intrinsically Safe (appropriate sensor & safety barrier required), and Non-Incendive
73	ATEX/IECEX Approved, Intrinsically Safe (safety barrier required)

Section 3: Installation

3.1 Unpacking and inspection

Inspect the shipping container. If it is damaged, contact the shipper immediately for instructions. Save the box. If there is no apparent damage, unpack the container. Be sure all items shown on the packing list are present. If items are missing, notify Rosemount immediately.

3.2 Installation – General Information

1. Although the transmitter is suitable for outdoor use, installation in direct sunlight or in areas of extreme temperatures is not recommended unless a sunshield is used.
2. Install the transmitter in an area where vibration and electromagnetic and radio frequency interference are minimized or absent.
3. Keep the transmitter and sensor wiring at least one foot from high voltage conductors. Be sure there is easy access to the transmitter.
4. The transmitter is suitable for panel, pipe, or surface mounting.
5. The transmitter case has six 1/2-inch (PG13.5) conduit openings. Use separate conduit openings for the power/output cable, the sensor cable, and the other the sensor cable as needed (pH input for free chlorine with continuous pH correction).
6. Use weathertight cable glands to keep moisture out to the transmitter. If conduit is used, plug and seal the connections at the transmitter housing to prevent moisture from getting inside the instrument.

3.3 Preparing Conduit Openings

There are six conduit openings in all configurations of 1066.

Conduit openings accept 1/2-inch conduit fittings or PG13.5 cable glands. To keep the case watertight, block unused openings with Type 4X or IP66 conduit plugs.

To maintain ingress protection for outdoor use, seal unused conduit holes with suitable conduit plugs.

NOTE: Use watertight fittings and hubs that comply with your requirements. Connect the conduit hub to the conduit before attaching the fitting to the transmitter.

Electrical installation must be in accordance with the National Electrical Code (ANSI/NFPA-70) and/or any other applicable national or local codes.

FIGURE 3-1. Panel Mounting Dimensions

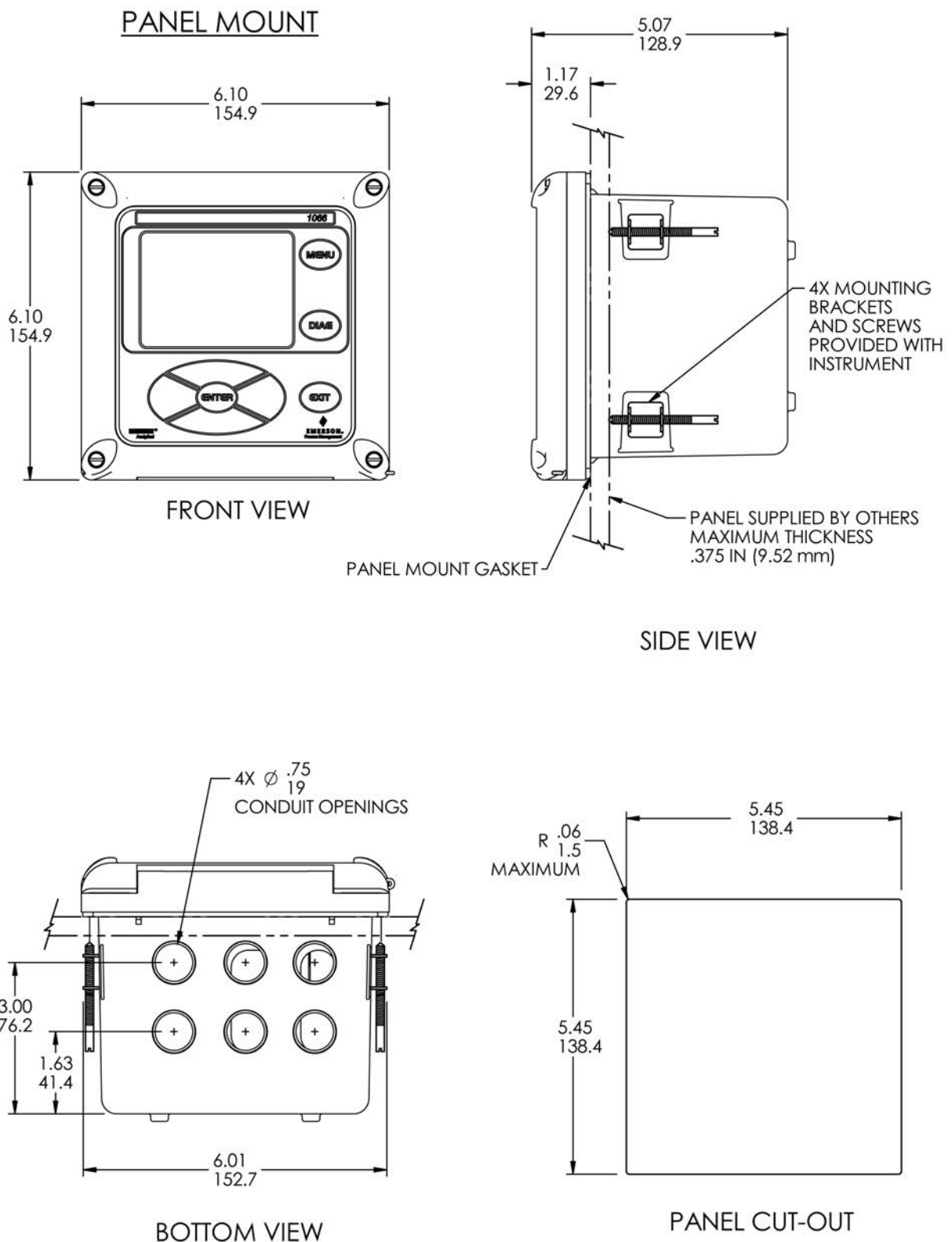
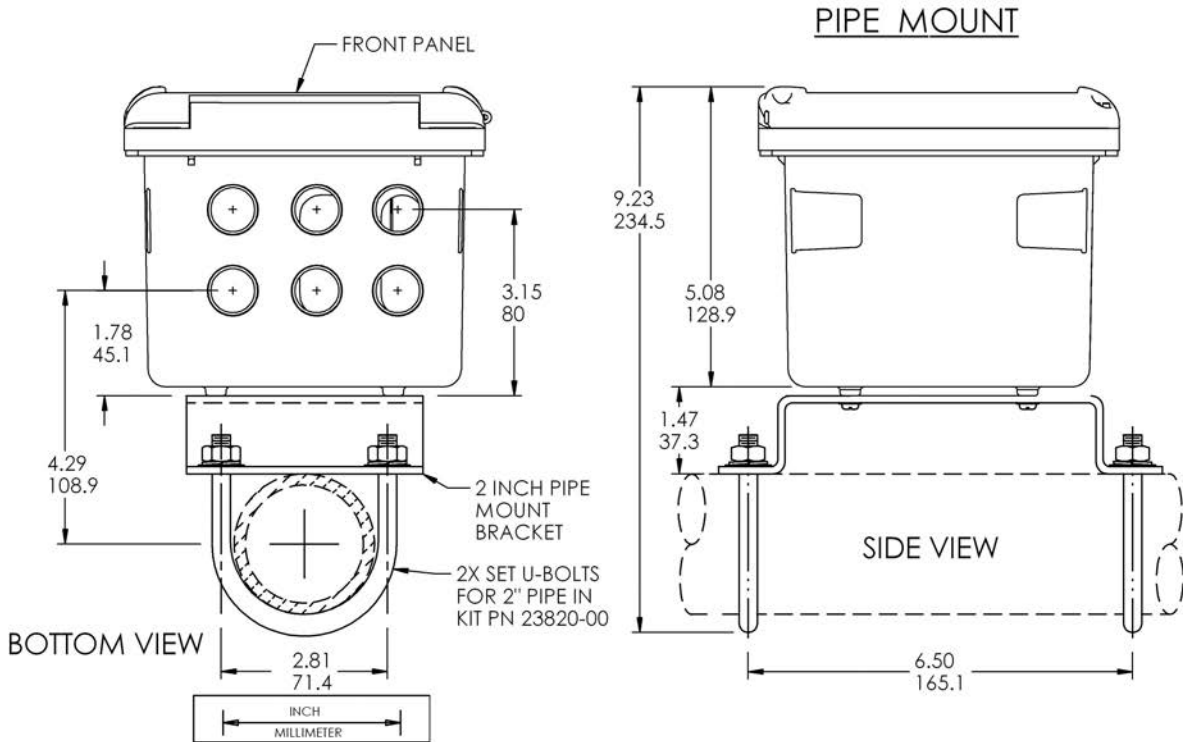
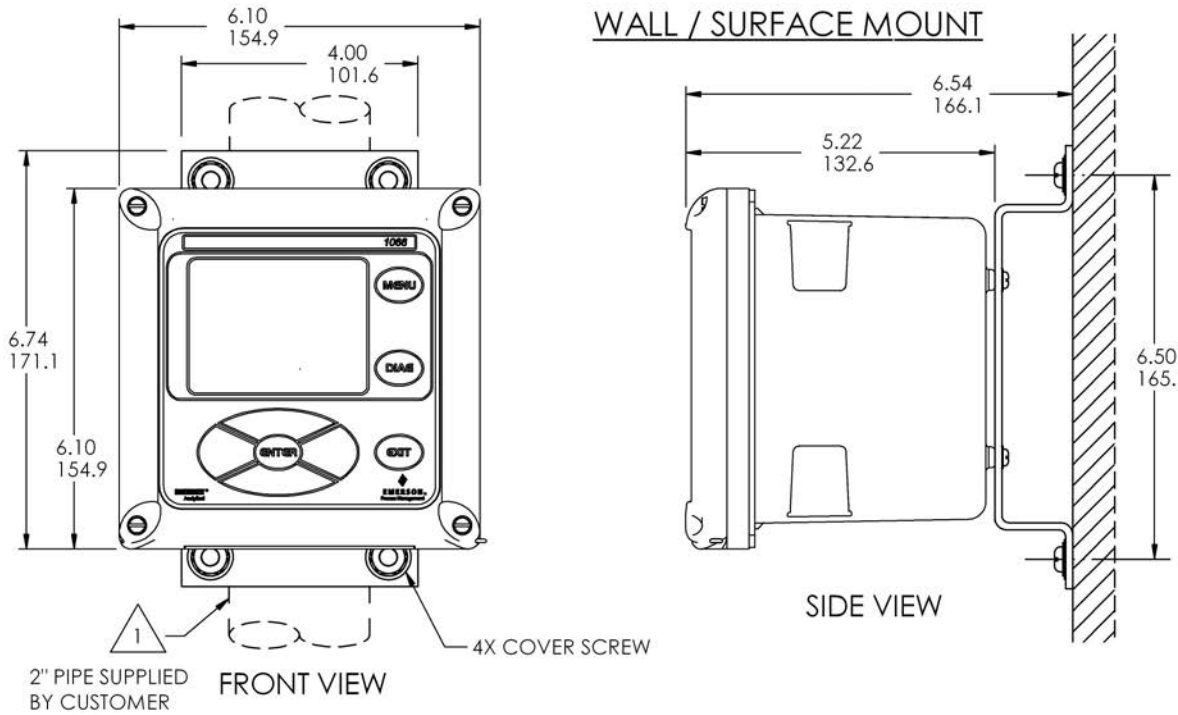

FIGURE 3-2. Pipe and wall mounting dimensions (Mounting bracket PN: 23820-00)



MODEL 1066 W/2" PIPE
MOUNTING BRACKET /WALL
MOUNTING DIMENSIONS
DWG NO 40106616

Section 4: Wiring

4.1 General

4.1.1 General Information

The 1066 is easy to wire. All wiring connections are located on the main circuit board. The front panel is hinged at the bottom. The panel swings down for easy access to the wiring locations.

4.1.2 Digital Communication

HART and FOUNDATION fieldbus communications are available as ordering options for 1066. HART units support Bell 202 digital communications over analog 4-20mA current output 1.

4.2 Power Supply/Current Loop – 1066 - HT

4.2.1 Power Supply and Load Requirements

Refer to Figure 4-1. The supply voltage must be at least 12.7 Vdc at the transmitter terminals.. The power supply must be able to cover the voltage drop on the cable as well as the load resistor (250 Ω minimum) required for HART communications. The maximum power supply voltage is 42.0 Vdc. For intrinsically safe installations, the maximum power supply voltage is 30.0 Vdc. The graph shows load and power supply requirements. The upper line is the power supply voltage needed to provide 12.7 Vdc at the transmitter terminals for a 22 mA current. The lower line is the power supply voltage needed to provide 30 Vdc for a 22 mA current. The power supply must provide a surge current during the first 80 milliseconds of startup. The maximum current is about 24 mA.

For digital communications, the load must be at least 250 ohms. To supply the 12.7 Vdc lift off voltage at the transmitter, the power supply voltage must be at least 17.5 Vdc.

FIGURE 4-1. Load/Power Supply Requirements

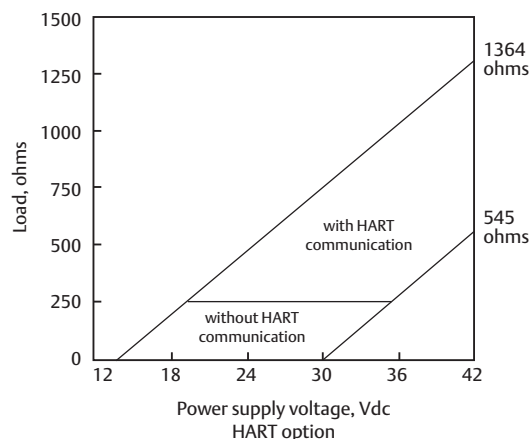

4.2.2 Power Supply-Current Loop Wiring

Refer to Figure 4-2.

Run the power/signal wiring through the opening nearest TB-2.

For optimum EMI/RFI protection:

1. Use shielded power/signal cable and ground the shield at the power supply.
2. Use a metal cable gland and be sure the shield makes good electrical contact with the gland.
3. Use the metal backing plate when attaching the gland to transmitter enclosure. The power/signal cable can also be enclosed in an earth-grounded metal conduit.

Do not run power supply/signal wiring in the same conduit or cable tray with loop power lines. Keep power supply/signal wiring at least 6 ft (2 m) away from heavy electrical equipment.

FIGURE 4-2. HART Communications

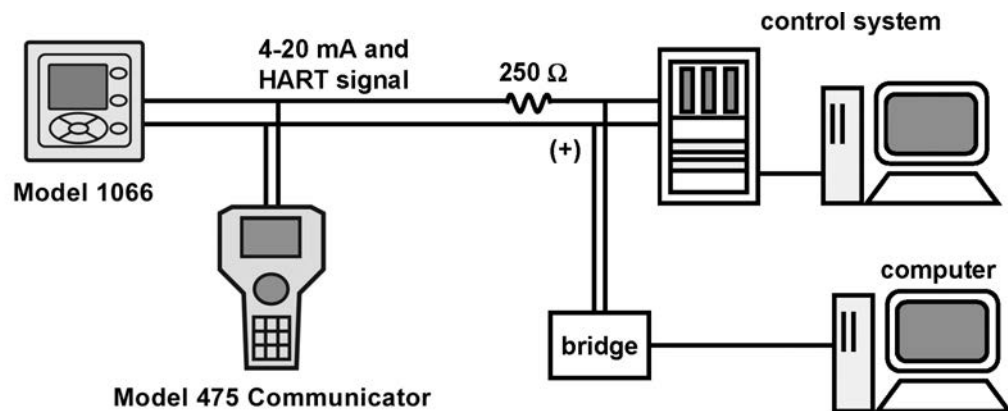

4.2.3 Current Output wiring

The 1066 HART units are shipped with two 4-20mA current outputs. Current Output 1 is loop power; it is the HART communications channel. Current output 2 is available to report process temperature measured by the temperature sensing element or RTD within the sensor.

Wiring locations for the outputs are on the main board which is mounted on the hinged door of the instrument. Wire the output leads to the correct position on the main board using the lead markings (+/positive, -/negative) on the board.

FIGURE 4-3. 1066 HART Loop Power Wiring

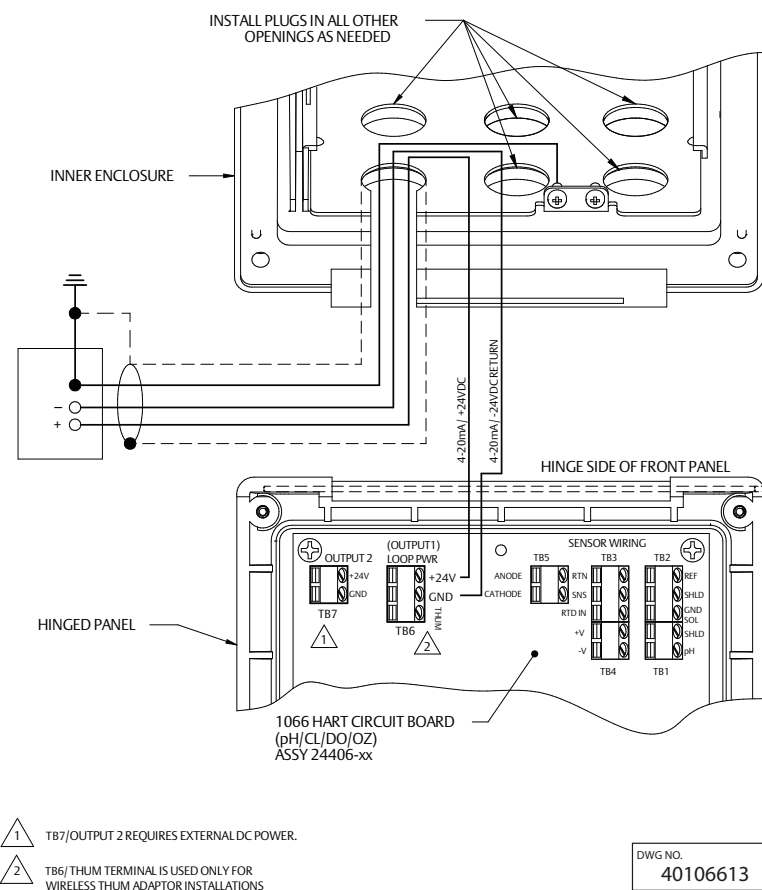

4.3 Power Supply Wiring For 1066-FF

Power Supply Wiring

4.3.1

Run the power/signal wiring through the opening nearest TB2. Use shielded cable and ground the shield at the power supply. To ground the transmitter, attach the shield to TB2-3.

Note: For optimum EMI/RFI immunity, the power supply/output cable should be shielded and enclosed in an earth-grounded metal conduit. Do not run power supply/signal wiring in the same conduit or cable tray with loop power lines. Keep power supply/signal wiring at least 6 ft (2 m) away from heavy electrical equipment.

FOUNDATION Fieldbus

Figure 4-4 shows a 1066PFF being used to measure and control pH and chlorine levels in drinking water. The figure also shows three ways in which Fieldbus communication can be used to read process variables and configure the transmitter.

FIGURE 4-4. Configuring 1066P Transmitter with FOUNDATION fieldbus

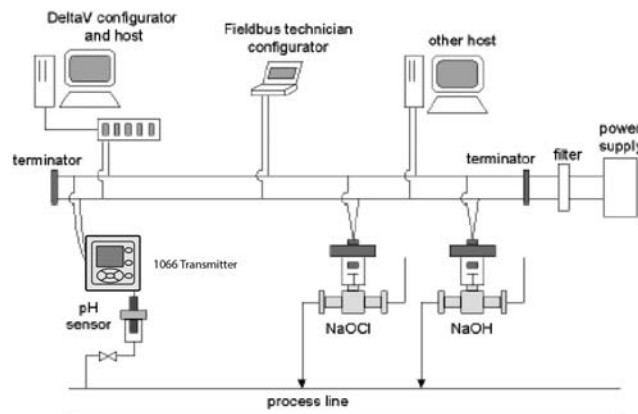
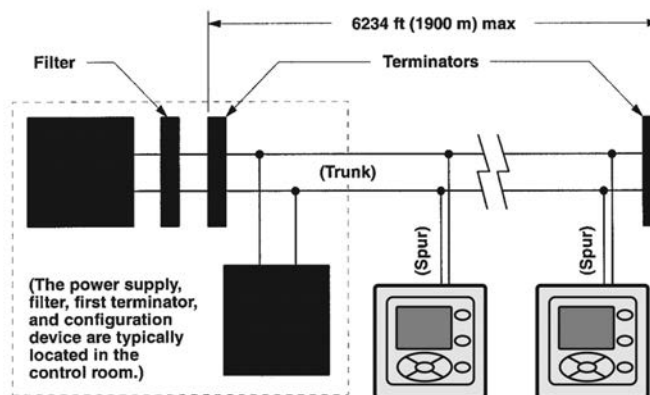

FIGURE 4-5. Typical Fieldbus Network Electrical Wiring Configuration



4.4 Sensor Wiring to Main Board

Wire the correct sensor leads to the main board using the lead locations marked directly on the board. Rosemount SMART pH sensors can be wired to the 1066 using integral cable SMART sensors or compatible VP8 pH cables. After wiring the sensor leads, carefully take up the excess sensor cable through the cable gland.

Keep sensor and output signal wiring separate from loop power wiring. Do not run sensor and power wiring in the same conduit or close together in a cable tray.

FIGURE 4-6. pH/ORP sensor wiring to the 1066 printed circuit board

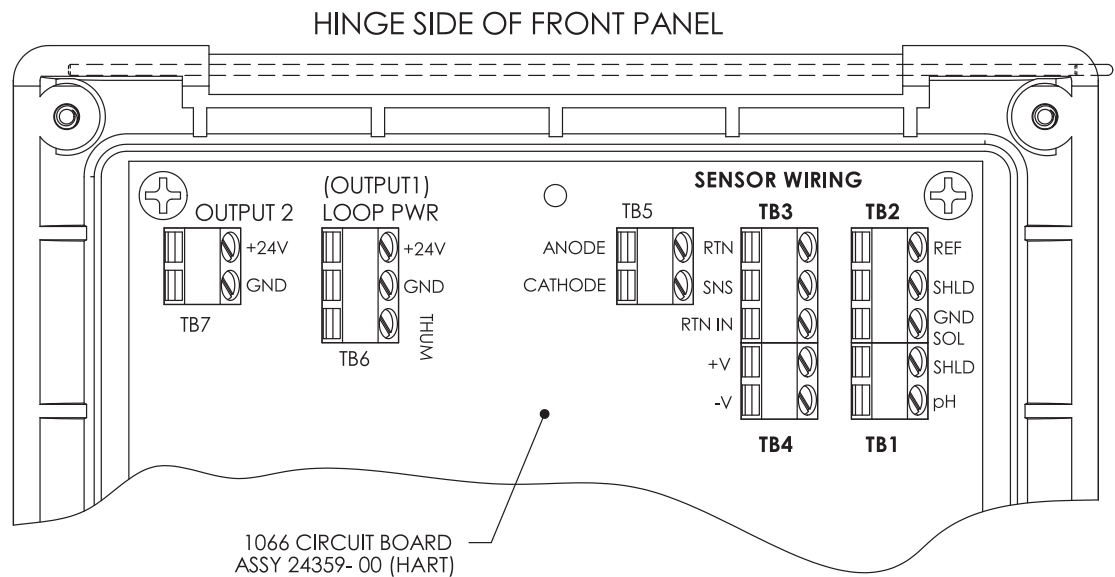

pH/ORP SENSOR WIRING (FOLLOW RECOMMENDED ORDER)

- | | | |
|--|--|---|
| 1) TB3/RTD | | RETURN
SENSE
RTD IN |
| 2) TB2/REFERENCE & SOLUTION GND | | REFERENCE IN
REFERENCE SHIELD
SOLUTION GROUND |
| 3) TB4/PREAMP (IF PRESENT) | | +VOLTS
-VOLTS |
| 4) TB1/pH INPUT | | pH SHIELD
pH IN |

DWG NO.
40106612

NOTE:

- A) IF GROUND LEAD IS PRESENT, TERMINATE IT TO GREEN GROUND SCREW ON INNER ENCLOSURE.
- B) TB5, TB6 AND TB7 NOT USED FOR pH/ORP SENSOR WIRING.

FIGURE 4-7. Contacting and Toroidal Conductivity sensor wiring to the 1066 circuit board

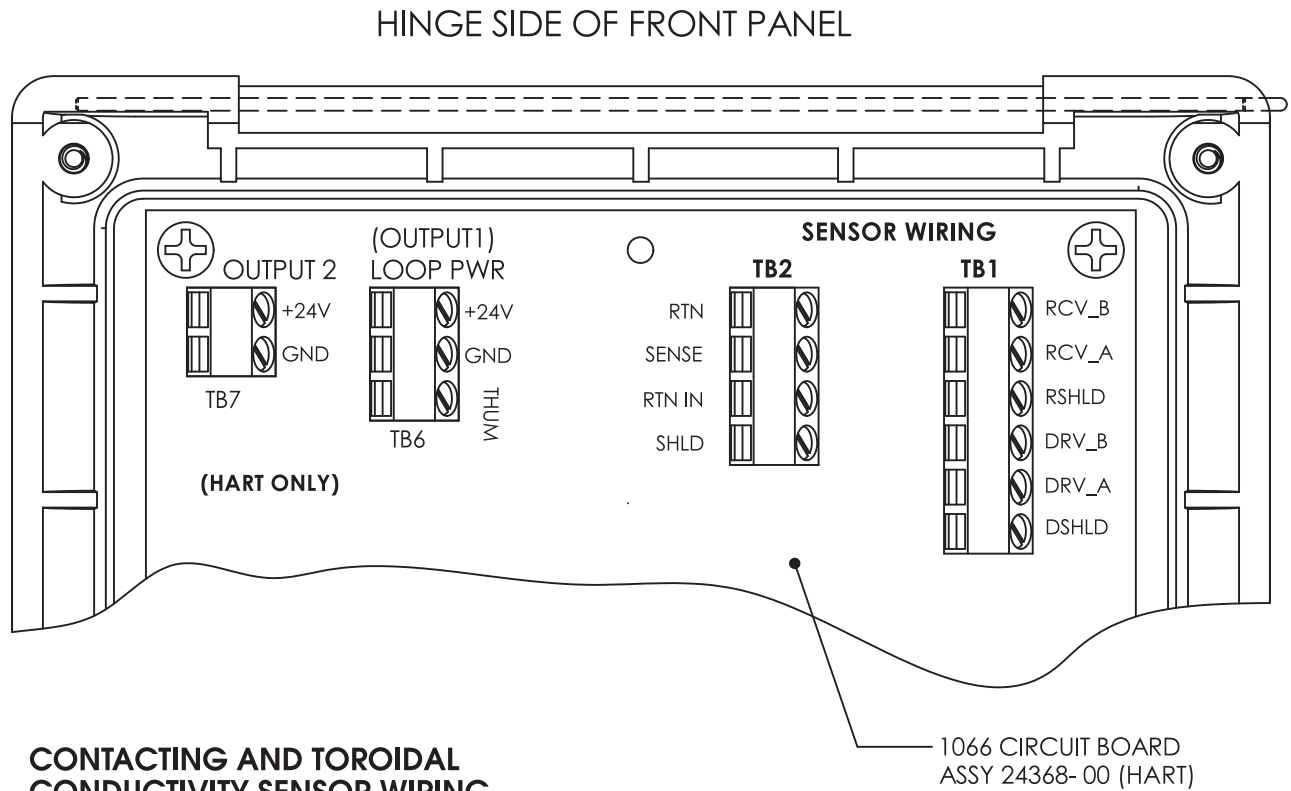

CONTACTING AND TOROIDAL CONDUCTIVITY SENSOR WIRING
 (FOLLOW RECOMMENDED ORDER)

1) **TB2/RTD**

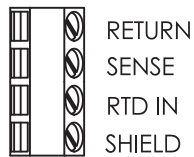

2) **TB1/CONDUCTIVITY**

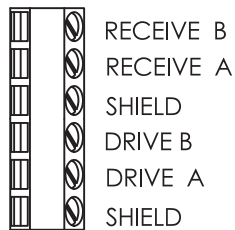

DWG NO. 40106615

FIGURE 4-8. Chlorine, oxygen, ozone sensor wiring to 1066 printed circuit board (1066-CL, 1066-DO, 1066-OZ)

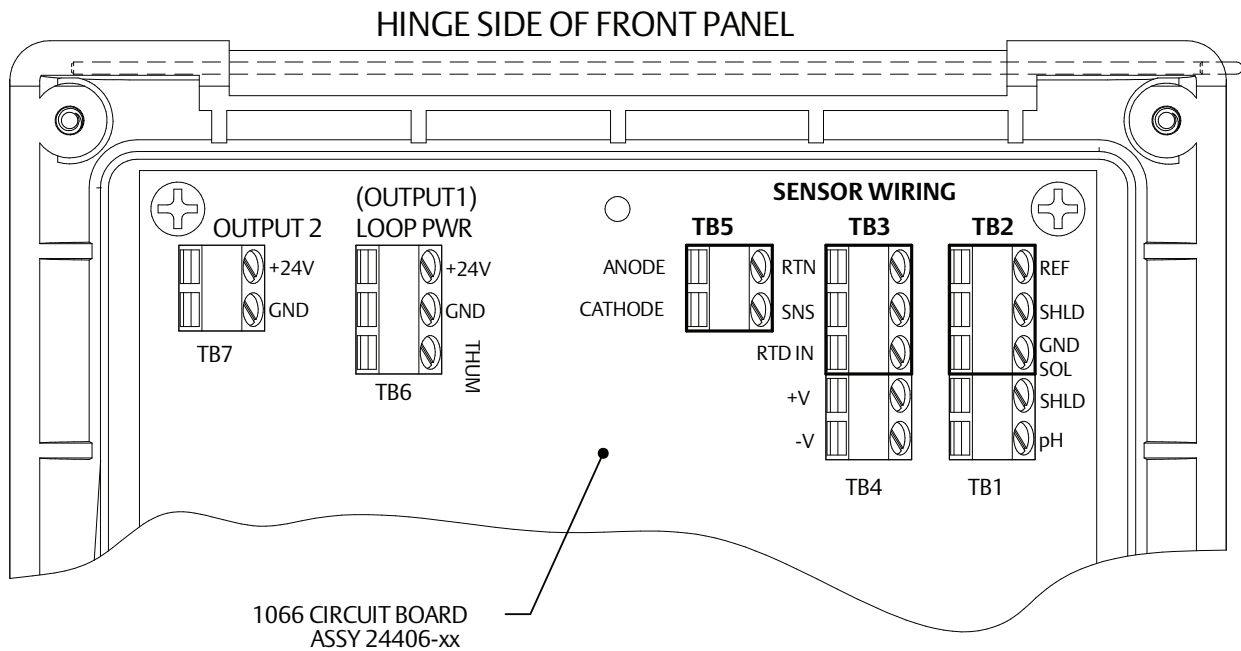

CHLORINE, OXYGEN, OZONE SENSOR WIRING
(FOLLOW RECOMMENDED ORDER)

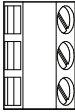
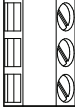
- 1) **TB5**/ANODE & CATHODE  ANODE
CATHODE
- 2) **TB3**/RTD  RETURN
SENSE
RTD IN
- 3) **TB2**/ SOLUTION GROUND  NO CONNECTION
NO CONNECTION
SOLUTION GROUND

NOTE:

- A) TB1, TB4, TB6 AND TB7 NOT USED FOR OXYGEN AND OZONE SENSOR WIRING
- B) TB1, TB2 AND TB4 MAY BE USED FOR pH SENSOR WIRING IF FREE CHLORINE MEASUREMENT REQUIRES LIVE pH INPUT.

DWG NO.
40106611

FIGURE 4-9. Power/Current Loop wiring with wireless THUM Adaptor

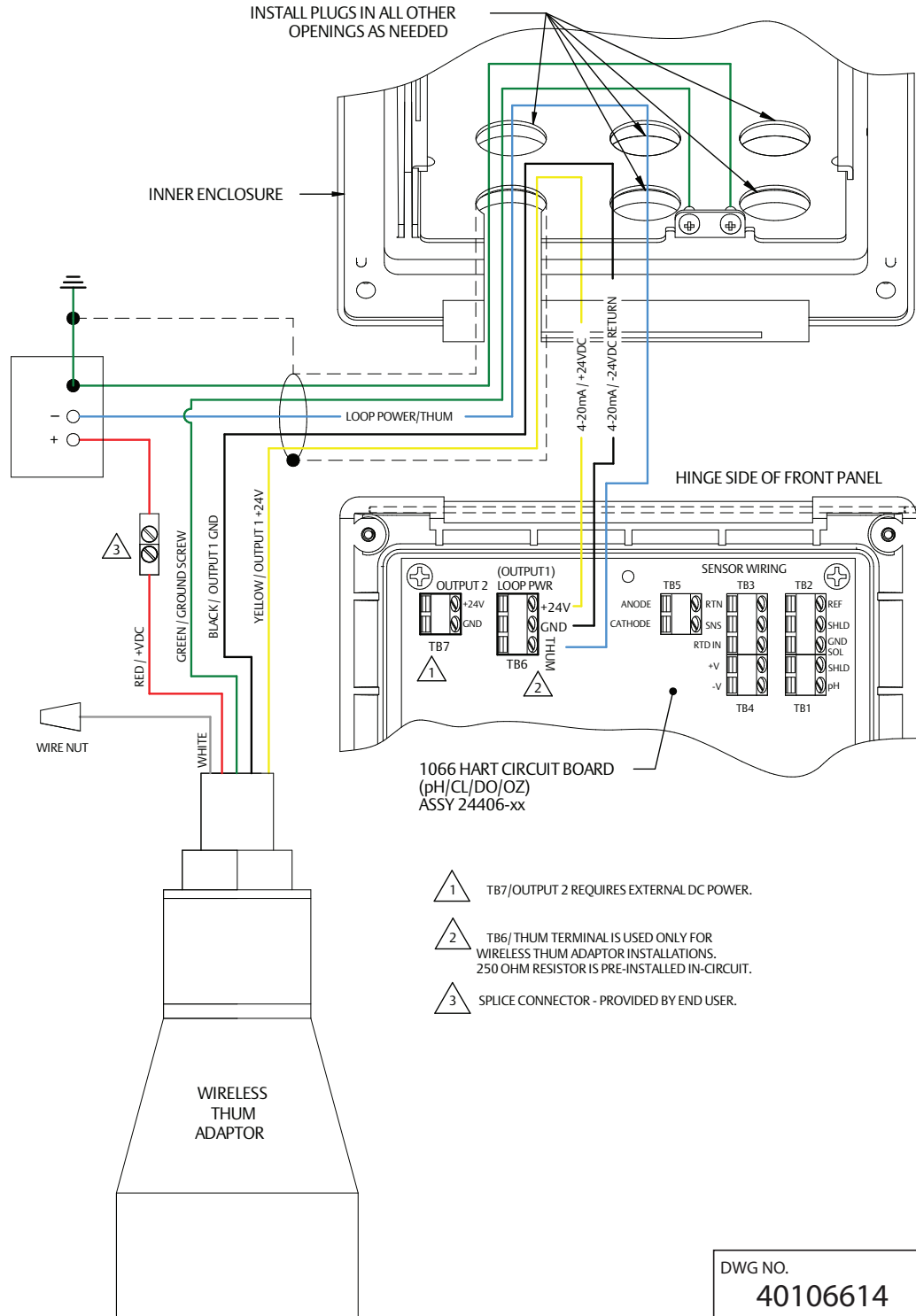
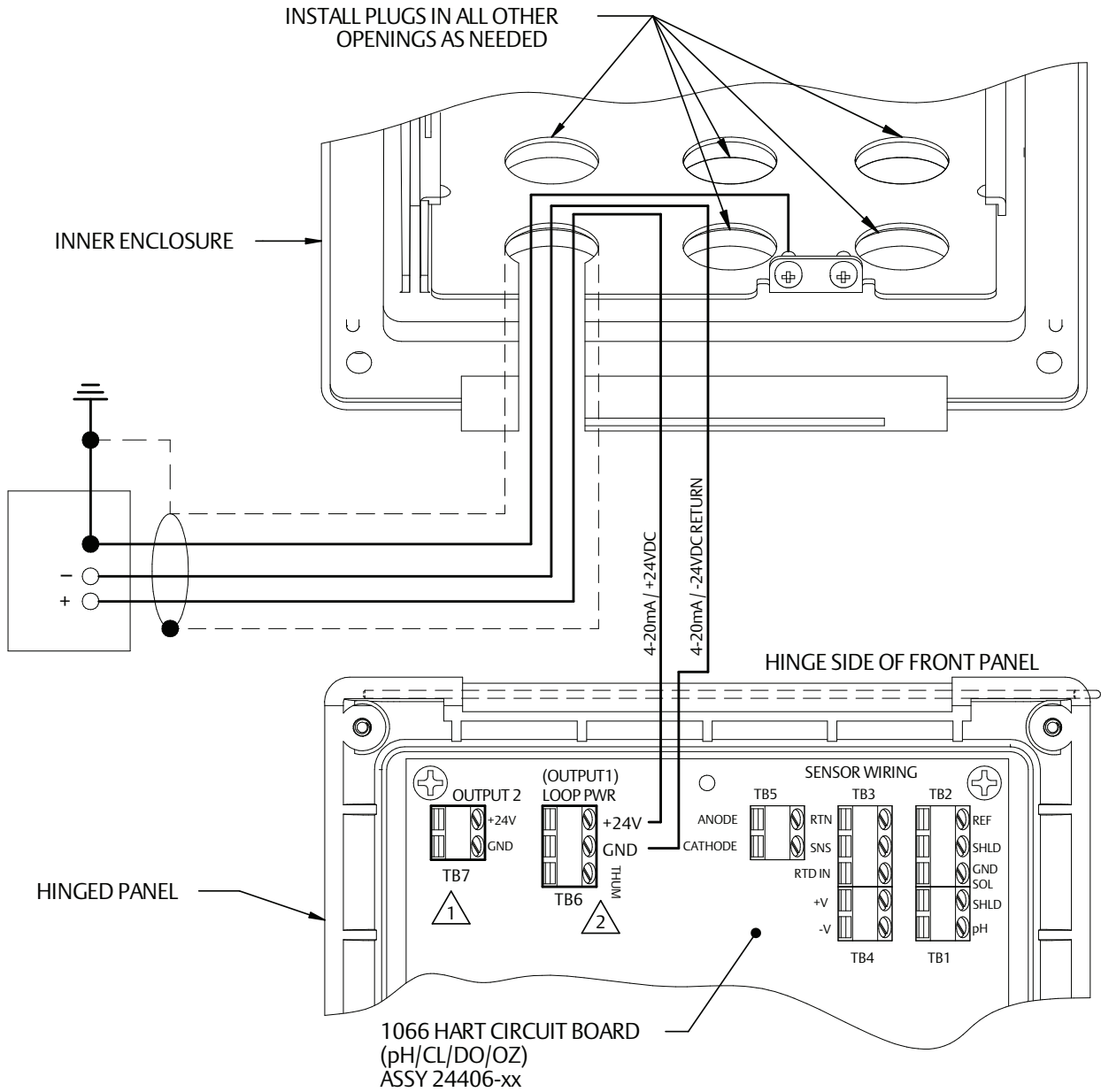

FIGURE 4-10. HART Loop Power Wiring



1 TB7/OUTPUT 2 REQUIRES EXTERNAL DC POWER.

2 TB6/THUM TERMINAL IS USED ONLY FOR WIRELESS THUM ADAPTOR INSTALLATIONS

DWG NO.
40106613

Section 5: Intrinsically Safe Installation

5.1 All Intrinsically Safe Installations

FIGURE 5-1. CSA Installation

AGENCY CONTROLLED DOCUMENT
ANY CHANGES WILL REQUIRE
SUBMITTAL FOR APPROVAL

ASSOCIATED TERMINALS —
Vmax OR U
Voc, V1 OR Uo
Pc, I1 OR Uo
Prex OR P1
Ct + Ccable
Li + Lcable
Voc, V1 OR Uo
Pc, I1 OR Uo
Prex OR P1
Ct + Ccable
Li + Lcable

14. 1066 MUST NOT BE CONNECTED TO EQUIPMENT GENERATING MORE THAN 250 VAC.
THE OUTPUT PARAMETERS SPECIFIED IN TABLE 2 ARE VALID FOR EITHER PREAMPLIFIER. PREAMPLIFIERS MEETING THESE OUTPUT PARAMETERS INCLUDE ROSEMOUNT 23546-00, 23538-00, 23551-00 AND 1700702 PREAMPLIFIER ASSEMBLIES. A WEATHER RESISTANT ENCLOSURE MUST HOUSE THE TYPE 23546-00 REMOTE PREAMPLIFIER.

15. CONTACTING CONDUCTIVITY SENSORS, AMPHROMIC AND pH SENSORS WITHOUT PREAMPS SHALL MEET THE REQUIREMENTS OF SIMPLE APPARATUS AS THAT DOES NOT DISIPATE MORE THAN 1.5 W.

16. THE MODEL 1066 HAS SYSTEMS APPROVAL FOR USE WITH MODELS 295, 295, 295 AND 298 TOROIDAL SENSORS. THE 1066 HAS SYSTEMS APPROVAL FOR USE WITH MODELS 140, 141, 142, 150, 400, 400VP, 401, 402, 402VP, 403, 403VP, 404 & 404VP CONTACTING CONDUCTIVITY SENSORS OR ANY SIMPLE APPARATUS WITH LESS THAN 200 FEET OF ATTACHED CABLE. 1066 MODELS WITH P/CI/O/CO/2 OPTIONS HAVE OUTPUT ENTITY PARAMETERS WHICH ALLOW THE USE OF VARIOUS SENSORS. WHERE: CG ≥ Ct (SENSOR) + Ccable; I1 ≤ I1 (SENSOR) + Lcable.

17. ANY SINGLE SHUNT THERMISTOR SAFETY BARrier APPROVED BY CSA HAVING THE FOLLOWING OUTPUT PARAMETERS:
Vmax OR V1 ≤ 30 V FOR 1064_...HT1...; 300 mA FOR 1064_...FF...
Prex ≤ 0.75 W FOR 1064_...HT1...; 513 mW FOR 1064_...FF...
The INTRINSICALLY SAFE ENTITY CONCEPT ALLOWS INTERCONNECTION OF INTRINSICALLY SAFE DEVICES WITH ASSOCIATED APPARATUS WHEN THE FOLLOWING IS TRUE:
FIELD DEVICE: IIBILLI ASSOCIATED APPARATUS: OUIPII

18. INTRINSICALLY SAFE APPARATUS (MODELS 1066, 1064, 1066, 375, 471) AND ASSOCIATED APPARATUS (SAFETY BARRIER) SHALL MEET THE VOLTAGE (Voc, OR V1) AND CURRENT (Ic, OR I1) WHICH CAN BE DEVELOPED BY THE ASSOCIATED APPARATUS (SAFETY BARRIER). IN ADDITION, THE MAXIMUM CAPACITANCE (Ct AND Ccable) AND INDUCTANCE (Li) WHICH CAN BE SAFELY CONNECTED TO THE APPARATUS (REF. TABLES I, II AND II).

19. ASSOCIATED APPARATUS MANUFACTURER'S INSTALLATION DRAWING MUST BE FOLLOWED WHEN INSTALLING THIS EQUIPMENT.

20. CONTROL EQUIPMENT CONNECTED TO ASSOCIATED APPARATUS MUST NOT USE OR GENERATE MORE THAN 250 Vrms OR Voc.
INSTALLATION SHOULD BE IN ACCORDANCE WITH ANSI/ISA IEC 120.6.01 "INSTALLATION OF INTRINSICALLY SAFE SYSTEMS FOR HAZARDOUS (CLASSIFIED) LOCATIONS" AND THE CANADIAN ELECTRICAL CODE, CSA C22.1, PART 1, APPENDIX F.

21. DUST-TIGHT CONDUIT SEAL MUST BE USED WHEN INSTALLED IN CLASS I AND CLASS II ENVIRONMENTS.

22. METAL CONDUIT IS NOT REQUIRED IN INTRINSICALLY SAFE INSTALLATIONS. HOWEVER, IF CONDUIT IS USED, BONDING BETWEEN CONDUIT IS NOT AUTOMATIC AND MUST BE PROVIDED AS PART OF THE INSTALLATION.

23. RESISTANCE BETWEEN INTRINSICALLY SAFE GROUND AND EARTH GROUND MUST BE LESS THAN 1.0 Ohm.

24. THE ASSOCIATED APPARATUS MUST BE CSA APPROVED.
1. NO REVISION TO DRAWINGS WITHOUT PRIOR CSA APPROVAL. THIS IS AN AGENCY CONTROLLED DRAWING.
NOTES: UNLESS OTHERWISE SPECIFIED

WHERE: 'A' = MEASUREMENT TYPE EXAMPLES:
P = pH/ORP
Ct = AMPHROMIC CHLORINE
I1 = AMPHROMIC CHLORINE
CO = AMPHROMIC OZONE
I = AMPHROMIC CURRENT
L = TOROIDAL CONDUCTIVITY

WHERE: BB = ANALOG/DIGITAL OUTPUT TYPE EXAMPLE:
CI = ANALOG/DIGITAL OUTPUT
FF = FOUNDATION RELIABLE DIGITAL COMMUNICATION OPTION
HT = FOUNDATION RELIABLE DIGITAL COMMUNICATION OPTION
I1 = FOUNDATION RELIABLE DIGITAL COMMUNICATION OPTION
HT1 = FOUNDATION RELIABLE DIGITAL COMMUNICATION OPTION
HT2 = FOUNDATION RELIABLE DIGITAL COMMUNICATION OPTION

WHERE: 'C' = FISCO (RELIABLE INTRINSICALLY SAFE CONCEPT) DIGITAL COMMUNICATION OPTION
FF = FOUNDATION RELIABLE DIGITAL COMMUNICATION OPTION
HT = FOUNDATION RELIABLE DIGITAL COMMUNICATION OPTION
HT1 = FOUNDATION RELIABLE DIGITAL COMMUNICATION OPTION
HT2 = FOUNDATION RELIABLE DIGITAL COMMUNICATION OPTION

WHERE: 'A' = MARKED WITH CSA LOGO AS INTRINSICALLY SAFE, NON-INCONCLUSIVE
OR = MARKED WITH CSA LOGO AS INTRINSICALLY SAFE, NON-INCONCLUSIVE

TABLE I (FOR 1068-P/CI/O/CO/2...)

GROUPS	Cl (uF)	I1 (mA)	Li (mH)
A, B	1.44	1.51	
C	9.39	6.04	
D	38.5	12.08	

TABLE II (FOR 1066-P/CI/O/CO/2...)

OUTPUT PARAMETERS	MODEL 1066
Uo	11.88 V
I1o	15.4 mA
Io	231 mA
Co	3762 pF
Lo	151.85 mH

TABLE III

1066 SUPPLY ENTITY PARAMETERS	Vmax (VDC)	Imax (mA)	Pmax (W)	Q (pF)	Li (mH)
1066_...HT1...COM/PAMP... 2 & 3 SIGNAL TERMINALS 1 & 2	30	200	0.9	0	0
1066_...HT2...ANALOG OUTPUT 2 SIGNAL TERMINALS 1 & 2	30	200	0.9	0	0
1066_...FF1...ENTITY LOOP POWER SIGNAL TERMINALS 1 & 2	30	300	1.3	0	0
1066_...HT1...1066_...HT2... SIGNAL TERMINALS 1 & 2	17.5	390	5.32	0	0

ENTITY PARAMETERS: REMOTE TRANSMITTER INTERFACE

MODEL NO.	Vmax IN Vdc	Imax IN mA	Pmax IN W	Q (pF)	Li (mH)	Vocmax OUT Vdc	Icmax OUT mA
275 OR 276	30	200	1.0	0.0	0.0	1.9	32

(475) INSTALLATION DRAWING IS 04/75-1130

1400669 E

FIGURE 5-6. FM installation

APPROVED MODELS 1066-AA-BB-CC-XXMTR

WHERE "AA" = MEASUREMENT TYPE:
 CI = AMPHOMETRIC CHLORINE
 DO = AMPHOMETRIC DISSOLVED OXYGEN
 PH = PH
 C = CONTACTING CONDUCTIVITY

WHERE "BB" = TOROIDAL CONDUCTIVITY:
 TT = TOROIDAL ANALOG CURRENT LOOP OUTPUT AND HART COMMUNICATION
 FF = FOUNDATION FIELDS DIGITAL COMMUNICATION OPTION
 CC = HAZARDOUS AREA CERTIFICATION (BLANK IF NOT SELECTED)

WHERE "XX" = MARKED WITH FM LOGO AS INTRINSICALLY SAFE, NONINCENDIVE

18. IF USING MODEL 275 OR 475 COMMUNICATOR, OR MODEL 775 THIN WIRELESS ADAPTER, MANUFACTURER'S INSTALLATION DRAWING MUST BE FOLLOWED.

INSTALLATION TO BE IN ACCORDANCE WITH THE NATIONAL ELECTRICAL CODE.

NONINCENDIVE FIELD WIRING METHODS MAY BE USED FOR CONNECTING SENSORS TO THE INSTRUMENT. ATTACHED SENSORS MUST BE FM APPROVED AND LISTED TO THE NATIONAL FIRE PROTECTION ASSOCIATION (NFPA) TABLE 1 AND THE CLASS AND LIST OF THE SENSOR AND INTERCONNECTED WIRING MUST BE THE VALUE OF Cg AND CL FROM TABLE 1 OR BE CLASSIFIED AS "SIMPLE APPARATUS". SIMPLE APPARATUS ARE DEVICES WHICH ARE INCAPABLE OF GENERATING OR STORING MORE THAN 1.2 V, 0.1 A, 25 mW OR 20 μJ (100 AMPHOMETRIC SENSORS WITHOUT PREPAMS AND CONTACTING CONDUCTIVITY SENSORS QUALIFY AS SIMPLE APPARATUS).

DIVISION 2 WIRING METHOD PER THE NEC (EXCLUDING NONINCENDIVE FIELD WIRING).

METAL CONDUIT IS NOT REQUIRED FOR INTRINSICALLY SAFE INSTALLATIONS. HOWEVER, IF CONDUIT IS USED, BONDING BETWEEN CONDUITS NOT AUTOMATIC, AND MUST BE PROVIDED AS PART OF THE INSTALLATION.

NO REVISION TO DRAWING WITHOUT PRIOR FM APPROVAL - AGENCY CONTROLLED DOCUMENT.

THE ASSOCIATED APPARATUS MUST BE FM APPROVED AND MUST BE RESISTIVELY LIMITED HAVING LINEAR OUTPUTS.

CONTROL EQUIPMENT CONNECTED TO ASSOCIATED APPARATUS MUST NOT USE OR GENERATE MORE THAN 250 Vrms OR Vdc.

ASSOCIATED APPARATUS MANUFACTURER'S INSTALLATION DRAWING MUST BE FOLLOWED WHEN INSTALLING THIS EQUIPMENT.

THE INTRINSICALLY SAFE ENTITY CONCEPT ALLOWS INTERCONNECTION OF INTRINSICALLY SAFE DEVICES WITH ASSOCIATED APPARATUS WHEN THE FOLLOWING IS TRUE:

FIELD DEVICE INPUT = ASSOCIATED APPARATUS OUTPUT
 Imax OR Ii = Imax OR Ii
 Pmax OR Pi = Pmax OR Pi
 U + L Capacitance = U + L OR Lg

RESISTANCE BETWEEN INTRINSICALLY SAFE GROUND AND EARTH GROUND MUST BE LESS THAN 1.0 Ohm.

DUST-TIGHT CONDUIT SEAL MUST BE USED WHEN INSTALLED IN CLASS II AND CLASS III ENVIRONMENTS.

CONTACTING CONDUCTIVITY SENSORS, AMPHOMETRIC AND PH SENSORS WITHOUT PREPAMS SHALL MEET THE REQUIREMENTS OF SIMPLE APPARATUS AS DEFINED IN ANSI/ISA IEC 726 AND THE NEC, ANSI/NFPA 70. THEY CANNOT GENERATE NOR STORE MORE THAN 1.5 V, 100 mA, 25 mW OR A PASSIVE COMPONENT THAT DOES NOT DISPERSE MORE THAN 1.5mJ.

INSTALLATION SHOULD BE IN ACCORDANCE WITH ANSISA IEC 726 (1) INSTALLATION OF INTRINSICALLY SAFE SYSTEMS FOR HAZARDOUS CLASSIFIED LOCATIONS AND THE NATIONAL ELECTRICAL CODE (ANSI/NFPA 70) SECTIONS 504 AND 505.

WHERE CONNECTIONS ARE MADE TO 1066-HF OPTION ANALOG OUTPUT 2 (IB7, 8 & 9), SEPARATE WIRING AND A SECOND BARRIER ARE REQUIRED WITHIN EACH BARRIER MUST BE INSTALLED AS SEPARATE INTRINSICALLY SAFE CIRCUITS IN ACCORDANCE WITH THE NATIONAL ELECTRICAL CODE.

INTRINSICALLY SAFE APPARATUS (MODEL 1066-SMART THIN WIRELESS ADAPTER, MODEL 375, 475 AND ASSOCIATED APPARATUS (SAFETY BARRIER) SHALL MEET THE FOLLOWING REQUIREMENTS: THE VOLTAGE (Vmax) AND CURRENT (Imax) OF THE INTRINSICALLY SAFE APPARATUS MUST BE EQUAL TO OR GREATER THAN THE VOLTAGE AND CURRENT OF THE INTRINSICALLY SAFE APPARATUS TO WHICH IT IS CONNECTED. IN ADDITION, THE MAXIMUM UNPROTECTED CAPACITANCE (Cg) AND INDUCTANCE (Lg) OF THE INTRINSICALLY SAFE APPARATUS (INCLUDING INTERCONNECTING WIRING) MUST BE EQUAL OR LESS THAN THE CAPACITANCE (Cg) AND INDUCTANCE (Lg) WHICH CAN BE SAFELY CONNECTED TO THE APPARATUS (SEE TABLES 1.I AND II).

THE MODEL 1066-C/7 HAS SYSTEM APPROVAL FOR USE WITH MODELS 225, 226 & 228 TOROIDAL SENSORS OR 140, 141, 142, 150, 400, 401, 402. 1066-MODELS WITH P1 AND P2 OPTIONS HAVE OUTPUT ENTITY PARAMETERS WHICH ALLOW THE USE OF VARIOUS SENSORS WHICH MAY BE SIMPLE APPARATUS OR HAVE FM APPROVED ENTITY PARAMETERS. SO LONG AS THE CAPACITANCE AND INDUCTANCE OF THE LOAD CONNECTED TO THE SENSORS DO NOT EXCEED THE VALUES SPECIFIED IN TABLE 1 WHERE:
 Cg <= Cg (SENSOR) AND Lg <= Lg (SENSOR) AND Lg <= Lg (BARRIER) CODE

ANY SINGLE WIRE BARRIER (OR BARRIERS APPROVED BY FM HAVING THE FOLLOWING OUTPUT PARAMETERS: SUPPLY/SIGNAL TERMINALS TB-1 AND 2 FOR FIELDS OPTION OR TB-1, 2 AND 3 FOR HART OPTION, ALSO TB-1 AND 2 FOR ANALOG OUTPUT 2) IS USED.
 Vdc OR Vt <= 30 V FOR 1066-HF... = 17.5 Vdc FOR 1066-HF... = 306.5 mA FOR 1066-HF... = 1.3 W FOR 1066-HF... = 5.32 mW FOR 1066-HF...
 Pmax < 10.2 W FOR 1066-HF... = 1.3 W FOR 1066-HF... = 5.32 mW FOR 1066-HF...

NOTES: UNLESS OTHERWISE SPECIFIED

TABLE I (FOR 1066-P/CL/D/O/OZ...)

GAS GROUPS	OUTPUT PARAMETERS			MODEL 1066 TB1 - 1 THRU 12		
	Cg (uF)	LI (mH)	FI	HT	FF	FI
II C	2.22	1.7	0.795	5.86	5.17	
II B	15.5	11.6	3.17	23.5	20.71	
II A	83.9	47.9	16.36	47	41.41	

TABLE II (FOR 1066-P/CL/D/O/OZ...)

OUTPUT PARAMETERS	MODEL 1066 TB1 - 1 THRU 12		
	HT	FF	FI
Ub (V) Voids	10.69	11.33	11.33
Ib (IO) mA	211.2	27.77	82.86
Po (PI) mW	250	110.12	17.33

TABLE III

1066 ENTITY PARAMETERS SUPPLY

MODEL NO.	Vmax (Vdc)	Imax (mA)	Pmax (W)	Ci (nF)	Li (uH)
1066-HF LOOP POWER SIGNAL TERMINALS TB6 - 2 AND 3	30	200	0.9	0	8.95
1066-HF ANALOG OUTPUT 2 SIGNAL TERMINALS TB7 - 1 AND 2	30	200	0.9	0	5.97
1066-FFFI - ENTITY LOOP POWER SIGNAL TERMINALS TB6 - 1 AND 2	30	300	1.3	0	0
1066-FL ESCO LOOP POWER SIGNAL TERMINALS TB6 - 1 AND 2	17.5	380	5.32	0	0

ENTITY PARAMETERS: REMOTE TRANSMITTER INTERFACE

MODEL NO.	Vmax IN	Imax IN	Pmax IN	Ci (uF)	Li (mH)	Voc max OUT	Isc max OUT
375 OR 475	30 Vdc	200 mA	1.0 W	0.0	0.0	1.9 Vdc	32 uA

(475 INSTALLATION DRAWING IS 00475-1130)

20. THE FISCO CONCEPT ALLOWS INTERCONNECTION OF INTRINSICALLY SAFE APPARATUS TO ASSOCIATED APPARATUS NOT SPECIALLY EXAMINED IN SUCH COMBINATION. THE CRITERIA FOR INTERCONNECTION IS THAT THE VOLTAGE (U OR Vmax), THE CURRENT (I OR Imax) AND THE POWER (P OR Pmax) OF THE ASSOCIATED APPARATUS MUST BE EQUAL TO OR GREATER THAN THE VOLTAGE (Ug OR Vg), THE CURRENT (Ig OR Ii) AND THE POWER (Pg OR Pmax) LEVELS WHICH CAN BE DELIVERED BY THE ASSOCIATED APPARATUS, CONSIDERING FAULTS AND APPLICABLE FACTORS. IN ADDITION, THE MAXIMUM UNPROTECTED CAPACITANCE (Cg) AND INDUCTANCE (Lg) OF THE ASSOCIATED APPARATUS (OTHER THAN THE TERMINATION) CONNECTED TO THE FIELDS MUST BE LESS THAN OR EQUAL TO THE P1 AND P2 VALUES RESPECTIVELY.

IN EACH SEGMENT ONLY ONE ACTIVE DEVICE, NORMALLY THE ASSOCIATED APPARATUS, IS ALLOWED TO PROVIDE THE NECESSARY ENERGY FOR THE FIELDS SYSTEM. THE VOLTAGE (U OR Vg OR Vt) OF THE ASSOCIATED APPARATUS IS LIMITED TO A RANGE OF 14 V TO 24 Vdc. ALL OTHER EQUIPMENT CONNECTED TO THE BUS CANNOT BE PASSED THROUGH THE SAFETY BARRIER. THE VOLTAGE OF THE OTHER EQUIPMENT ISOLATION TO ASSURE THAT THE INTRINSICALLY SAFE FIELDS CIRCUIT REMAINS PASSIVE.

THE CABLE USED TO INTERCONNECT DEVICES NEEDS TO HAVE THE PARAMETERS IN THE FOLLOWING RANGE:

Loop Resistance R: 15.....150 Ohm/km
 Inductance per unit length Li: 80.....100 μH/m
 Capacitance per unit length Ci: 80.....100 pF/m
 C = Cline/m + 0.5C line/screen, if both lines are flooding, or
 C = Cline/m + Cline/screen, if the screens is connected to one line
 Length of spur cables: less than or equal to 30m
 Length of spur splices: less than or equal to 1m
 R <= 2.2 μF
 C <= 2.2 μF

AT EACH END OF THE TRUNK CABLE AN APPROVED INFALLIBLE LINE TERMINATION WITH THE FOLLOWING PARAMETERS IS SUITABLE:
 R <= 100 Ohm
 C <= 2.2 μF

ONE OF THE ALLOWED TERMINATIONS MIGHT ALREADY BE INTEGRATED IN THE ASSOCIATED APPARATUS. THE NUMBER OF PASSIVE APPARATUS CONNECTED TO THE BUS CANNOT EXCEED THE NUMBER OF ACTIVE APPARATUS. THE NUMBER OF PASSIVE APPARATUS PERMITTED DUE TO THIS REASON IS THE ABOVE BULLETS ARE RESPECTED, UP TO A TOTAL LENGTH OF 1000 m.

THE CAPACITANCE OF THE CABLE MUST BE LESS THAN OR EQUAL TO THE CAPACITANCE OF THE CABLE WILL NOT IMPAIR THE INTRINSIC SAFETY OF THE INSTALLATION.

FIG. NO. 1400670
 SCALE 1:1
 SHEET 1 OF 1
 E

FIGURE 5-8. FM installation

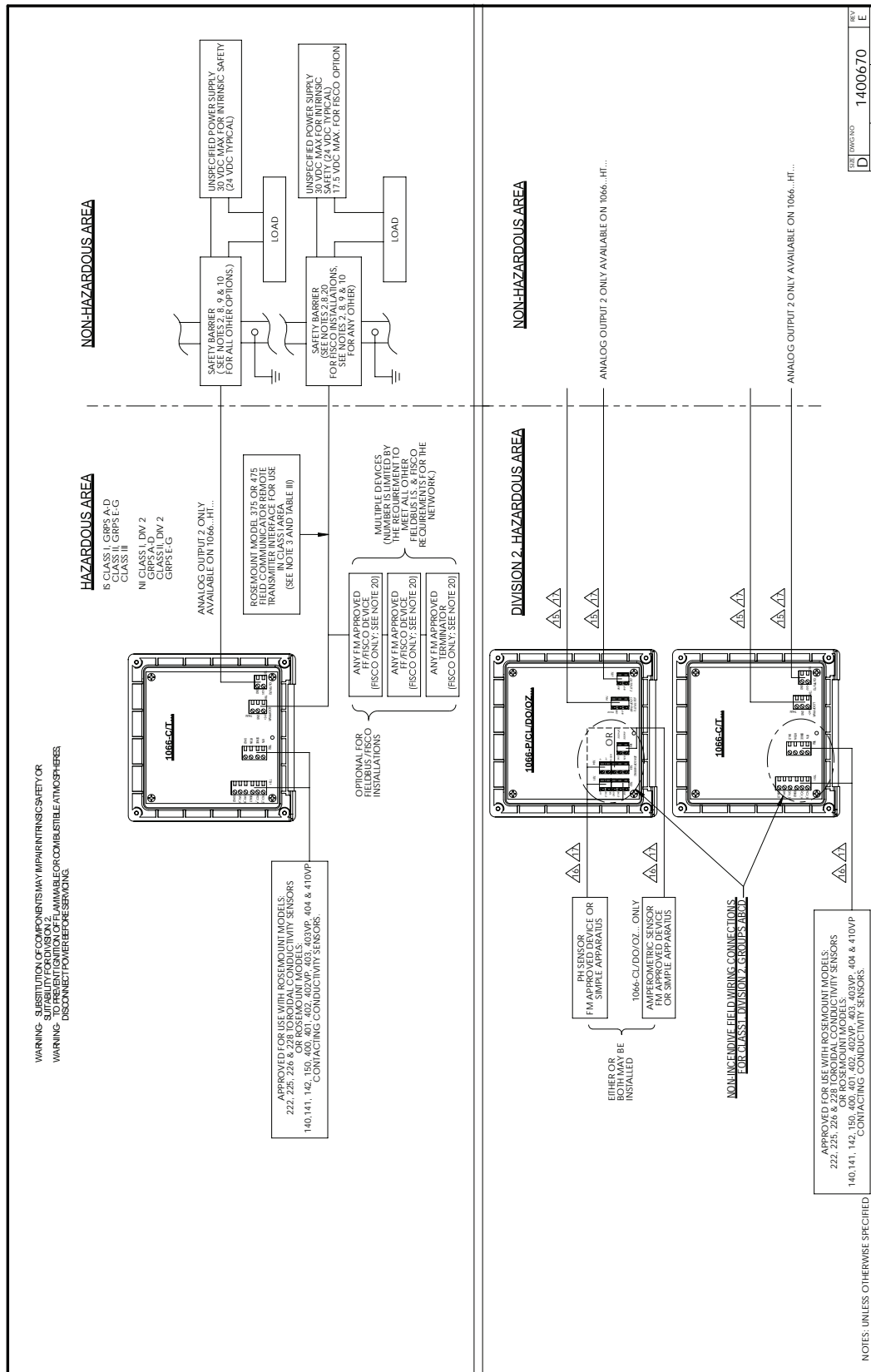

Section 6: Display and Operation

6.1 User Interface

The 1066 has a large display which shows the measurement readout and temperature in large digits and up to four additional process variables or diagnostic parameters concurrently. The displayed variables can be customized to meet user requirements. This is called display Format. The intuitive menu system allows access to Calibration, Hold (of current outputs), Programming, and Display functions. In addition, a dedicated DIAG button is available to provide access to useful operational information on installed sensor(s) and any problematic conditions that might occur. The display flashes Fault and/or Warning when these conditions occur. Help screens are displayed for most fault and warning conditions to guide the user in troubleshooting. During calibration and programming, key presses cause different displays to appear. The displays are self-explanatory and guide the user step-by-step through the procedure.



6.2 Instrument Keyboard

There are four Function keys and four Selection keys on the instrument keypad.

Function Keys:

The **MENU key** is used to access menus for programming and calibrating the instrument. Four top-level menu items appear when pressing the MENU key:

- Calibrate: calibrate the attached sensor and analog output(s).
- Hold: Suspend current output(s).
- Program: Program outputs, measurement, temperature, security and reset.
- Display: Program display format, language, warnings, and contrast

Pressing **MENU** from the main (live values) screen always causes the main menu screen to appear. Pressing MENU followed by EXIT causes the main screen to appear.

Pressing the **DIAG key** displays active Faults and Warnings, and provides detailed instrument information and sensor diagnostics including: Faults, Warnings, Sensor information, Out 1 and Out 2 live current values, model configuration string e.g. 1066-P-HT-60 and Instrument Software version. Pressing DIAG provides useful diagnostics and information (as applicable): Measurement, Sensor Type, Raw signal value, Cell constant, Zero Offset, Temperature, Temperature Offset, selected measurement range, Cable Resistance, Temperature Sensor Resistance, software version.

The ENTER key. Pressing ENTER stores numbers and settings and moves the display to the next screen.

The EXIT key. Pressing EXIT returns to the previous screen without storing changes.

Selection Keys:

Surrounding the ENTER key, four Selection keys – up, down, right and left, move the cursor to all areas of the screen while using the menus.

Selection keys are used to:

1. Select items on the menu screens
2. Scroll up and down the menu lists
3. Enter or edit numeric values
4. Move the cursor to the right or left
5. Select measurement units during operations

6.3 Main Display

The 1066 displays the primary measurement value and temperature, and up to four secondary measurement values, a fault and warning banner, and a digital communications icon.

Process Measurements:

One process variable and process temperature is displayed by default. For all configurations, the Upper display area shows the live process variable and the Center display area shows the Temperature (default screen settings).

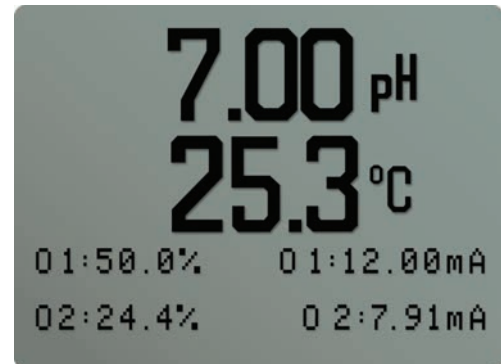

Secondary Values:

Up to four secondary values are shown in display quadrants at the bottom half of the screen. All four secondary value positions can be programmed by the user to any displayable parameter available.

Fault and Warning Banner:

If the transmitter detects a problem with itself or the sensor the word Fault or Warning will appear at the bottom of the display. A fault requires immediate attention. A warning indicates a problematic condition or an impending failure. For troubleshooting assistance, press Diag.

Formatting the Main Display

The main display screen can be programmed to show primary process variables, secondary process variables and diagnostics.

1. Press MENU
2. Scroll down to **Display**. Press **ENTER**.
3. **Main Format** will be highlighted. Press **ENTER**.
4. The sensor 1 process value will be highlighted in reverse video. Press the selection keys to navigate down to the screen sections that you wish to program. Press **ENTER**.
5. Choose the desired display parameter or diagnostic for each of the four display sections in the lower screen.
6. Continue to navigate and program all desired screen sections. Press **MENU** and **EXIT**. The screen will return to the main display.

The default display shows the live process measurement in the upper display area and temperature in the center display area. The user can elect to disable the display of temperature in the center display area using the Main Format function. See [Figure 4-1](#) to guide you through programming the main display to select process parameters and diagnostics of your choice.

6.4 Menu System

The 1066 uses a scroll and select menu system. Pressing the MENU key at any time opens the top-level menu including Calibrate, Hold, Program and Display functions.

To find a menu item, scroll with the up and down keys until the item is highlighted. Continue to scroll and select menu items until the desired function is chosen.

To select the item, press ENTER. To return to a previous menu level or to enable the main live display, press the EXIT key repeatedly. To return immediately to the main display from any menu level, simply press MENU then EXIT.

The selection keys have the following functions:

- The Up key (above ENTER) increments numerical values, moves the decimal place one place to the right, or selects units of measurement.
- The Down key (below ENTER) decrements numerical values, moves the decimal place one place to the left, or selects units of measurement
- The Left key (left of ENTER) moves the cursor to the left.
- The Right key (right of ENTER) moves the cursor to the right.

To access desired menu functions, use the Quick Reference. During all menu displays (except main display format and Quick Start), the live process measurement and temperature value are displayed in the top two lines of the Upper display area. This conveniently allows display of the live values during important calibration and programming operations. Menu screens will time out after two minutes and return to the main live display.

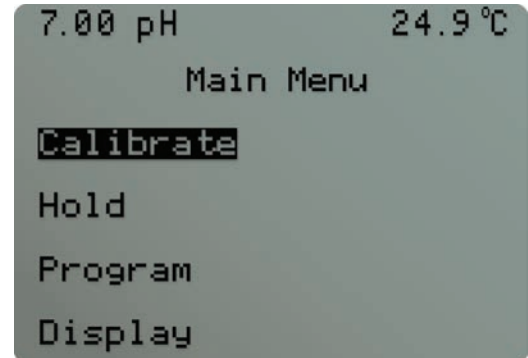

Section 7: Programming the Transmitter – Basics

7.1 General

Typical programming steps include the following listed procedures. Each of these programming functions are easily and quickly accomplished using the intuitive menu system.

- Changing the measurement type, measurement units and temperature units.
- Choose temperature units and manual or automatic temperature compensation mode
- Configure and assign values to the current outputs
- Set a security code for two levels of security access
- Accessing menu functions using a security code
- Enabling and disabling Hold mode for current outputs
- Resetting all factory defaults, calibration data only, or current output settings only

7.2 Changing Startup Settings

7.2.1 Purpose

To change the measurement type, measurement units, or temperature units that were initially entered in Quick Start, choose the Reset analyzer function or access the Program menus for the sensor. The following choices for specific measurement type, measurement units are available for each sensor measurement board.

TABLE 7-1. Measurements and Measurement Units

Signal board	Available measurements	Measurements units:
pH/ORP – P	pH, ORP, Redox	pH, mV (ORP, Redox)
Contacting conductivity - C	Conductivity, Resistivity, TDS, Salinity, NaOH (0-12%), HCl (0-15%), Low H ₂ SO ₄ , High H ₂ SO ₄ , NaCl (0-20%), Custom Curve	μS/cm, mS/cm, S/cm % (concentration)
Toroidal conductivity - T	Conductivity, Resistivity, TDS, Salinity, NaOH (0-12%), HCl (0-15%), Low H ₂ SO ₄ , High H ₂ SO ₄ , NaCl (0-20%), Custom Curve	μS/cm, mS/cm, S/cm % (concentration)
Chlorine - CL	Free Chlorine, Total Chlorine, Monochloramine	ppm, mg/L
Oxygen - DO	Oxygen (ppm), Trace Oxygen (ppb), Percent Oxygen in gas	ppm, mg/L, ppb, μg/L % Sat, Partial Pressure, % Oxygen In Gas, ppm Oxygen In Gas
Ozone - OZ	Ozone	ppm, mg/L, ppb, μg/L

7.2.2 Procedure

Follow the Reset Analyzer procedure (Section 7.8) to reconfigure the transmitter to display new measurements or measurement units. To change the specific measurement or measurement units for each measurement type, refer to the Program menu for the appropriate measurement (Section 6.0).

7.3 Choosing Temperature Units and Automatic/Manual Temperature Compensation

7.3.1 Purpose

Most liquid analytical measurements (except ORP and Redox) require temperature compensation. The 1066 performs temperature compensation automatically by applying internal temperature correction algorithms. Temperature correction can also be turned off. If temperature correction is off, the 1066 uses the temperature entered by the user in all temperature correction calculations.

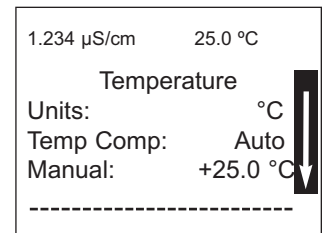

7.4 Configuring and Ranging Current Outputs

7.4.1 Purpose

The 1066 has two analog current outputs. Ranging the outputs means assigning values to the low (4 mA) and high (20 mA) outputs. This section provides a guide for configuring and ranging the outputs. ALWAYS CONFIGURE THE OUTPUTS FIRST.

7.4.2 Definitions

1. CURRENT OUTPUTS. The transmitter provides a continuous output current (4-20 mA) directly proportional to the process variable or temperature. The low and high current outputs can be set to any value.
2. ASSIGNING OUTPUTS. Assign a measurement or temperature to Output 1 or Output 2.
3. DAMPEN. Output dampening smooths out noisy readings. It also increases the response time of the output. Output dampening does not affect the response time of the display.
4. MODE. The current output can be made directly proportional to the displayed value (linear mode) or directly proportional to the common logarithm of the displayed value (log mode).

7.4.3 Procedure: Configure Outputs

Under the Program/Outputs menu, the adjacent screen will appear to allow configuration of the outputs. Follow the menu screens in Figure 7-1 to configure the outputs.

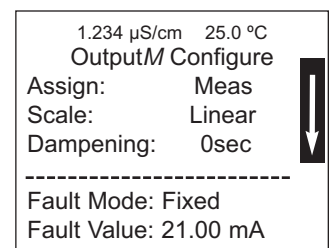
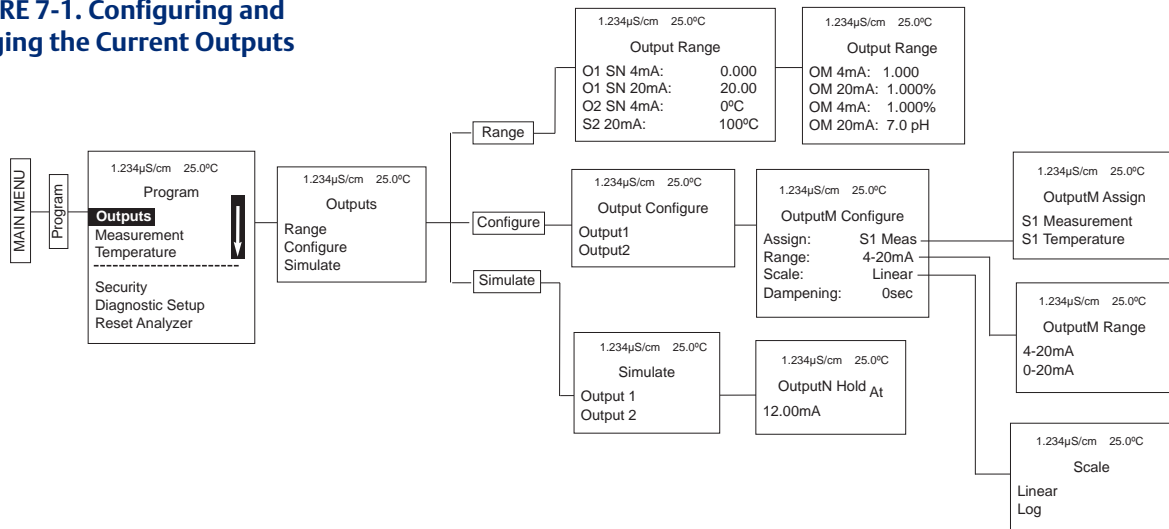
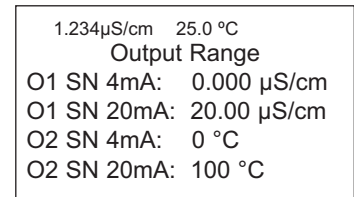

FIGURE 7-1. Configuring and Ranging the Current Outputs



7.4.4 Procedure: Ranging the Current Outputs

The adjacent screen will appear under Program/Output/Range. Enter a value for 4 mA and 20 mA for each output. Follow the menu screens in Figure 7-1 to assign values to the outputs.



7.5 Setting a Security Code

7.5.1 Purpose

The security codes prevent accidental or unwanted changes to program settings, displays, and calibration. The 1066 has two levels of security code to control access and use of the instrument to different types of users. The two levels of security are:

- **All:** This is the Supervisory security level. It allows access to all menu functions, including Programming, Calibration, Hold and Display.
- **Calibration/Hold:** This is the operator or technician level menu. It allows access to only calibration and Hold of the current outputs.

7.5.2 Procedure

1. Press MENU. The main menu screen appears. Choose **Program**.
2. Scroll down to Security. Select Security.
3. The security entry screen appears. Enter a three digit security code for each of the desired security levels. The security code takes effect two minutes after the last key stroke. Record the security code(s) for future access and communication to operators or technicians as needed.
4. The display returns to the security menu screen. Press EXIT to return to the previous screen. To return to the main display, press MENU followed by EXIT.

Figure 7-2 displays the security code screens.

FIGURE 7-2. Setting a Security Code

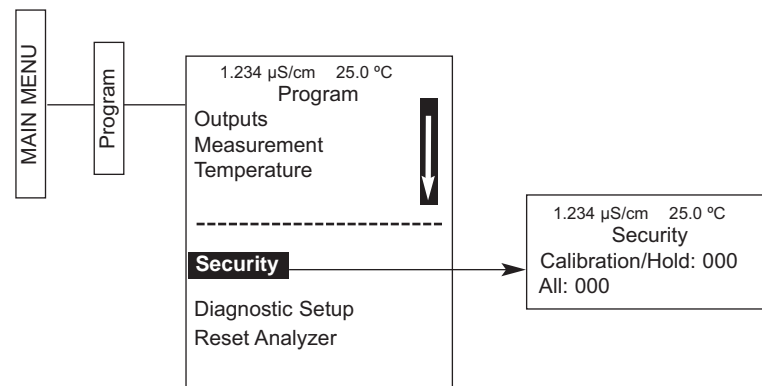

7.6 Security Access

7.6.1 How the Security Code Works

When entering the correct access code for the Calibration/Hold security level, the Calibration and Hold menus are accessible. This allows operators or technicians to perform routine maintenance. This security level does not allow access to the Program or Display menus. When entering the correct access code for All security level, the user has access to all menu functions, including Programming, Calibration, Hold and Display.

7.6.2 Procedure

1. If a security code has been programmed, selecting the Calibrate, Hold, Program or Display top menu items causes the security access screen to appear
2. Enter the three-digit security code for the appropriate security level.
3. If the entry is correct, the appropriate menu screen appears. If the entry is incorrect, the Invalid Code screen appears. The Enter Security Code screen reappears after 2 seconds.

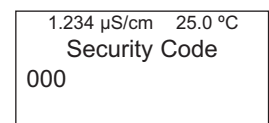

7.7 Using Hold

7.7.1 Purpose

The transmitter output is always proportional to measured value. To prevent improper operation of systems or pumps that are controlled directly by the current output, place the analyzer in hold before removing the sensor for calibration and maintenance. Be sure to remove the transmitter from hold once calibration is complete. During hold, both outputs remain at the last value. Once in hold, all current outputs remain on Hold indefinitely.

FIGURE 7-3. Using Hold

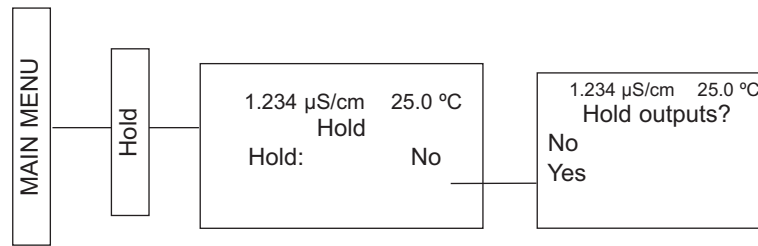

7.7.2 Using the Hold Function

To hold the outputs,

1. Press MENU. The main menu screen appears. Choose **Hold**.
2. The **Hold Outputs?** screen appears. Choose Yes to place the analyzer in hold. Choose **No** to take the analyzer out of hold.
3. The Hold screen will then appear and **Hold will remain on indefinitely until Hold is disabled**. See Figure 7-3.

7.8 Resetting Factory Default Settings

7.8.1 Purpose

This section describes how to restore factory calibration and default values. The process also clears all fault messages and returns the display to the first Quick Start screen. The 1066 offers three options for resetting factory defaults.

1. Reset all settings to factory defaults
2. Reset sensor calibration data only
3. Reset analog output settings only

7.8.2 Procedure

To reset to factory defaults, reset calibration data only or reset analog outputs only, follow the Reset Analyzer flow diagram.

FIGURE 7-4. Resetting Factory Default Settings

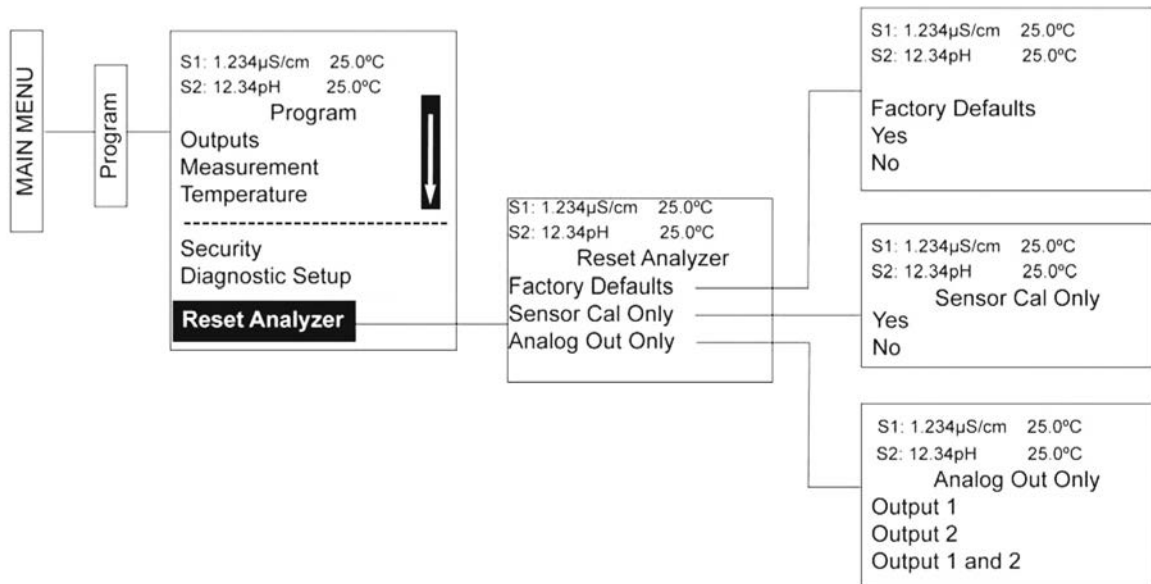

Section 8: Programming Measurements

8.1 Introduction

The 1066 automatically recognizes the measurement input upon first power-up and each time the transmitter is powered. Completion of Quick Start screens upon first power up enable measurements, but additional steps may be required to program the transmitter for the desired measurement application. This section covers the following programming and configuration functions:

1. Selecting measurement type or sensor type (all sections)
2. Identifying the preamp location (pH-see [Section 8.2](#))
3. Enabling manual temperature correction and entering a reference temperature (all sections)
4. Enabling sample temperature correction and entering temperature correction slope (selected sections)
5. Defining measurement display resolution (pH and amperometric)
6. Defining measurement display units (all sections)
7. Adjusting the input filter to control display and output reading variability or noise (all sections)
8. Selecting a measurement range (conductivity – see [Section 8.4, 8.5](#))
9. Entering a cell constant for a contacting or toroidal sensor (see [Section 8.4, 8.5](#))
10. Creating an application-specific concentration curve (conductivity-see [Section 8.4, 8.5](#))
11. Enabling automatic pH correction for free chlorine measurement ([Section 8.6.1](#))

To fully configure the transmitter, you may use the following:

1. Reset Transmitter function to reset factory defaults and configure to the desired measurement. Follow the Reset Transmitter menu to reconfigure the transmitter to display new measurements or measurement units.
2. Program menus to adjust any of the programmable configuration items. Use the following configuration and programming guidelines for the applicable measurement.

8.2 pH Measurement Programming

8.2.1 Description

The section describes how to configure the 1066 transmitter for pH measurements. The following programming and configuration functions are covered.

1. Measurement type: pH Select pH, ORP, Redox.
2. Preamp location: Transmitter Identify preamp location (automatic detection for SMART pH sensors)
3. Filter: 4 sec Override the default input filter, enter 0-999 seconds
4. Reference Z: Low Select low or high reference impedance
5. Resolution: 0.01pH Select 0.01pH or 0.1pH for pH display resolution

To configure pH:

1. Press **MENU**
2. Scroll down to **Program**. Press ENTER.
3. Scroll down to Measurement. Press ENTER.

The adjacent screen format will appear (factory defaults are shown). To program any function, scroll to the desired item and press ENTER.

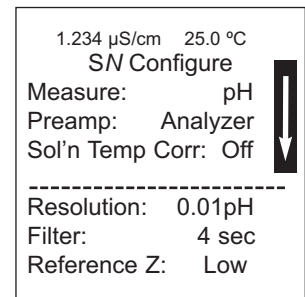

The following sub-sections provide you with the initial display screen that appears for each configuration function. Use the flow diagram for pH programming and the 1066 live screen prompts for each function to complete configuration and programming.

8.2.2 Measurement

The display screen for selecting the measurement is shown. The default value is displayed in bold type. Refer to the pH/ORP Programming flow diagram to complete this function.

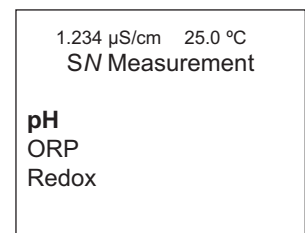

8.2.3 Preamp

The display screen for identifying the Preamp location is shown. The default value is displayed in bold type. Refer to the pH/ORP Programming flow diagram to complete this function.

Note: Sensor/JBox must be selected to support SMART pH sensors from Rosemount.

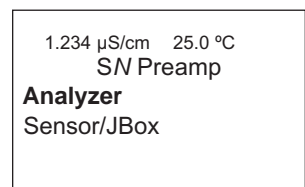

8.2.4 Solution Temperature Correction

The display screen for selecting the Solution temperature correction algorithm is shown. The default value is displayed in **bold type**. Refer to the pH/ORP Programming flow diagram to complete this function.

1.234 μ S/cm 25.0 °C
SN Sol'n Temp Corr.
Off
Ultra Pure Water
High pH
Custom

8.2.5 Temperature Coefficient

The display screen for entering the custom solution temperature coefficient is shown. The default value is displayed in **bold type**. Refer to the pH/ORP Programming flow diagram to complete this function.

1.234 μ S/cm 25.0°C
SN Sol'n Temp Coeff.
- 0.032pH/°C

8.2.6 Resolution

The display screen for selecting 0.01pH or 0.1pH for pH display resolution is shown. The default value is displayed in **bold type**. Refer to the pH/ORP Programming flow diagram to complete this function.

1.234 μ S/cm 25.0 °C
SN Resolution
0.01pH
0.1pH

8.2.7 Filter

The display screen for entering the input filter value in seconds is shown. The default value is displayed in **bold type**. Refer to the pH/ORP Programming flow diagram to complete this function.

1.234 μ S/cm 25.0 °C
SN Input filter
04 sec

8.2.8 Reference Impedance

The display screen for selecting Low or High Reference impedance is shown. The default value is displayed in **bold type**. Refer to the pH/ORP Programming flow diagram to complete this function.

1.234 μ S/cm 25.0 °C
SN Reference Z
Low
High

8.3 ORP Measurement Programming

The section describes how to configure the 1066 transmitter for ORP measurements. The following programming and configuration functions are covered:

1. Measurement type: pH Select pH, ORP, Redox.
2. Preamp location: Transmitter Identify preamp location
3. Filter: 4 sec Override the default input filter, enter 0-999 seconds
4. Reference Z: Low Select low or high reference impedance
5. Sensor wiring scheme: Normal or Reference to Ground

To configure ORP:

1. Press **MENU**
2. Scroll down to **Program**. Press ENTER.
3. Scroll down to **Measurement**. Press ENTER.

The adjacent screen format will appear (factory defaults are shown).

To program any displayed function, scroll to the desired item and press ENTER.

1.234 $\mu\text{S/cm}$	25.0 $^{\circ}\text{C}$
SN Configure	
Measure:	pH
Preamp:	Analyzer
Filter:	4 sec
Reference Z:	Low

The following sub-sections provide you with the initial display screen that appears for each configuration function. Use the **flow diagram for ORP programming** at the end of Sec. 6 and the 1066 live screen prompts for each function to complete configuration and programming.

8.3.1 Measurement

The display screen for selecting the measurement is shown. The default value is displayed in **bold type**. Refer to the pH/ORP Programming flow diagram to complete this function.

1.234 $\mu\text{S/cm}$	25.0 $^{\circ}\text{C}$
SN Measurement	
pH	
ORP	
Redox	

8.3.2 Preamp

The display screen for identifying the Preamp location is shown. The default value is displayed in **bold type**. Refer to the pH/ORP Programming flow diagram to complete this function.

1.234 $\mu\text{S/cm}$	25.0 $^{\circ}\text{C}$
SN Preamp	
Analyzer	
Sensor/JBox	

8.3.3 Filter

The display screen for entering the input filter value in seconds is shown. The default value is displayed in **bold type**. Refer to the pH/ORP Programming flow diagram to complete this function.

1.234 $\mu\text{S/cm}$	25.0 $^{\circ}\text{C}$
SN Input filter	
04 sec	

8.3.4 Reference Impedance

The display screen for Selecting Low or high Reference impedance is shown. The default value is displayed in **bold type**. Refer to the pH/ORP Programming flow diagram to complete this function.

1.234 $\mu\text{S/cm}$	25.0 $^{\circ}\text{C}$
SN Reference Z	
Low	
High	

8.4 Contacting Conductivity Measurement Programming

8.4.1 Description

The section describes how to configure the 1066 transmitter for conductivity measurements using contacting conductivity sensors. The following programming and configuration functions are covered.

1. Measure: Conductivity Select Conductivity, Resistivity, TDS, Salinity or % conc
2. Type: 2-Electrode Select 2-Electrode or 4-Electrode type sensors
3. Cell K: 1.00000/cm Enter the cell Constant for the sensor
4. Measurement units
5. Filter: 2 sec Override the default input filter, enter 0-999 seconds
6. Range: Auto Select measurement Auto-range or specific range
7. Temp Comp: Slope Select Temp Comp: Slope, Neutral Salt, Cation or Raw
8. Slope: 2.00% / °C Enter the linear temperature coefficient
9. Ref Temp: 25.0 °C Enter the Reference temp
10. Cal Factor: default=0.95000/cm Enter the Cal Factor for 4-Electrode sensors from the sensor tag

To configure the contacting conductivity:

1. Press MENU
2. Scroll down to Program. Press ENTER.
3. Scroll down to Measurement. Press ENTER.

The adjacent screen format will appear (factory defaults are shown). To program any displayed function, scroll to the desired item and press ENTER.

1.234 µS/cm	25.0 °C
SN Configure	
Type:	2-Electrode
Measure:	Cond
Range:	Auto
Cell K:	1.00000/cm
RTD Offset:	0.00 °C
RTD Slope:	0
Temp Comp:	Slope
Slope:	2.00% / °C
Ref Temp:	25.0 °C
Filter:	2 sec
Custom Setup	

The following sub-sections provide you with the initial display screen that appears for each configuration function. Use the flow diagram for contacting conductivity programming at the end of Section 8 and the 1066 live screen prompts for each function to complete configuration and programming.

8.4.2 Sensor Type

The display screen for selecting 2-Electrode or 4-Electrode type sensors is shown. The default value is displayed in bold type. Refer to the contacting conductivity Programming flow diagram to complete this function.

1.234 µS/cm	25.0 °C
SN Type	
2-Electrode	
4-Electrode	

8.4.3 Measure

The display screen for selecting the measurement is shown. The default value is displayed in bold type. Refer to the contacting conductivity Programming flow diagram to complete this function.

1.234 $\mu\text{S}/\text{cm}$ 25.0 $^{\circ}\text{C}$
 SN Measurement
Conductivity
 Resistivity
 TDS
 Salinity
 NaOH (0-12%)
 HCl (0-15%)
 Low H₂SO₄
 High H₂SO₄
 NaCl (0-20%)
 Custom Curve

8.4.4 Range

The display screen for Selecting Auto-ranging or a specific range is shown. The default value is displayed in bold type. Note: Ranges are shown as conductance, not conductivity. Refer to the contacting conductivity Programming flow diagram to complete this function.

1.234 $\mu\text{S}/\text{cm}$ 25.0 $^{\circ}\text{C}$
 SN Range
Auto
 50 μS
 500 μS
 2000 μS
 20 mS
 200 mS
 600 mS

8.4.5 Cell Constant

The display screen for entering a cell Constant for the sensor is shown. The default value is displayed in bold type. Refer to the contacting conductivity Programming flow diagram to complete this function.

1.234 $\mu\text{S}/\text{cm}$ 25.0 $^{\circ}\text{C}$
 SN Cell Constant
1.00000 /cm

8.4.6 RTD Offset

The display screen for Entering the RTD Offset for the sensor is shown. The default value is displayed in bold type. Refer to the contacting conductivity Programming flow diagram to complete this function.

1.234 $\mu\text{S}/\text{cm}$ 25.0 $^{\circ}\text{C}$
 SN RTD Offset
0.00 $^{\circ}\text{C}$

8.4.7 RTD Slope

The display screen for entering the RTD slope for the sensor is shown. The default value is displayed in bold type. Refer to the contacting conductivity Programming flow diagram to complete this function.

1.234 $\mu\text{S}/\text{cm}$ 25.0 $^{\circ}\text{C}$
 SN RTD Slope
2.00%/ $^{\circ}\text{C}$

8.4.8 Temp Comp

The display screen for Selecting Temperature Compensation as Slope, Neutral Salt, Cation or Raw is shown. The default value is displayed in bold type. Refer to the contacting conductivity Programming flow diagram to complete this function.

1.234 $\mu\text{S}/\text{cm}$ 25.0 $^{\circ}\text{C}$
 SN Temp Comp
Slope
 Neutral Salt
 Cation
 Raw

8.4.9 Slope

The display screen for Entering the conductivity/temp Slope is shown. The default value is displayed in bold type. Refer to the contacting conductivity Programming flow diagram to complete this function.

1.234 μ S/cm 25.0 °C
SN Slope
2.00 %/°C

8.4.10 Reference Temp

The display screen for manually entering the Reference temperature is shown. The default value is displayed in bold type. Refer to the contacting conductivity Programming flow diagram to complete this function.

1.234 μ S/cm 25.0 °C
SN Ref Temp
(25.0°C normal)
+25.0°C

8.4.11 Filter

The display screen for entering the input filter value in seconds is shown. The default value is displayed in bold type. Refer to the contacting conductivity Programming flow diagram to complete this function.

1.234 μ S/cm 25.0 °C
SN Input filter
02 sec

8.4.12 Custom Setup

The display screens for creating a custom curve for converting conductivity to concentration is shown. Refer to the contacting conductivity Programming flow diagram to complete this function.

1.234 μ S/cm 25.0°C
SN Custom Curve
Configure
Enter Data Points
Calculate Curve

When the custom curve data entry is complete, press ENTER. The display will confirm the determination of a custom curve fit to the entered data by displaying this screen:

1.234 μ S/cm 25.0 °C
SN Calculate Curve
Custom curve
fit completed.
In Process Cal
recommended.

If the custom curve fit is not completed or is unsuccessful, the display will read as follows and the screen will return to the beginning custom curve screen.

1.234 μ S/cm 25.0 °C
SN Calculate Curve
Failure

8.4.13 Cal Factor

Upon initial installation and power up, if 4-electrode was selected for the sensor type in the Quick Start menus, the user enters a Cell Constant and a “Cal Factor” using the instrument keypad. The cell constant is needed to convert measured conductance to conductivity as displayed on the transmitter screen. The “Cal Factor” entry is needed increase the accuracy of the live conductivity readings, especially at low conductivity readings below 20 μ S/cm. Both the Cell Constant and the “Cal Factor” are printed on the tag attached to the 4-electrode sensor/cable.

1.234 μ S/cm 25.0 °C
SN Cal Factor
0.95000/cm

8.5 Toroidal Conductivity Measurement Programming

8.5.1 Description

The section describes how to configure the 1066 transmitter for conductivity measurements using inductive/toroidal sensors. The following programming and configuration functions are covered:

1. Measure: Conductivity Select Conductivity, Resistivity, TDS, Salinity or % conc
2. Sensor Model: 228 Select sensor type
3. Measurement units
4. Range selection
5. Cell K: 3.00000/cm Enter the cell Constant for the sensors
6. Temp Comp: Slope Select Temp Comp: Slope, Neutral Salt, Cation or Raw
7. Slope: 2.00% / °C Enter the linear temperature coefficient
8. Ref Temp: 25.0 °C Enter the Reference temp
9. Filter: 2 sec Override the default input filter, enter 0-999 seconds

To configure toroidal conductivity:

1. Press MENU
2. Scroll down to Program. Press ENTER.
3. Scroll down to Measurement. Press ENTER.

The adjacent screen format will appear (factory defaults are shown). To program any displayed function, scroll to the desired item and press ENTER.

1.234 µS/cm	25.0 °C
SN Configure	
Model:	228
Measure:	Cond
Range:	Auto
Cell K: 3.00000/cm	
RTD Offset:	0.00 °C
RTD Slope:	0
Temp Comp:	Slope
Slope:	2.00% / °C
Ref Temp:	25.0 °C
Filter:	2 sec
Custom Setup	

The following sub-sections provide you with the initial display screen that appears for each configuration function. Use the flow diagram for toroidal conductivity programming at the end of Section 8 and the 1066 live screen prompts for each function to complete configuration and programming.

8.5.2 Sensor Type

The display screen for selecting the sensor model is shown. The default value is displayed in bold type. Refer to the toroidal conductivity Programming flow diagram to complete this function.

1.234 µS/cm	25.0 °C
SN Model	
228	
225	
226	
247	
Other	

8.5.3 Measure

The display screen for selecting the measurement is shown. The default value is displayed in bold type. Refer to the toroidal conductivity Programming flow diagram to complete this function.

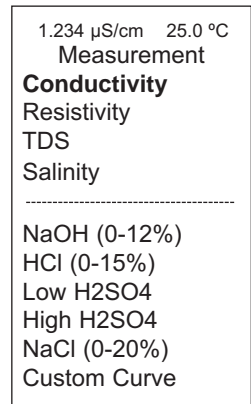

8.5.4 Range

The display screen for Selecting Auto-ranging or a specific range is shown. The default value is displayed in bold type. Note: Ranges are shown as conductance, not conductivity. Refer to the toroidal conductivity Programming flow diagram to complete this function.

NOTE: when manually changing ranges, a Zero calibration and recalibration in a solution of known conductivity must be performed with the toroidal sensor wired to the instrument. Refer to Section 9.5.2 Zeroing the Instrument and Section 9.5.3 Calibrating the Sensor in a Conductivity Standard.

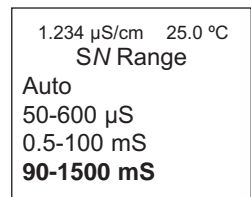

8.5.5 Cell Constant

The display screen for entering a cell Constant for the sensor is shown. The default value is displayed in bold type. Refer to the toroidal conductivity Programming flow diagram to complete this function.

NOTE: When manually changing ranges, the Cell Constant may change through the calibration process.

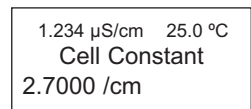

8.5.6 Temp Comp

The display screen for Selecting Temperature Compensation as Slope, Neutral Salt, or Raw is shown. The default value is displayed in bold type. Refer to the toroidal conductivity Programming flow diagram to complete this function.

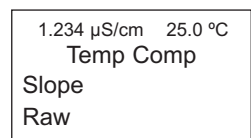

8.5.7 Slope

The display screen for Entering the conductivity/temp Slope is shown. The default value is displayed in bold type. Refer to the toroidal conductivity Programming flow diagram to complete this function.

```
1.234 μS/cm  25.0 °C
SN Slope
2.00%/°C
```

8.5.8 Ref Temp

The display screen for manually Entering the Reference temperature is shown. The default value is displayed in bold type. Refer to the toroidal conductivity Programming flow diagram to complete this function.

```
1.234 μS/cm  25.0 °C
SN Ref Temp
(25.0°C normal)
+25.0°C
```

8.5.9 Filter

The display screen for entering the input filter value in seconds is shown. The default value is displayed in bold type. Refer to the toroidal conductivity Programming flow diagram to complete this function.

```
1.234 μS/cm  25.0 °C
SN Input filter
```

02 sec

Using the highest range (90 mS to 1500 mS) in very low conductivity processes below 100 μS (conductance) might generate a high noise value relative to the actual process value. In these cases, it is recommended to increase the input filter setting above the default value of 2 sec. to suppress the effect of noise.

8.5.10 Custom Setup

The display screens for creating custom curves for converting conductivity to concentration is shown. Refer to the toroidal conductivity Programming flow diagram to complete this function.

```
1.234 μS/cm  25.0 °C
SN Custom Curve
Configure
Enter Data Points
Calculate Curve
```

When the custom curve data entry is complete, press ENTER. The display will confirm the determination of a custom curve fit to the entered data by displaying this screen:

```
1.234 μS/cm  25.0 °C
SN Calculate Curve
Custom curve
fit completed.
In Process Cal
recommended.
```

If the custom curve fit is not completed or is unsuccessful, the display will read as follows and the screen will return to the beginning custom curve screen.

```
1.234 μS/cm  25.0 °C
SN Calculate Curve
Failure
```

8.6 Chlorine Measurement Programming

The 1066 can measure any of three variants of Chlorine:

- Free Chlorine
- Total Chlorine
- Monochloramine

The section describes how to configure the 1066 transmitter for Chlorine measurements.

8.6.1 Free Chlorine Measurement Programming

This Chlorine sub-section describes how to configure the 1066 transmitter for Free Chlorine measurement using amperometric chlorine sensors. Automatic temperature compensation is available using Auto or Manual pH correction. For maximum accuracy, use automatic temperature compensation.

The following programming and configuration functions are covered:

1. Measure: Free Chlorine Select Free Chlorine, Total Cl, Monochloramine
2. Units: ppm Select units ppm or mg/L
3. Resolution: 0.001 Select display resolution 0.01 or 0.001
4. Free Cl Correct: Live Select Live/Continuous pH correction or Manual
5. Manual pH: 7.00 pH For Manual pH correction, enter the pH value
6. Filter: 5sec Override the default input filter, enter 0-999 seconds

To configure chlorine for free chlorine:

1. Press MENU
2. Scroll down to Program. Press ENTER.
3. Scroll down to Measurement. Press ENTER.

The adjacent screen format will appear (factory defaults are shown). To program any displayed function, scroll to the desired item and press ENTER.

1.234 μ S/cm	25.0 $^{\circ}$ C
SN Configure	
Measure: Free Chlorine	
Units: ppm	

Filter: 5sec	
Free Cl Correct: Live	
Manual pH: 7.00 pH	
Resolution: 0.001	

The following sub-sections provide you with the initial display screen that appears for each configuration function. Use the flow diagram for chlorine programming at the end of Sec. 8 and the 1066 live screen prompts for each function to complete configuration and programming.

8.6.1.1 Measure

The display screen for selecting the measurement is shown. The default value is displayed in bold type. Refer to the Chlorine Programming flow diagram to complete this function.

1.234 μ S/cm 25.0 °C
SN Measurement
Free Chlorine
Total Chlorine
Monochloramine

8.6.1.2 Units

The display screen for selecting units as ppm or mg/L is shown. The default value is displayed in bold type. Refer to the Chlorine Programming flow diagram to complete this function.

1.234 μ S/cm 25.0 °C
SN Units
ppm
mg/L

8.6.1.3 Filter

The display screen for entering the input filter value in seconds is shown. The default value is displayed in bold type. Refer to the Chlorine Programming flow diagram to complete this function.

1.234 μ S/cm 25.0 °C
SN Input filter
05 sec

8.6.1.4 Free Chlorine pH Correction

The display screen for Selecting Live/Continuous pH correction or Manual pH correction is shown. The default value is displayed in bold type. Refer to the Chlorine Programming flow diagram to complete this function.

1.234 μ S/cm 25.0 °C
SN Free Cl
pH Correction
Live/Continuous
Manual

8.6.1.5 Manual pH Correction

The display screen for manually entering the pH value of the measured process liquid is shown. The default value is displayed in bold type. Refer to the Chlorine Programming flow diagram to complete this function.

1.234 μ S/cm 25.0 °C
SN Manual pH
07.00 pH

8.6.1.6 Resolution

The display screen for selecting display resolution as 0.001 or 0.01 is shown. The default value is displayed in bold type. Refer to the Chlorine Programming flow diagram to complete this function.

1.234 μ S/cm 25.0 °C
SN Resolution -
0.001
0.01

8.6.2 Total Chlorine Measurement Programming

8.6.2.1 Description

This Chlorine sub-section describes how to configure the 1066 transmitter for Total Chlorine measurement using amperometric chlorine sensors. The following programming and configuration functions are covered:

1. Measure: Free Chlorine Select Free Chlorine, pH Ind. Free Cl. Total Cl, Monochloramine
2. Units: ppm Select units ppm or mg/L
3. Resolution: 0.001 Select display resolution 0.01 or 0.001
4. Filter: 5sec Override the default input filter, enter 0-999 seconds

To configure chlorine measurement for total chlorine:

1. Press MENU
2. Scroll down to Program. Press ENTER.
3. Scroll down to Measurement. Press ENTER.

1.234 μ S/cm	25.0 °C
SN Configure	
Measure: Free Chlorine	
Units:	ppm
Filter:	5sec
Resolution:	0.001

The adjacent screen format will appear (factory defaults are shown). To program any displayed function, scroll to the desired item and press ENTER.

The following sub-sections provide you with the initial display screen that appears for each configuration function. Use the flow diagram for chlorine programming at the end of Sec. 6 and the 1066 live screen prompts for each function to complete configuration and programming.

8.6.2.2 Measure

The display screen for selecting the measurement is shown. The default value is displayed in bold type. Refer to the chlorine Programming flow diagram to complete this function.

1.234 μ S/cm	25.0 °C
SN Measurement	
Free Chlorine	
Total Chlorine	
Monochloramine	

8.6.2.3 Units

The display screen for selecting units as ppm or mg/L is shown. The default value is displayed in bold type. Refer to the Chlorine Programming flow diagram to complete this function

1.234 μ S/cm	25.0 °C
SN Units	
ppm	
mg/L	

8.6.2.4 Filter

The display screen for entering the input filter value in seconds is shown. The default value is displayed in bold type. Refer to the Chlorine Programming flow diagram to complete this function.

1.234 μ S/cm	25.0 °C
SN Input filter	
05 sec	

8.6.2.5 Resolution

The display screen for selecting display resolution as 0.001 or 0.01 is shown. The default value is displayed in bold type. Refer to the Chlorine Programming flow diagram to complete this function.

1.234 $\mu\text{S}/\text{cm}$	25.0 $^{\circ}\text{C}$
SN Resolution	
0.001	
0.01	

8.6.3 Monochloramine Measurement Programming

This Chlorine sub-section describes how to configure the 1066 transmitter for Monochloramine measurement using amperometric chlorine sensors. The following programming and configuration functions are covered:

1. Measure: Free Chlorine Select Free Chlorine, pH Ind. Free Cl. Total Cl, Monochloramine
2. Units: ppm Select units ppm or mg/L
3. Resolution: 0.001 Select display resolution 0.01 or 0.001
4. Filter: 5 sec Override the default input filter, enter 0-999 seconds

To configure chlorine for monochloramine:

1. Press MENU
2. Scroll down to Program. Press ENTER.
3. Scroll down to Measurement. Press ENTER.

1.234 $\mu\text{S}/\text{cm}$	25.0 $^{\circ}\text{C}$
SN Configure	
Measure: Free Chlorine	
Units:	ppm
Filter:	5 sec
Resolution:	0.001

The following screen format will appear (factory defaults are shown). To program any displayed function, scroll to the desired item and press ENTER.

The following sub-sections provide you with the initial display screen that appears for each configuration function. Use the flow diagram for chlorine programming at the end of Sec. 8 and the 1066 live screen prompts for each function to complete configuration and programming.

8.6.3.1 Measure: Monochloramine

The display screen for selecting the measurement is shown. The default value is displayed in bold type. Refer to the Chlorine Programming flow diagram to complete this function.

1.234 $\mu\text{S}/\text{cm}$	25.0 $^{\circ}\text{C}$
SN Measurement	
Free Chlorine	
Total Chlorine	
Monochloramine	

8.6.3.2 Units

The display screen for selecting units as ppm or mg/L is shown. The default value is displayed in bold type. Refer to the Chlorine Programming flow diagram to complete this function.

1.234 $\mu\text{S}/\text{cm}$	25.0 $^{\circ}\text{C}$
SN Units	
ppm	
mg/L	

8.6.3.3 Filter

The display screen for entering the input filter value in seconds is shown. The default value is displayed in bold type. Refer to the Chlorine Programming flow diagram to complete this function.



8.6.3.4 Resolution

The display screen for selecting display resolution as 0.001 or 0.01 is shown. The default value is displayed in bold type. Refer to the Chlorine Programming flow diagram to complete this function.

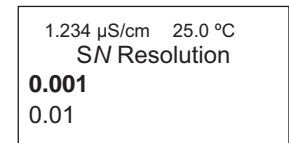

8.7 Oxygen Measurement Programming

This section describes how to configure the 1066 transmitter for dissolved and gaseous oxygen measurement using amperometric oxygen sensors. The following programming and configuration functions are covered:

1. Sensor type: Select Water/Waste, Trace, BioRx, BioRx-Other, Brew, %O₂ In Gas
2. Measure type: Select Concentration, % Saturation, Partial Pressure, Oxygen in Gas
3. Units: ppm Select ppm, mg/L, ppb, g/L, % Sat, %O₂-Gas, ppm Oxygen-Gas
4. Pressure Units: bar Select pressure units: mm Hg, in Hg, Atm, kPa, mbar, bar
5. Salinity: 00.0 %. Enter Salinity as %.
6. Filter: 5 sec Override the default input filter, enter 0-999 seconds
7. Partial Press: mmHg Select mm Hg, in Hg, atm, kPa, mbar or bar for Partial pressure

To configure Oxygen:

1. Press MENU
2. Scroll down to Program. Press ENTER.
3. Scroll down to Measurement. Press ENTER.

The adjacent screen format will appear (factory defaults are shown). To program any displayed function, scroll to the desired item and press ENTER.

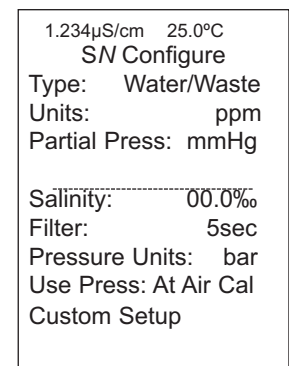

The following sub-sections show the initial display screen that appears for each configuration function. Use the flow diagram for oxygen programming at the end of Sec. 6 and the 1066 live screen prompts for each function to complete configuration and programming.

8.7.1 Oxygen Measurement application

The display screen for programming the measurement is shown. The default value is displayed in bold type. Refer to the Oxygen Programming flow diagram to complete this function.

1.234 $\mu\text{S/cm}$ 25.0 $^{\circ}\text{C}$
SN Type
Water/Waste
Trace Oxygen
BioRx-Rosemount
BioRx-Other

Brewing
Oxygen In Gas

8.7.2 Units

The display screen for selecting units as ppm , mg/L, ppb, $\mu\text{g/L}$, % Saturation, %Oxygen in Gas, or ppm Oxygen in Gas is shown. The default value is displayed in bold type. Refer to the Oxygen Programming flow diagram to complete this function.

1.234 $\mu\text{S/cm}$ 25.0 $^{\circ}\text{C}$
SN Units
ppm
mg/L
ppb
 $\mu\text{g/L}$

% Saturation
Partial Pressure
% Oxygen In Gas
ppm Oxygen In Gas

8.7.3 Partial Press

The display screen for selecting pressure units for Partial pressure is shown. This selection is needed if the specified measurement is Partial pressure. The default value is displayed in bold type. Refer to the Oxygen Programming flow diagram to complete this function.

1.234 $\mu\text{S/cm}$ 25.0 $^{\circ}\text{C}$
SN Partial Press
mm Hg
in Hg
atm
kPa

mbar
bar

8.7.4 Salinity

The display screen for Entering the Salinity (as parts per thousand) of the process liquid to be measured is shown. The default value is displayed in bold type. Refer to the Oxygen Programming flow diagram to complete this function.

1.234 $\mu\text{S/cm}$ 25.0 $^{\circ}\text{C}$
SN Salinity
00.0 ‰

Enter Salinity as ‰

8.7.5 Filter

The display screen for entering the input filter value in seconds is shown. The default value is displayed in bold type. Refer to the Oxygen Programming flow diagram to complete this function.

1.234 $\mu\text{S/cm}$ 25.0 $^{\circ}\text{C}$
SN Input filter
05 sec

8.7.6 Pressure Units

The display screen for selecting pressure units for atmospheric pressure is shown. This selection is needed for the display of atmospheric pressure. The default value is displayed in bold type. The user must enter a known value for local atmospheric pressure. Refer to the Oxygen Programming flow diagram to complete this function.

1.234 $\mu\text{S/cm}$ 25.0 $^{\circ}\text{C}$
Pressure Units
mm Hg
in Hg
atm
kPa

mbar
bar

8.8 Ozone Measurement Programming

This section describes how to configure the 1066 transmitter for ozone measurement using amperometric ozone sensors. The following programming and configuration functions are covered:

1. Units: ppm Select ppm, mg/L, ppb, $\mu\text{g/L}$
2. Resolution: 0.001 Select display resolution 0.01 or 0.001
3. Filter: 5sec Override the default input filter, enter 0-999 seconds

To configure Ozone:

1. Press MENU
2. Scroll down to Program. Press ENTER.
3. Scroll down to Measurement. Press ENTER.

1.234 $\mu\text{S/cm}$	25.0 $^{\circ}\text{C}$
SN Configure	
Units:	ppm
Filter:	5 sec
Resolution:	0.001

The adjacent screen format will appear (factory defaults are shown). To program any displayed function, scroll to the desired item and press ENTER.

The following sub-sections show the initial display screen that appears for each configuration function. Use the flow diagram for ozone programming at the end of Sec. 6 and the 1066 live screen prompts for each function to complete configuration and programming.

Note: Ozone measurement boards are detected automatically by the analyzer. No measurement selection is necessary.

8.8.1 Units

The display screen for selecting measurement units is shown. The default value is displayed in bold type. Refer to the Ozone Programming flow diagram to complete this function.

1.234 $\mu\text{S/cm}$	25.0 $^{\circ}\text{C}$
SN Units	
ppm	
mg/L	
ppb	
$\mu\text{g/L}$	

8.8.2 Filter

The display screen for entering the input filter value in seconds is shown. The default value is displayed in bold type. Refer to the Ozone Programming flow diagram to complete this function.

1.234 $\mu\text{S/cm}$	25.0 $^{\circ}\text{C}$
SN Input filter	
05 sec	

8.8.3 Resolution

The display screen for selecting display resolution as 0.001 or 0.01 is shown. The default value is displayed in bold type. Refer to the Ozone Programming flow diagram to complete this function.

1.234 $\mu\text{S/cm}$	25.0 $^{\circ}\text{C}$
SN Resolution	
0.001	
0.01	

FIGURE 8-1. Configuring pH/ORP Measurements

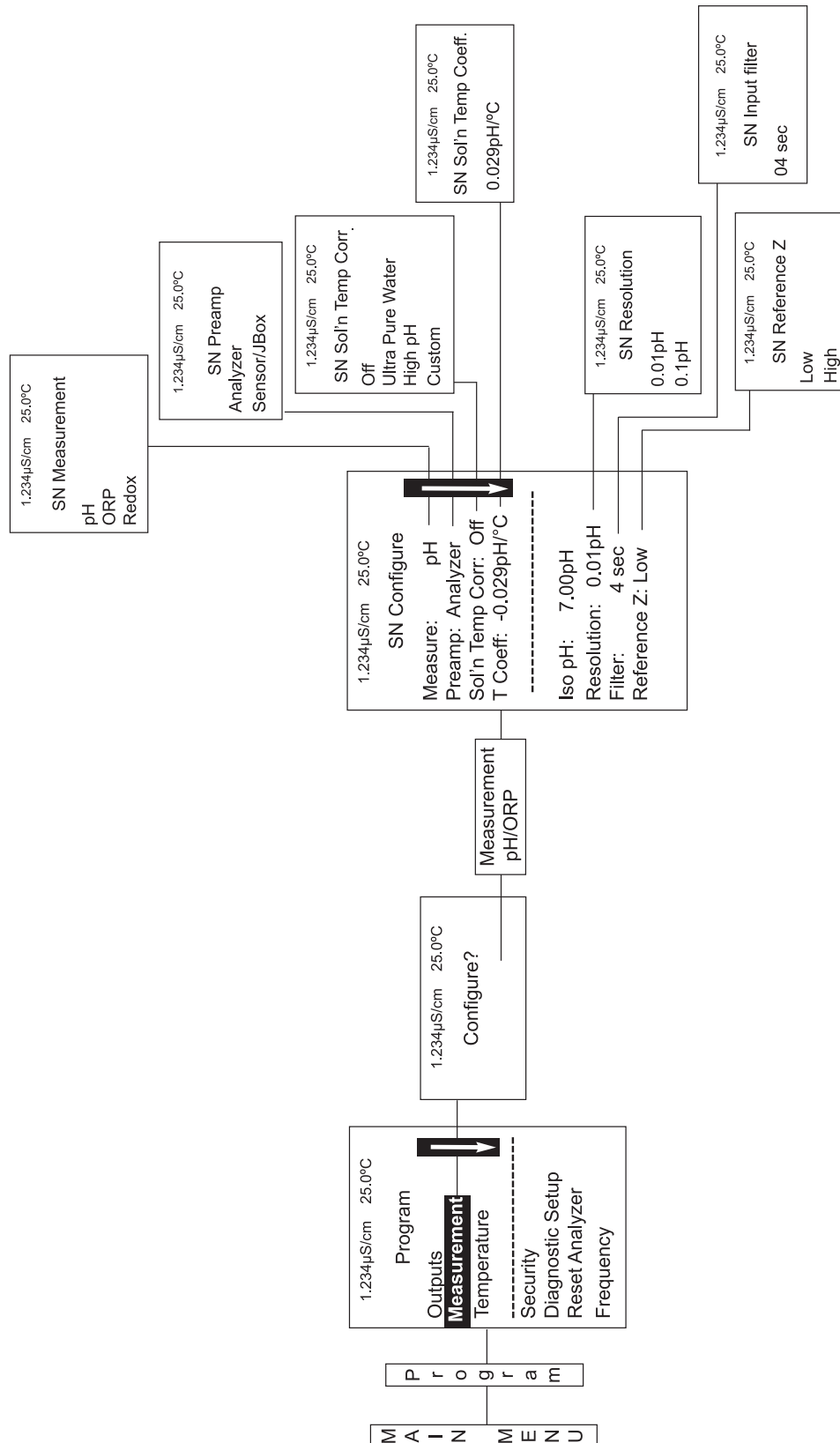

Figure 8-2. Configure Contacting Measurements

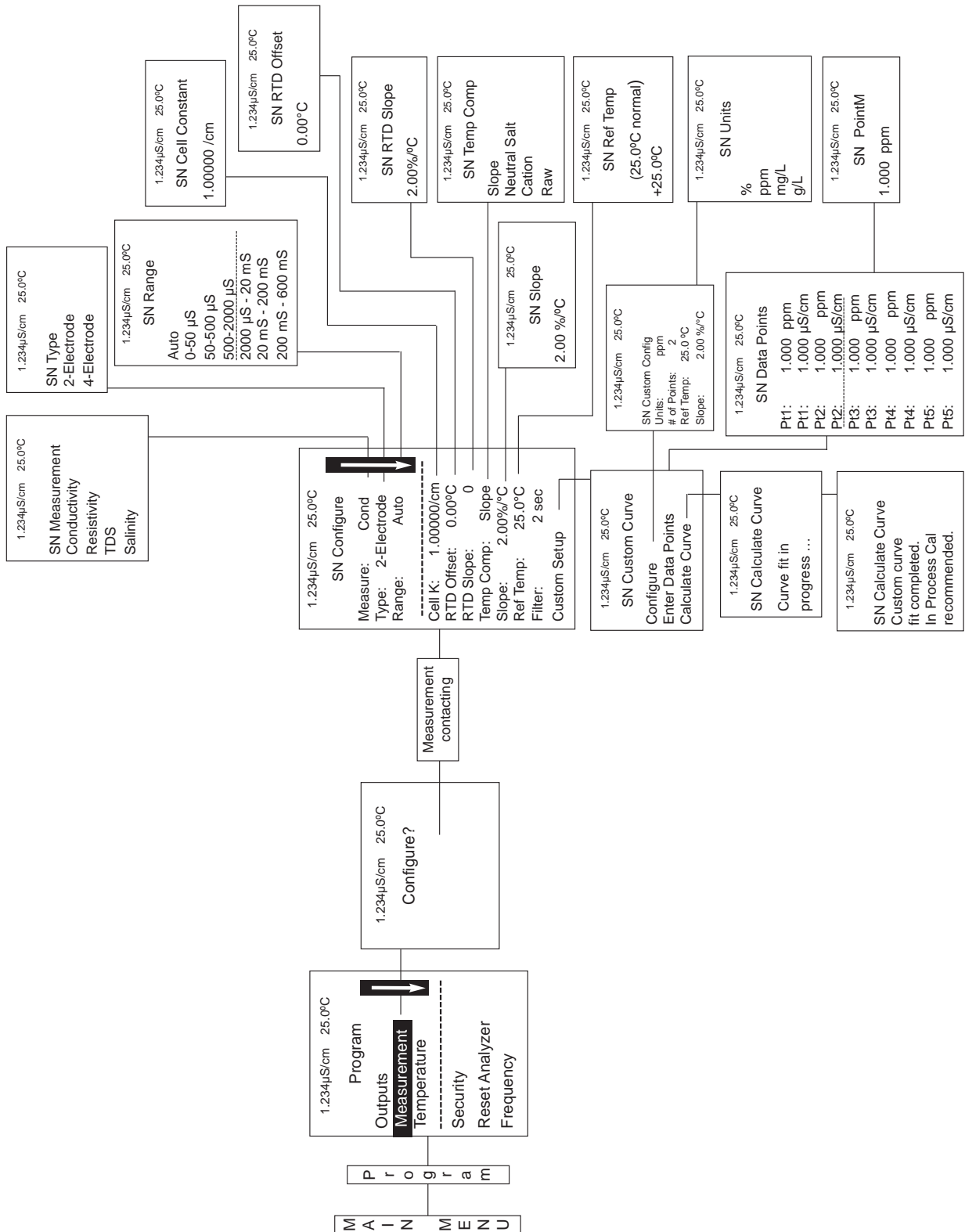

Figure 8-3. Configure Toroidal Measurements

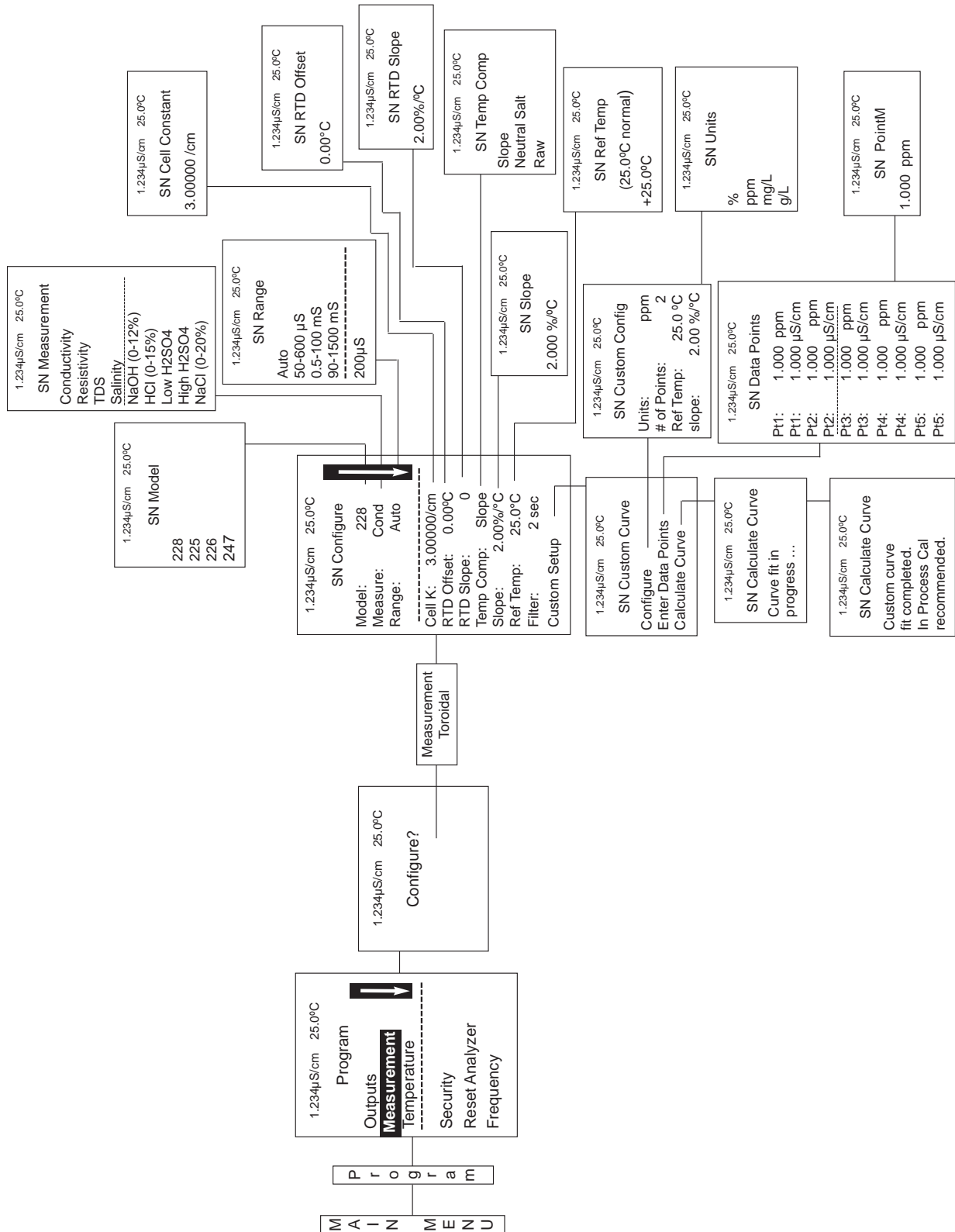

Figure 8-4. Configure Oxygen Measurements

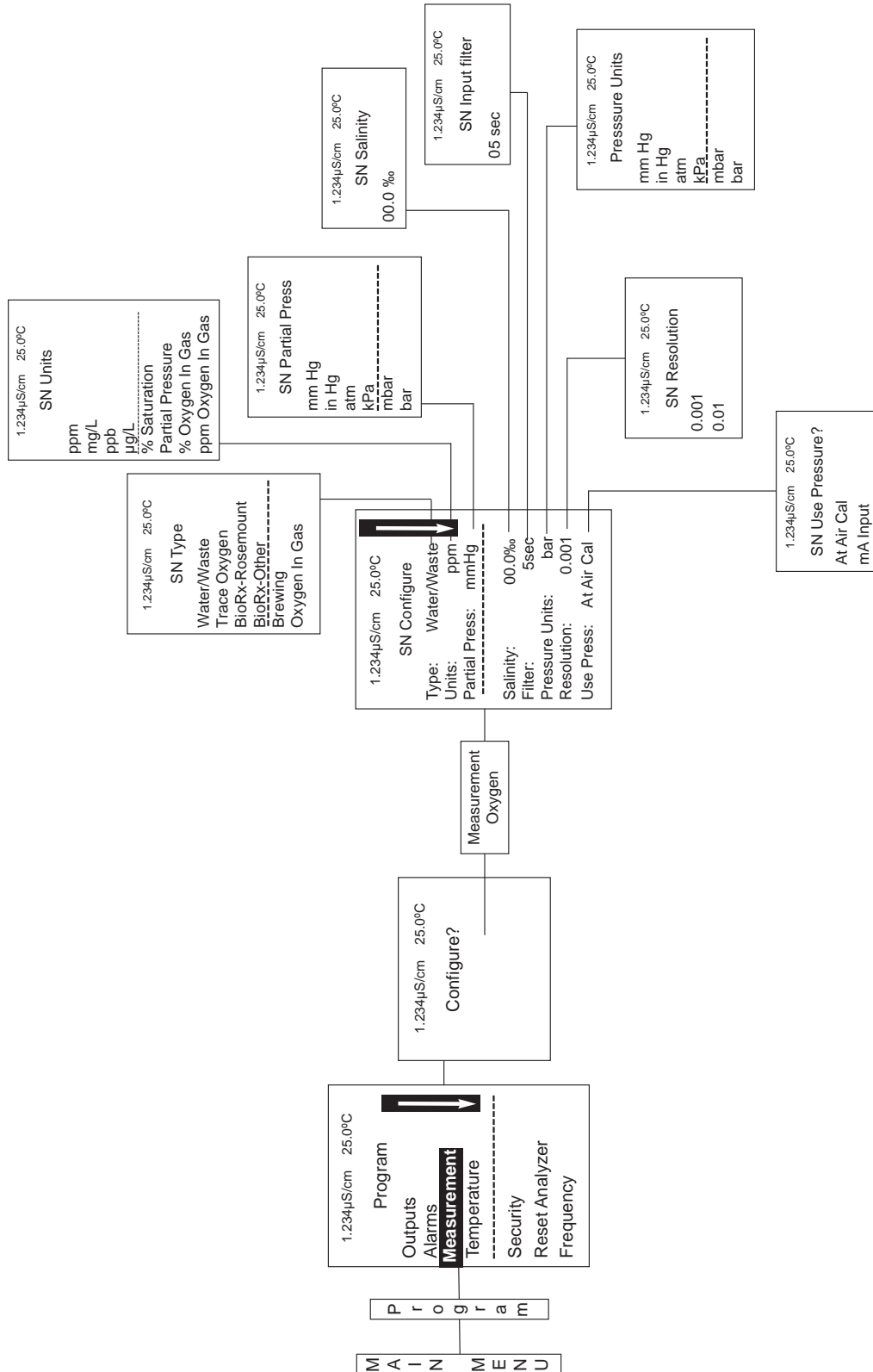

FIGURE 8-5. Configuring Chlorine Measurements

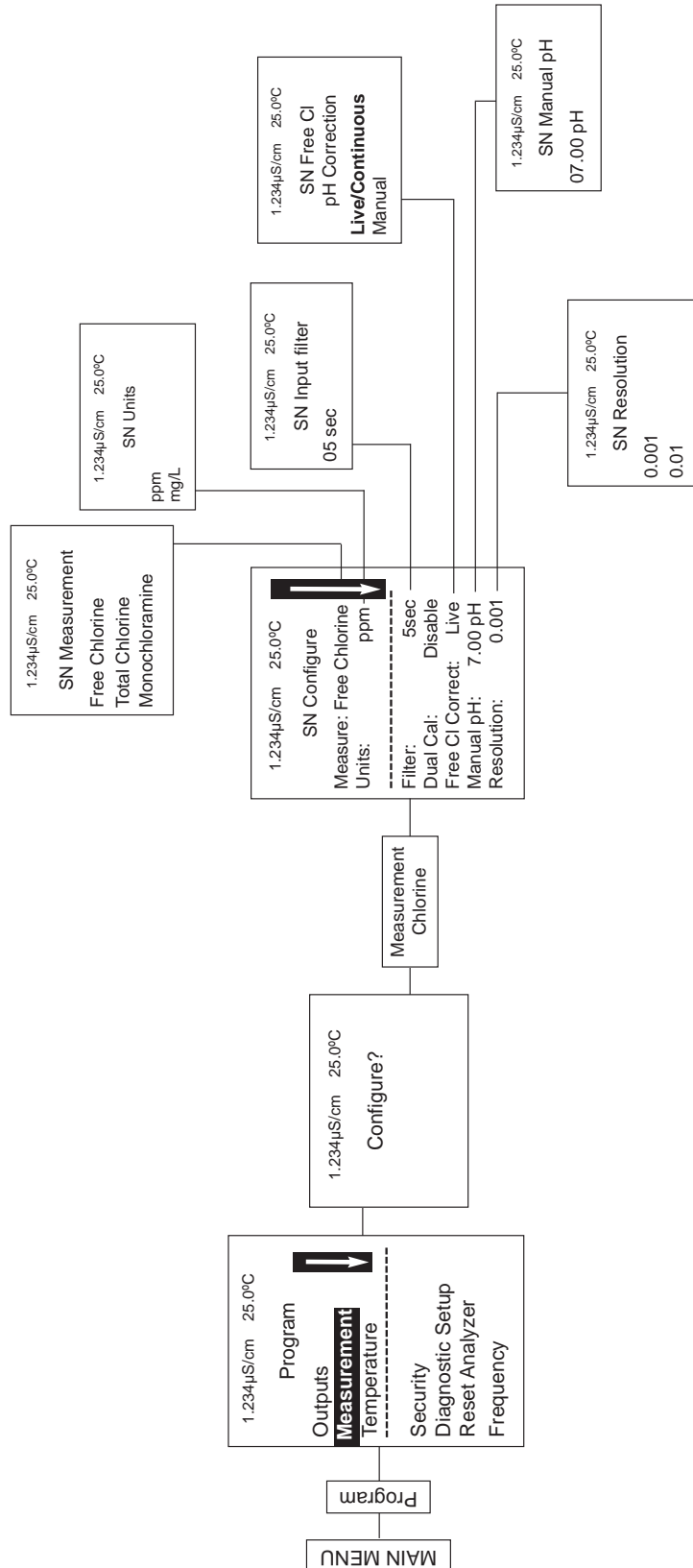
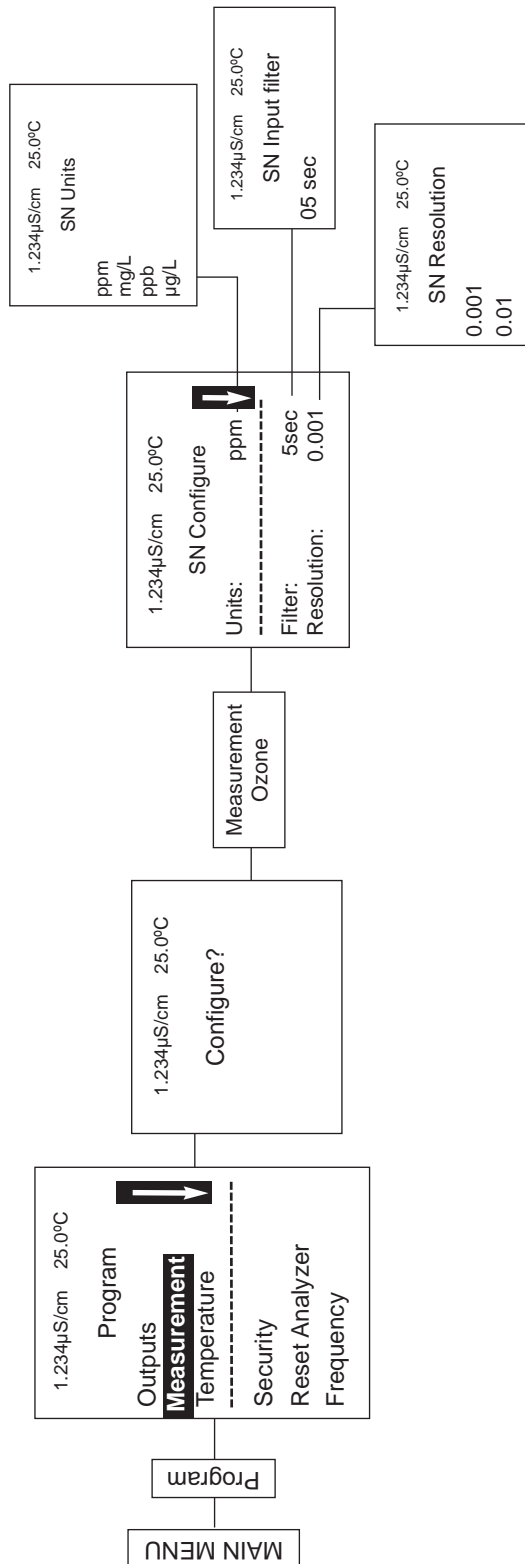

FIGURE 8-5. Configuring Ozone Measurements



Section 9: Calibration

9.1 Introduction

Calibration is the process of adjusting or standardizing the transmitter to a lab test or a calibrated laboratory instrument, or standardizing to some known reference (such as a commercial buffer). The auto-recognition feature of the transmitter will enable the appropriate calibration screens to allow calibration for any configuration of the transmitter. Completion of Quick Start upon first power up enables live measurements but does not ensure accurate readings in the lab or in process. Calibration should be performed with each attached sensor to ensure accurate, repeatable readings.

This section covers the following calibration functions:

1. Auto buffer cal for pH (pH Cal - [Section 9.2](#))
2. Manual buffer cal for pH (pH Cal - [Section 9.2](#))
3. Set calibration stabilization criteria for pH (pH Cal - [Section 9.2](#))
4. Standardization calibration (1-point) for pH, ORP and Redox (pH Cal - [Section 9.2](#) and [9.3](#))
5. SMART sensor auto calibration upload

9.2 Calibration

New sensors must be calibrated before use. Regular recalibration is also necessary. Use auto calibration instead of manual calibration. Auto calibration avoids common pitfalls and reduces errors. The transmitter recognizes the buffers and uses temperature-corrected pH values in the calibration. Once the 1066 successfully completes the calibration, it calculates and displays the calibration slope and offset. The slope is reported as the slope at 25 °C.

To calibrate the pH loop with a connected pH sensor, access the Calibration screen by pressing ENTER from the main screen and press ENTER.

The following calibration routines are covered:

1. Auto Calibration - pH 2 point buffer calibration with auto buffer recognition
2. Manual Calibration - pH 2 point buffer calibration with manual buffer value entry
3. Standardization - pH 1 point buffer calibration with manual buffer value entry
4. Entering A Known Slope Value - pH Slope calibration with manual entry of known slope value
5. SMART sensor auto calibration – auto detection and upload of cal data

To calibrate pH:

1. Press the **MENU** button
2. Select Calibrate. Press **ENTER**.
3. Select **pH**. Press ENTER.

The following sub-sections show the initial display screen that appears for each calibration routine. Use the **flow diagram for pH calibration** at the end of [Section 7](#) and the live screen prompts to complete calibration.

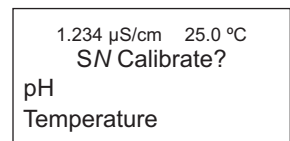

9.2.1 Auto Calibration

This screen appears after selecting **pH calibration**.

```

1.234 µS/cm  25.0 °C
  SN pH Cal
Buffer Cal
Standardize
Slope:    59.16mV/pH
Offset:    600 mV
  
```

Note that pH auto calibration criteria can be changed. The following criteria can be adjusted:

- Stabilization time (default 10 sec.)
- Stabilization pH value (default 0.02 pH)
- Type of Buffer used for AUTO CALIBRATION (default is Standard, non-commercial buffers).

The following commercial buffer tables are recognized by the analyzer:

- Standard (NIST plus pH7)
- DIN 19267
- Ingold
- Merck

```

1.234 µS/cm  25.0 °C
  SN Setup
Stable Time:  10 sec
Stable Delta: 0.02 pH
Buffer:       Standard
  
```

This screen will appear if the auto cal is successful. The screen will return to the pH Buffer Cal Menu.

```

1.234 µS/cm  25.0 °C
  SN pH Auto Cal
Slope: 59.16 mV/pH
Offset: 60 mV
  
```

The following screens may appear if the auto cal is unsuccessful.

1. A High Slope Error will generate this screen display:

```

1.234 µS/cm  25.0°C
  SN pH Auto Cal
High Slope Error
Calculated: 62.11 mV/pH
Max: 62.00 mV/pH
Press EXIT
  
```

2. A Low Slope Error will generate this screen display:

```

1.234 µS/cm  25.0 °C
  SN pH Auto Cal
Low Slope Error
Calculated: 39.11mV/pH
Min: 40.00 mV/pH
Press EXIT
  
```

3. An Offset Error will generate this screen display:

```

1.234 µS/cm  25.0 °C
  SN pH Auto Cal
Offset Error
Calculated: 61.22mV
Max: 60.00mV
Press EXIT
  
```

9.2.2 Manual Calibration – pH

New sensors must be calibrated before use. Regular recalibration is also necessary. Use manual calibration if non-standard buffers are being used; otherwise, use auto calibration. Auto calibration avoids common pitfalls and reduces errors. The adjacent appears after selecting Manual pH calibration.

```
1.234 µS/cm  25.0 °C
SN pH Manual Cal
Buffer 1
Buffer 2
```

9.2.3 Entering a Known Slope Value – pH

If the electrode slope is known from other measurements, it can be entered directly in the 1066 transmitter. The slope must be entered as the slope at 25 °C.

```
1.234 µS/cm  25.0 °C
SN pH Slope@25°C
59.16 mV/pH
```

9.2.4 Standardization – pH

The pH measured by the 1066 transmitter can be hanged to match the reading from a second or referee instrument. The process of making the two readings agree is called standardization. During standardization, the difference between the two pH values is converted to the equivalent voltage. The voltage, called the reference offset, is added to all subsequent measured cell voltages before they are converted to pH. If a standardized sensor is placed in a buffer solution, the measured pH will differ from the buffer pH by an amount equivalent to the standardization offset.

```
1.234 µS/cm  25.0 °C
SN Enter Value
07.00pH
```

This screen may appear if pH Cal is unsuccessful. An Offset Error will generate this screen display:

```
1.234 µS/cm  25.0 °C
SN Standardize
Offset Error
Calculated:  96mV
Max:        60mV
Press EXIT
```

If the pH Cal is successful, the screen will return to the Cal sub-menu.

9.2.5 SMART sensor auto calibration upload – pH

All calibration data including slope (mV/pH unit), offset (mV), glass impedance (MegOhms), and reference impedance (kOhms) is automatically downloaded to the SMART sensor upon successful calibration. This data transfer to the sensor is transparent and does not require any user action. Calibrated SMART sensors will be loop-calibrated when wired or attached (via VP8 cable connection) to any SMART-enabled Rosemount instrument.

To calibrate any SMART sensor, choose any available calibration method. Note that new SMART sensors upon first shipment from Emerson are pre-calibrated and do not require buffer calibration or standardization to be used in process immediately.

9.3 ORP and Redox Calibration

For process control, it is often important to make the measured ORP or Redox agree with the ORP or Redox of a standard solution. During calibration, the measured ORP or Redox is made equal to the ORP or Redox of a standard solution at a single point.

To calibrate the ORP loop with a connected ORP sensor, access the Calibration screen by pressing ENTER from the main screen and press ENTER.

The following calibration routine is covered:

1. Standardization ORP 1 point buffer calibration with manual buffer value entry.

To calibrate ORP:

1. Press the MENU button.
2. Select Calibrate. Press ENTER.
3. Select ORP and Redox. Press ENTER.

1.234 $\mu\text{S}/\text{cm}$	25.0 $^{\circ}\text{C}$
SN Calibrate?	
ORP	
Temperature	

The following sub-sections show the initial display screen that appears for each calibration routine. Use the **flow diagram for ORP calibration** at the end of [Section 8](#) and the live screen prompts to complete calibration.

9.3.1 Standardization – ORP and Redox

For process control, it is often important to make the measured ORP and Redox agree with the ORP and Redox of a standard solution. During calibration, the measured ORP and Redox is made equal to the ORP and Redox of a standard solution at a single point. This screen appears after selecting ORP and Redox calibration:

1.234 $\mu\text{S}/\text{cm}$	25.0 $^{\circ}\text{C}$
SN Enter Value	
+0600 mV	

If the ORP and Redox Cal is successful, the screen will return to the Cal sub-menu.

The following screen may appear if ORP and Redox Cal is unsuccessful.

1.234 $\mu\text{S}/\text{cm}$	25.0 $^{\circ}\text{C}$
SN Standardize	
Offset Error	
Calculated:	61.22mV
Max:	60.00mV
Press EXIT	

9.4 Contacting Conductivity Calibration

New conductivity sensors rarely need calibration. The cell constant printed on the label is sufficiently accurate for most applications.

CALIBRATING AN IN-SERVICE CONDUCTIVITY SENSOR

After a conductivity sensor has been in service for a period of time, recalibration may be necessary. There are three ways to calibrate a sensor.

- a. Use a standard instrument and sensor to measure the conductivity of the process stream. It is not necessary to remove the sensor from the process piping. The temperature correction used by the standard instrument may not exactly match the temperature correction used by the 1066. To avoid errors, turn off temperature correction in both the transmitter and the standard instrument.
- b. Place the sensor in a solution of known conductivity and make the transmitter reading match the conductivity of the standard solution. Use this method if the sensor can be easily removed from the process piping and a standard is available. Be careful using standard solutions having conductivity less than 100 $\mu\text{S}/\text{cm}$. Low conductivity standards are highly susceptible to atmospheric contamination. Avoid calibrating sensors with 0.01/cm cell constants against conductivity standards having conductivity greater than 100 $\mu\text{S}/\text{cm}$. The resistance of these solutions may be too low for an accurate measurement. Calibrate sensors with 0.01/cm cell constant using method c.
- c. To calibrate a 0.01/cm sensor, check it against a standard instrument and 0.01/cm sensor while both sensors are measuring water having a conductivity between 5 and 10 $\mu\text{S}/\text{cm}$. To avoid drift caused by absorption of atmospheric carbon dioxide, saturate the sample with air before making the measurements. To ensure adequate flow past the sensor during calibration, take the sample downstream from the sensor. For best results, use a flow-through standard cell. If the process temperature is much different from ambient, keep connecting lines short and insulate the flow cell.

To calibrate the conductivity loop with a connected contacting conductivity sensor, access the Calibration screen by pressing ENTER from the main screen and press ENTER.

The following calibration routines are covered:

1. Zero Cal Zero the transmitter with the sensor attached
2. In Process Cal Standardize the sensor to a known conductivity
3. Cell K: 1.00000/cm Enter the cell Constant for the sensor
4. Meter Cal Calibrate the transmitter to a lab conductivity instrument
5. Cal Factor: 0.95000/cm Enter the Cal Factor for 4-Electrode sensors from the sensor tag

To calibrate contacting conductivity:

1. Press the MENU button
2. Select Calibrate. Press ENTER.
3. Select Conductivity. Press ENTER.

1.234 $\mu\text{S}/\text{cm}$ 25.0 $^{\circ}\text{C}$ SN Calibrate? Conductivity Temperature

The adjacent screen will appear. To calibrate Conductivity or Temperature, scroll to the desired item and press ENTER.

The following sub-sections show the initial display screen that appears for each calibration routine. Use the flow diagram for Conductivity calibration at the end of [Section 7](#) and the live screen prompts for each routine to complete calibration.

The adjacent screen appears after selecting Conductivity calibration:

```
1.234 µS/cm  25.0 °C
SN Calibration
Zero Cal
In Process Cal
Meter Cal
Cell K:  1.00000/cm
```

9.4.1 Entering the Cell Constant

New conductivity sensors rarely need calibration. The cell constant printed on the label is sufficiently accurate for most applications. The cell constant should be entered:

- When the unit is installed for the first time
- When the probe is replaced

The display screen for entering a cell Constant for the sensor is shown. The default value is displayed in bold type.

```
1.234 µS/cm  25.0 °C
SN Cell Constant
1.00000 /cm
```

9.4.2 Zeroing the Instrument

This procedure is used to compensate for small offsets to the conductivity signal that are present even when there is no conductivity to be measured. This procedure is affected by the length of extension cable and should always be repeated if any changes in extension cable or sensor have been made. Electrically connect the conductivity probe as it will actually be used and place the measuring portion of the probe in air. Be sure the probe is dry.

The adjacent screen will appear after selecting Zero Cal from the Conductivity Calibration screen:

The adjacent screen will appear if zero Cal is successful. The screen will return to the conductivity Cal Menu.

The adjacent screen may appear if zero Cal is unsuccessful.

```
1.234 µS/cm  25.0 °C
SN Zero Cal
In Air
In Water
```

```
1.234 µS/cm  25.0 °C
SN Zero Cal
Sensor Zero Done
```

```
1.234 µS/cm  25.0 °C
SN Zero Cal
Sensor Zero Fail
Offset too high

Press EXIT
```

9.4.3 Calibrating the Sensor in a Conductivity Standard (in process cal)

This procedure is used to calibrate the sensor and transmitter against a solution of known conductivity. This is done by submerging the probe in the sample of known conductivity, then adjusting the displayed value, if necessary, to correspond to the conductivity value of the sample. Turn temperature correction off and use the conductivity of the standard. Use a calibrated thermometer to measure temperature. The probe must be cleaned before performing this procedure.

The adjacent screen will appear after selecting In Process Cal from the Conductivity Calibration screen:

The adjacent screen will appear if In Process Cal is successful. The screen will return to the conductivity Cal Menu.

The adjacent screen may appear if In Process Cal is unsuccessful. The screen will return to the conductivity Cal Menu.

```
1.234 µS/cm  25.0 °C
SN InProcess Cal
Wait for stable
reading.
```

The adjacent screen will appear if In Process Cal is successful. The screen will return to the conductivity Cal Menu.

```
1.234 µS/cm  25.0 °C
SN InProcess Cal
Updated cell
constant:
1.00135/cm
```

The adjacent screen may appear if In Process Cal is unsuccessful. The screen will return to the conductivity Cal Menu.

```
1.234 µS/cm  25.0 °C
SN InProcess Cal
Calibration
Error

Press EXIT
```

9.4.4 Calibrating the Sensor To A Laboratory Instrument (meter cal)

This procedure is used to check and correct the conductivity reading of the 1066 using a laboratory conductivity instrument. This is done by submerging the conductivity probe in a bath and measuring the conductivity of a grab sample of the same bath water with a separate laboratory instrument. The 1066 reading is then adjusted to match the conductivity reading of the lab instrument.

The adjacent screen will appear after selecting Meter Cal from the Conductivity Calibration screen:

```
1.234 µS/cm  25.0 °C
SN Meter Cal
Use precision
resistors only
```

After pressing ENTER, the display shows the live value measured by the sensor

```
1.234 µS/cm  25.0 °C
SN Enter Value
xx.xx kΩ
```

If the meter cal is successful the screen will return to the conductivity Cal Menu.

```
1.234 µS/cm  25.0 °C
SN Meter Cal
Calibration
Error

Press EXIT
```

The adjacent screen will appear if Meter Cal is unsuccessful. The screen will return to the conductivity Cal Menu.

9.4.5 Cal Factor

Upon initial installation and power up, if 4-electrode was selected for the sensor type in the Quick Start menus, the user enters a Cell Constant and a "Cal Factor" using the instrument keypad. The cell constant is needed to convert measured conductance to conductivity as displayed on the transmitter screen. The "Cal Factor" entry is needed increase the accuracy of the live conductivity readings, especially at low conductivity readings below 20uS/cm. Both the Cell Constant and the "Cal Factor" are printed on the tag attached to the 4-electrode sensor/cable.

```
1.234 µS/cm  25.0 °C
SN Cal Factor
0.95000 /cm
```

9.5 Toroidal Conductivity Calibration

Calibration is the process of adjusting or standardizing the transmitter to a lab test or a calibrated laboratory instrument, or standardizing to some known reference (such as a conductivity standard). This section contains procedures for the first time use and for routine calibration of the 1066 transmitter.

To calibrate the conductivity loop with a connected contacting conductivity sensor, access the Calibration screen by pressing ENTER from the main screen and press ENTER.

The following calibration routines are covered:

1. Zero Cal Zero the transmitter with the sensor attached
2. In Process Cal Standardize the sensor to a known conductivity
3. Cell K: 1.00000/cm Enter the cell Constant for the sensor
4. Meter Cal Calibrate the transmitter to a lab conductivity instrument

To calibrate toroidal conductivity:

1. Press the MENU button
2. Select Calibrate. Press ENTER.
3. Select Conductivity. Press ENTER.

The adjacent screen will appear. To calibrate Toroidal Conductivity or Temperature, scroll to the desired item and press ENTER

The following sub-sections show the initial display screen that appears for each calibration routine. Use the flow diagram for Conductivity calibration at the end of [Section 7](#) and the live screen prompts to complete calibration.

The adjacent screen appears after selecting Conductivity calibration:

1.234 μ S/cm	25.0 °C
Calibration	
Zero Cal	
In Process Cal	
Cell K:	2.7000/cm

9.5.1 Entering the Cell Constant

New toroidal sensors always need to be calibrated. The cell constant provided on the sensor label is a nominal value and does not need to be entered.

This procedure sets up the transmitter for the probe type connected to the transmitter. Each type of probe has a specific cell constant

The display screen for entering a cell constant for the sensor is shown. The default value is displayed in bold type.

1.234 μ S/cm	25.0 °C
Cell Constant	
2.7000/cm	

9.5.2 Zeroing the Instrument

This procedure is used to compensate for small offsets to the conductivity signal that are present even when there is no conductivity to be measured. This procedure is affected by the length of extension cable and should always be repeated if any changes in extension cable or sensor have been made. Electrically connect the conductivity probe as it will actually be used and place the measuring portion of the probe in air.

The adjacent screen will appear after selecting Zero Cal from the Conductivity Calibration screen:

```
1.234 µS/cm  25.0 °C
           SN Zero Cal
In Air
In Water
```

The adjacent screen will appear if zero Cal is successful. The screen will return to the conductivity Cal Menu.

```
1.234 µS/cm  25.0 °C
           SN Zero Cal
Sensor Zero Done
```

The adjacent screen may appear if zero Cal is unsuccessful.

```
1.234 µS/cm  25.0 °C
           SN Zero Cal
Sensor Zero Fail
Offset too high

Press EXIT
```

9.5.3 Calibrating the Sensor in a Conductivity Standard (in process cal)

This procedure is used to check and correct the conductivity reading of the 1066 to ensure that the reading is accurate. This is done by submerging the probe in the sample of known conductivity, then adjusting the displayed value, if necessary, to correspond to the conductivity value of the sample. The probe must be cleaned before performing this procedure. The temperature reading must also be checked and standardized if necessary, prior to performing this procedure.

The adjacent screen will appear after selecting In Process Cal from the Conductivity Calibration screen:

```
1.234 µS/cm  25.0 °C
           SN InProcess Cal
Wait for stable
reading.
```

The following screen will appear if In Process Cal is successful. The screen will return to the conductivity Cal Menu.

```
1.234 µS/cm  25.0 °C
           SN InProcess Cal
Updated cell
constant:
3.01350/cm
```

This screen may appear if In Process Cal is unsuccessful. The screen will return to the conductivity Cal Menu.

```
1.234 µS/cm  25.0 °C
           SN InProcess Cal
Calibration
Error

Press EXIT
```

9.6 Calibration – Chlorine

The 1066 can measure three variants of Chlorine:

- Free Chlorine
- Total Chlorine
- Monochloramine

The section describes how to calibrate any compatible amperometric chlorine sensor. The following calibration routines are covered in the family of supported Chlorine sensors:

- Air Cal
- Zero Cal
- In Process Cal

9.6.1 Calibration – Free Chlorine

A free chlorine sensor generates a current directly proportional to the concentration of free chlorine in the sample. Calibrating the sensor requires exposing it to a solution containing no chlorine (zero standard) and to a solution containing a known amount of chlorine (full-scale standard). The zero calibration is necessary because chlorine sensors, even when no chlorine is in the sample, generate a small current called the residual current. The transmitter compensates for the residual current by subtracting it from the measured current before converting the result to a chlorine value. New sensors require zeroing before being placed in service, and sensors should be zeroed whenever the electrolyte solution is replaced.

To calibrate the chlorine sensor, access the Calibration screen by pressing ENTER from the main screen and press ENTER.

The following calibration routines are covered:

1. Zero Cal Zeroing the sensor in solution with zero free chlorine
2. Grab Cal Standardizing to a sample of known free chlorine concentration

To calibrate free chlorine:

1. Press the MENU button
2. Select Calibrate. Press ENTER.
3. Select Free Chlorine. Press ENTER.

The adjacent screen will appear. To calibrate Free Chlorine or Temperature, scroll to the desired item and press ENTER.

1.234 $\mu\text{S}/\text{cm}$	25.0 $^{\circ}\text{C}$
SN Calibrate?	
Free Chlorine	
Temperature	

The following sub-sections show the initial display screen that appears for each calibration routine. Use the flow diagram for Chlorine calibration at the end of [Section 7](#) and the live screen prompts to complete calibration.

The adjacent screen appears after selecting Free Chlorine calibration:

1.234 $\mu\text{S}/\text{cm}$	25.0 $^{\circ}\text{C}$
SN Calibration	
Zero Cal	
In Process Cal	

9.6.1.1 Zeroing the Sensor

The adjacent screen will appear during Zero Cal. Be sure sensor has been running in zero solution for at least two hours before starting zero step.

```
1.234 µS/cm  25.0 °C
SN Zero Cal
Zeroing
Wait
```

The adjacent screen will appear if In Zero Cal is successful. The screen will return to the Amperometric Cal Menu.

```
1.234 µS/cm  25.0 °C
SN Zero Cal
Sensor zero done
```

The adjacent screen may appear if In Zero Cal is unsuccessful. The screen will return to the Amperometric Cal Menu.

```
1.234 µS/cm  25.0 °C
SN Zero Cal
Sensor zero failed

Press EXIT
```

9.6.1.2 In Process Calibration

The adjacent screen will appear prior to In Process Cal

```
1.234 µS/cm  25.0 °C
SN InProcess Cal
Wait for stable
reading.
```

If the In Process Cal is successful, the screen will return to the Cal sub-menu.

The adjacent screen may appear if In Zero Cal is unsuccessful. The screen will return to the Amperometric Cal Menu.

```
1.234 µS/cm  25.0 °C
SN InProcess Cal
Calibration
Error

Press EXIT
```

9.6.2 Calibration – Total Chlorine

Total chlorine is the sum of free and combined chlorine. The continuous determination of total chlorine requires two steps. First, the sample flows into a conditioning system (TCL) where a pump continuously adds acetic acid and potassium iodide to the sample. The acid lowers the pH, which allows total chlorine in the sample to quantitatively oxidize the iodide in the reagent to iodine. In the second step, the treated sample flows to the sensor. The sensor is a membrane-covered amperometric sensor, whose output is proportional to the concentration of iodine. Because the concentration of iodine is proportional to the concentration of total chlorine, the transmitter can be calibrated to read total chlorine. Because the sensor really measures iodine, calibrating the sensor requires exposing it to a solution containing no iodine (zero standard) and to a solution containing a known amount of iodine (full-scale standard). The Zero calibration is necessary because the sensor, even when no iodine is present, generates a small current called the residual current. The transmitter compensates for the residual current by subtracting it from the measured current before converting the result to a total chlorine value. New sensors require zeroing before being placed in service, and sensors should be zeroed whenever the electrolyte solution is replaced. The best zero standard is deionized water. The purpose of the In Process Calibration is to

establish the slope of the calibration curve. Because stable total chlorine standards do not exist, the sensor must be calibrated against a test run on a grab sample of the process liquid. Several manufacturers offer portable test kits for this purpose.

To calibrate the chlorine sensor, access the Calibration screen by pressing ENTER from the main screen, and press ENTER.

The following calibration routines are covered:

1. Zero Cal Zeroing the sensor in solution with zero total chlorine
2. Grab Cal Standardizing to a sample of known total chlorine concentration

To calibrate total chlorine:

1. Press the MENU button
2. Select Calibrate. Press ENTER.
3. Select Total Chlorine. Press ENTER.

The adjacent screen will appear. To calibrate Total Chlorine or Temperature, scroll to the desired item and press ENTER

```
1.234 µS/cm  25.0 °C
SN Calibrate?
Total Chlorine
Temperature
```

The following sub-sections provide you with the initial display screen that appears for each calibration routine. Use the flow diagram for Chlorine calibration at the end of Sec. 9 and the live screen prompts to complete calibration.

This adjacent screen appears after selecting Total Chlorine calibration:

```
1.234 µS/cm  25.0 °C
SN Calibration
Zero Cal
In Process Cal
```

9.6.2.1 Zeroing the Sensor

The adjacent screen will appear during Zero Cal. Be sure sensor has been running in zero solution for at least two hours before starting zero step.

```
1.234 µS/cm  25.0 °C
SN Zero Cal
Zeroing
Wait
```

The adjacent screen will appear if In Zero Cal is successful. The screen will return to the Amperometric Cal Menu.

```
1.234µS/cm  25.0°C
SN Zero Cal
Sensor zero done
```

The adjacent screen may appear if In Zero Cal is unsuccessful. The screen will return to the Amperometric Cal Menu.

```
1.234 µS/cm  25.0 °C
SN Zero Cal
Sensor zero failed

Press EXIT
```

9.6.2.2 In Process Calibration

The adjacent screen will appear prior to In Process Cal

If the In Process Cal is successful, the screen will return to the Cal sub-menu.

```
1.234 µS/cm  25.0 °C
SN InProcess Cal
Wait for stable
reading.
```

The adjacent screen may appear if In Process Cal is unsuccessful. The screen will return to the Amperometric Cal Menu.

```
1.234 µS/cm  25.0 °C
SN InProcess Cal
Calibration error

Press EXIT
```

9.6.3 Calibration – Monochloramine

A monochloramine sensor generates a current directly proportional to the concentration of monochloramine in the sample. Calibrating the sensor requires exposing it to a solution containing no monochloramine (zero standard) and to a solution containing a known amount of monochloramine (full-scale standard). The zero calibration is necessary because monochloramine sensors, even when no monochloramine is in the sample, generate a small current called the residual or zero current. The transmitter compensates for the residual current by subtracting it from the measured current before converting the result to a monochloramine value. New sensors require zeroing before being placed in service, and sensors should be zeroed whenever the electrolyte solution is replaced. The best zero standard is deionized water. The purpose of the In Process calibration is to establish the slope of the calibration curve. Because stable monochloramine standards do not exist, the sensor must be calibrated against a test run on a grab sample of the process liquid. Several manufacturers offer portable test kits for this purpose.

To calibrate the chlorine sensor, access the Calibration screen by pressing ENTER from the main screen, and press ENTER.

The following calibration routines are covered:

1. Zero Cal Zeroing the sensor in solution with zero total chlorine
2. Grab Cal Standardizing to a sample of known monochloramine concentration

To calibrate monochloramine:

1. Press the MENU button
2. Select Calibrate. Press ENTER.
3. Select Monochloramine. Press ENTER.

The adjacent screen will appear. To calibrate Monochloramine or Temperature, scroll to the desired item and press ENTER.

1.234 $\mu\text{S/cm}$ 25.0 $^{\circ}\text{C}$ SN Calibrate? Monochloramine Temperature
--

The following sub-sections provide you with the initial display screen that appears for each calibration routine. Use the flow diagram for Chlorine calibration at the end of Sec. 9 and the live screen prompts to complete calibration.

The adjacent screen appears after selecting Monochloramine calibration:

1.234 $\mu\text{S/cm}$ 25.0 $^{\circ}\text{C}$ SN Calibration Zero Cal In Process Cal
--

9.6.4 Zeroing the Sensor

The adjacent screen will appear during Zero Cal. Be sure sensor has been running in zero solution for at least two hours before starting zero step.

1.234 $\mu\text{S/cm}$	25.0 $^{\circ}\text{C}$
SN Zero Cal	
Zeroing	
Wait	

The adjacent screen will appear if In Zero Cal is successful. The screen will return to the Amperometric Cal Menu.

1.234 $\mu\text{S/cm}$	25.0 $^{\circ}\text{C}$
SN Zero Cal	
Sensor zero done	

The adjacent screen may appear if In Zero Cal is unsuccessful. The screen will return to the Amperometric Cal Menu.

1.234 $\mu\text{S/cm}$	25.0 $^{\circ}\text{C}$
SN Zero Cal	
Sensor zero failed	
Press EXIT	

9.6.5 In Process Calibration

The adjacent screen will appear prior to In Process Cal

If the In Process Cal is successful, the screen will return to the Cal sub-menu.

1.234 $\mu\text{S/cm}$	25.0 $^{\circ}\text{C}$
SN InProcess Cal	
Wait for stable reading.	

The adjacent screen may appear if In Process Cal is unsuccessful. The screen will return to the Amperometric Cal Menu.

1.234 $\mu\text{S/cm}$	25.0 $^{\circ}\text{C}$
SN InProcess Cal	
Calibration Error	
Press EXIT	

9.7 Calibration – Oxygen

Oxygen sensors generate a current directly proportional to the concentration of dissolved oxygen in the sample. Calibrating the sensor requires exposing it to a solution containing no oxygen (zero standard) and to a solution containing a known amount of oxygen (full-scale standard). The Zero Calibration is necessary because oxygen sensors, even when no oxygen is present in the sample, generate a small current called the residual current. The transmitter compensates for the residual current by subtracting it from the measured current before converting the result to a dissolved oxygen value. New sensors require zeroing before being placed in service, and sensors should be zeroed whenever the electrolyte solution is replaced. The recommended zero standard is 5% sodium sulfite in water, although oxygen-free nitrogen can also be used. The 499A TrDO sensor, used for the determination of trace (ppb) oxygen levels, has very low residual current and does not normally require zeroing. The residual current in the 499A TrDO sensor is equivalent to less than 0.5 ppb oxygen. The purpose of the In Process Calibration is to establish the slope of the calibration curve. Because the solubility of atmospheric oxygen in water as a function of temperature and barometric pressure is well known, the natural choice for a full-scale standard is air-saturated water. However, air-saturated water is difficult to prepare and use, so the universal practice is to use air for calibration. From the point of view of the oxygen sensor, air and air-

saturated water are identical. The equivalence comes about because the sensor really measures the chemical potential of oxygen. Chemical potential is the force that causes oxygen molecules to diffuse from the sample into the sensor where they can be measured. It is also the force that causes oxygen molecules in air to dissolve in water and to continue to dissolve until the water is saturated with oxygen. Once the water is saturated, the chemical potential of oxygen in the two phases (air and water) is the same. Oxygen sensors generate a current directly proportional to the rate at which oxygen molecules diffuse through a membrane stretched over the end of the sensor. The diffusion rate depends on the difference in chemical potential between oxygen in the sensor and oxygen in the sample. An electrochemical reaction, which destroys any oxygen molecules entering the sensor, keeps the concentration (and the chemical potential) of oxygen inside the sensor equal to zero. Therefore, the chemical potential of oxygen in the sample alone determines the diffusion rate and the sensor current. When the sensor is calibrated, the chemical potential of oxygen in the standard determines the sensor current. Whether the sensor is calibrated in air or air-saturated water is immaterial. The chemical potential of oxygen is the same in either phase. Normally, to make the calculation of solubility in common units (like ppm DO) simpler, it is convenient to use water-saturated air for calibration. Automatic air calibration is standard. The user simply exposes the sensor to water-saturated air. The transmitter monitors the sensor current. When the current is stable, the transmitter stores the current and measures the temperature using a temperature element inside the oxygen sensor. The user must enter the barometric pressure. From the temperature the transmitter calculates the saturation vapor pressure of water. Next, it calculates the pressure of dry air by subtracting the vapor pressure from the barometric pressure. Using the fact that dry air always contains 20.95% oxygen, the transmitter calculates the partial pressure of oxygen. Once the transmitter knows the partial pressure of oxygen, it uses the Bunsen coefficient to calculate the equilibrium solubility of atmospheric oxygen in water at the prevailing temperature. At 25 °C and 760 mm Hg, the equilibrium solubility is 8.24 ppm. Often it is too difficult or messy to remove the sensor from the process liquid for calibration. In this case, the sensor can be calibrated against a measurement made with a portable laboratory instrument. The laboratory instrument typically uses a membrane-covered amperometric sensor that has been calibrated against water-saturated air.

To calibrate the oxygen sensor, access the Calibration screen by pressing ENTER from the main screen, select and press ENTER.

The following calibration routines are covered:

1. Zero Cal Zeroing the sensor in a medium with zero oxygen
2. Air Cal Calibrating the sensor in a water-saturated air sample
3. In Process Cal Standardizing to a sample of known oxygen concentration
4. Sen@ 25 °C:2500 nA/ppm Entering a known slope value for sensor response

To calibrate oxygen:

1. Press the MENU button
2. Select Calibrate. Press ENTER.
3. Select Oxygen. Press ENTER.

The adjacent screen will appear. To calibrate Oxygen or Temperature, scroll to the desired item and press ENTER

1.234 μ S/cm 25.0 °C SN Calibrate? Oxygen Temperature
--

The following sub-sections provide you with the initial display screen that appears for each calibration routine. Use the flow diagram for Oxygen calibration at the end of [Section 9](#) and the live screen prompts for each routine to complete calibration.

The adjacent screen appears after selecting Oxygen calibration:

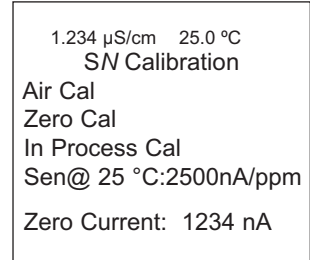

Air calibration criteria can be changed.

The following criteria can be adjusted:

- Stabilization time (default 10 sec.)
- Stabilization pH value (default 0.05 ppm)
- Salinity of the solution to be measured (default 00.0 parts per thousand)

The adjacent screen will appear to allow adjustment of these criteria:

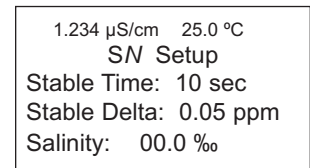

9.7.1 Zeroing the Sensor

The adjacent screen will appear during Zero Cal.

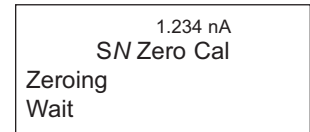

The adjacent screen will appear if In Zero Cal is successful. The screen will return to the Amperometric Cal Menu.

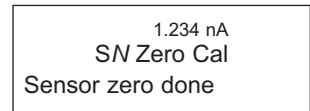

The adjacent screen may appear if In Zero Cal is unsuccessful. The screen will return to the Amperometric Cal Menu.

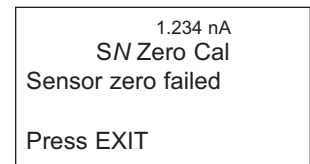

9.7.2 Calibrating the Sensor in Air

The adjacent screen will appear prior to Air Cal

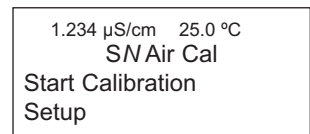

The adjacent screen will appear if In Air Cal is successful. The screen will return to the Amperometric Cal Menu.

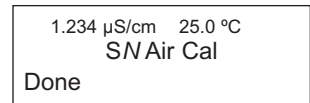

The adjacent screen may appear if In Air Cal is unsuccessful. The screen will return to the Amperometric Cal Menu.



9.7.3 Calibrating the Sensor Against A Standard Instrument (in process cal)

The adjacent screen will appear prior to In Process Cal

If the In Process Cal is successful, the screen will return to the Cal sub-menu.

The adjacent screen may appear if In Zero Cal is unsuccessful. The screen will return to the Amperometric Cal Menu.

9.8 Calibration – Ozone

An ozone sensor generates a current directly proportional to the concentration of ozone in the sample. Calibrating the sensor requires exposing it to a solution containing no ozone (zero standard) and to a solution containing a known amount of ozone (full-scale standard). The Zero Calibration is necessary because ozone sensors, even when no ozone is in the sample, generate a small current called the residual or zero current. The transmitter compensates for the residual current by subtracting it from the measured current before converting the result to an ozone value. New sensors require zeroing before being placed in service, and sensors should be zeroed whenever the electrolyte solution is replaced. The best zero standard is deionized water. The purpose of the In Process Calibration is to establish the slope of the calibration curve. Because stable ozone standards do not exist, the sensor must be calibrated against a test run on a grab sample of the process liquid. Several manufacturers offer portable test kits for this purpose.

To calibrate the ozone sensor, access the Calibration screen by pressing ENTER from the main screen, select and press ENTER.

The following calibration routines are covered:

1. Zero Cal Zeroing the sensor in solution with zero total chlorine
2. Grab Cal Standardizing to a sample of known ozone concentration

To calibrate ozone:

1. Press the MENU button
2. Select Calibrate. Press ENTER.
3. Select Ozone. Press ENTER.

The adjacent screen will appear. To calibrate Ozone or Temperature, scroll to the desired item and press ENTER.

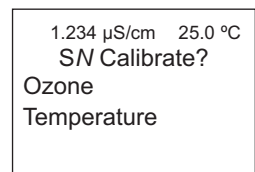

The following sub-sections provide you with the initial display screen that appears for each calibration routine. Use the flow diagram for Ozone calibration at the end of [Section 9](#) and the live screen prompts to complete calibration.

The adjacent screen appears after selecting Ozone calibration:

```

1.234 µS/cm  25.0 °C
SN Calibration
Zero Cal
In Process Cal
  
```

9.8.1 Zeroing the Sensor

The following screen will appear during Zero Cal

```

1.234 nA
SN Zero Cal
Zeroing
Wait
  
```

The following screen will appear if In Zero Cal is successful. The screen will return to the Amperometric Cal Menu.

```

1.234 nA
SN Zero Cal
Sensor zero done
  
```

The following screen may appear if In Zero Cal is unsuccessful. The screen will return to the Amperometric Cal Menu.

```

1.234 nA
SN Zero Cal
Sensor zero failed
Press EXIT
  
```

9.8.2 In Process Calibration

The following screen will appear after selecting In Process Cal

```

1.234 µS/cm  25.0 °C
SN InProcess Cal
Wait for stable
reading.
  
```

If the In Process Cal is successful, the screen will return to the Cal sub-menu. The following screen may appear if In Zero Cal is unsuccessful. The screen will return to the Amperometric Cal Menu.

```

1.234 µS/cm  25.0 °C
SN InProcess Cal
Calibration
Error
Press EXIT
  
```

9.9 Calibrating Temperature

Most liquid analytical measurements require temperature compensation (except ORP and Redox). The 1066 performs temperature compensation automatically by applying internal temperature correction algorithms. Temperature correction can also be turned off. If temperature correction is off, the 1066 uses the manual temperature entered by the user in all temperature correction calculations.

To calibrate temperature, access the Calibration screen by pressing ENTER from the main screen, select Temperature and press ENTER.

The following calibration routine is covered:

1. Temperature with manual temperature entry

To calibrate temperature:

1. Press the MENU button
2. Select Calibrate. Press ENTER.
3. Select Temperature. Press ENTER.

The adjacent screen will appear.

1.234 $\mu\text{S/cm}$ 25.0 $^{\circ}\text{C}$ SN Calibrate +0 25.0 $^{\circ}\text{C}$
--

The following sub-section provides you with the initial display screen that appears for temperature calibration. Use the **flow diagram for Temp calibration** at the end of Sec. 7 to complete calibration.

9.9.1 Calibration

The adjacent screen will appear during Temperature Cal.

If the sensor Temperature offset is greater than 5 $^{\circ}\text{C}$ from the default value, the following screen will appear:

1.234 $\mu\text{S/cm}$ 25.0 $^{\circ}\text{C}$ SN Calibrate Cal in progress. Please wait.
--

You may continue by selecting Yes or suspend this operation by selecting No.

1.234 $\mu\text{S/cm}$ 25.0 $^{\circ}\text{C}$ SN Temp Offset > 5 $^{\circ}\text{C}$ Continue? No Yes
--

If the Temp Cal is successful, the screen will return to the Cal Menu.

Note: To select automatic or manual temp compensation or to program temperature units as $^{\circ}\text{C}$ or $^{\circ}\text{F}$, refer to [Section 7.3](#) – Programming Temperature in this manual.

FIGURE 9-1. Calibrate pH

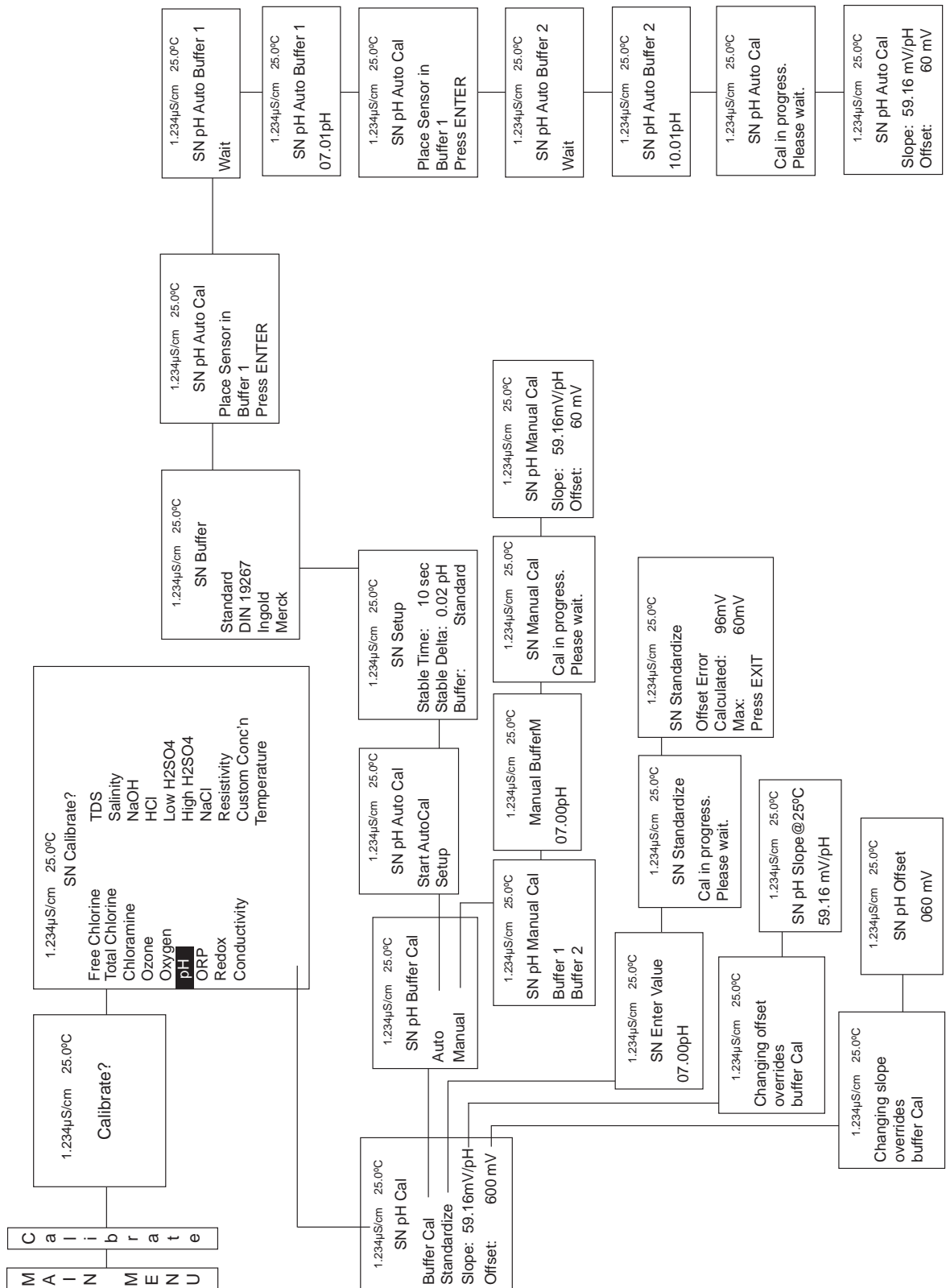

Figure 9-2. Calibrate Contacting and Toroidal Conductivity

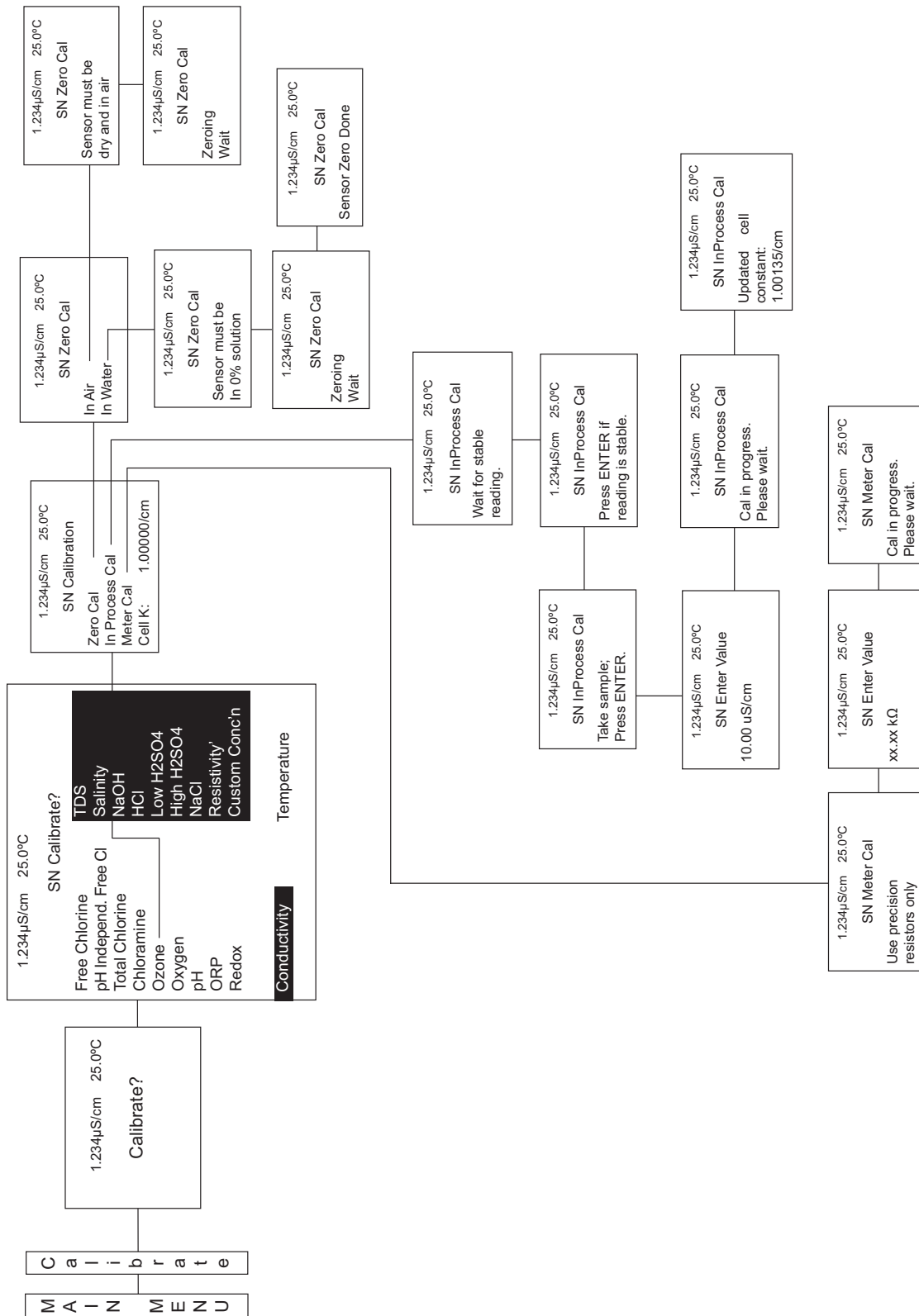

Figure 9-3. Calibrate Free Chlorine, Total Chlorine, and Monochloramine

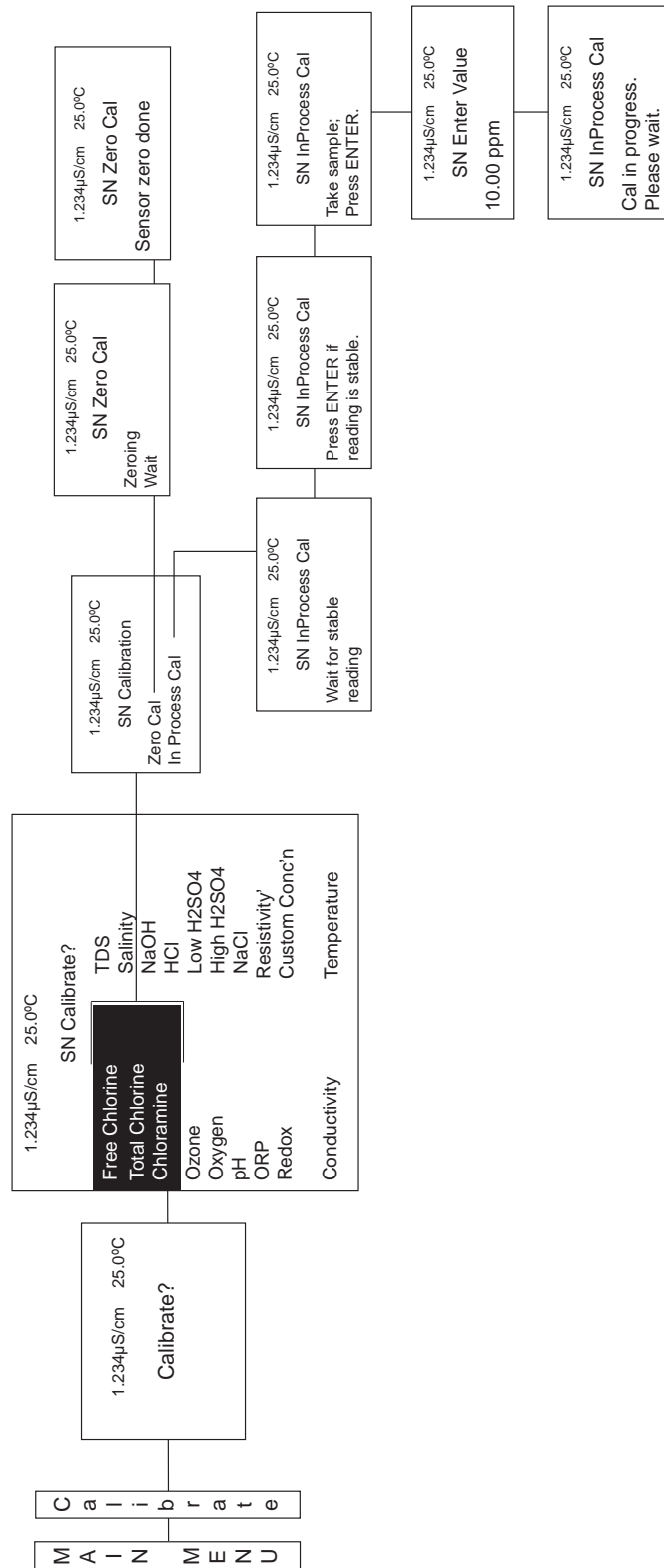

Figure 9-4. Calibrate Oxygen

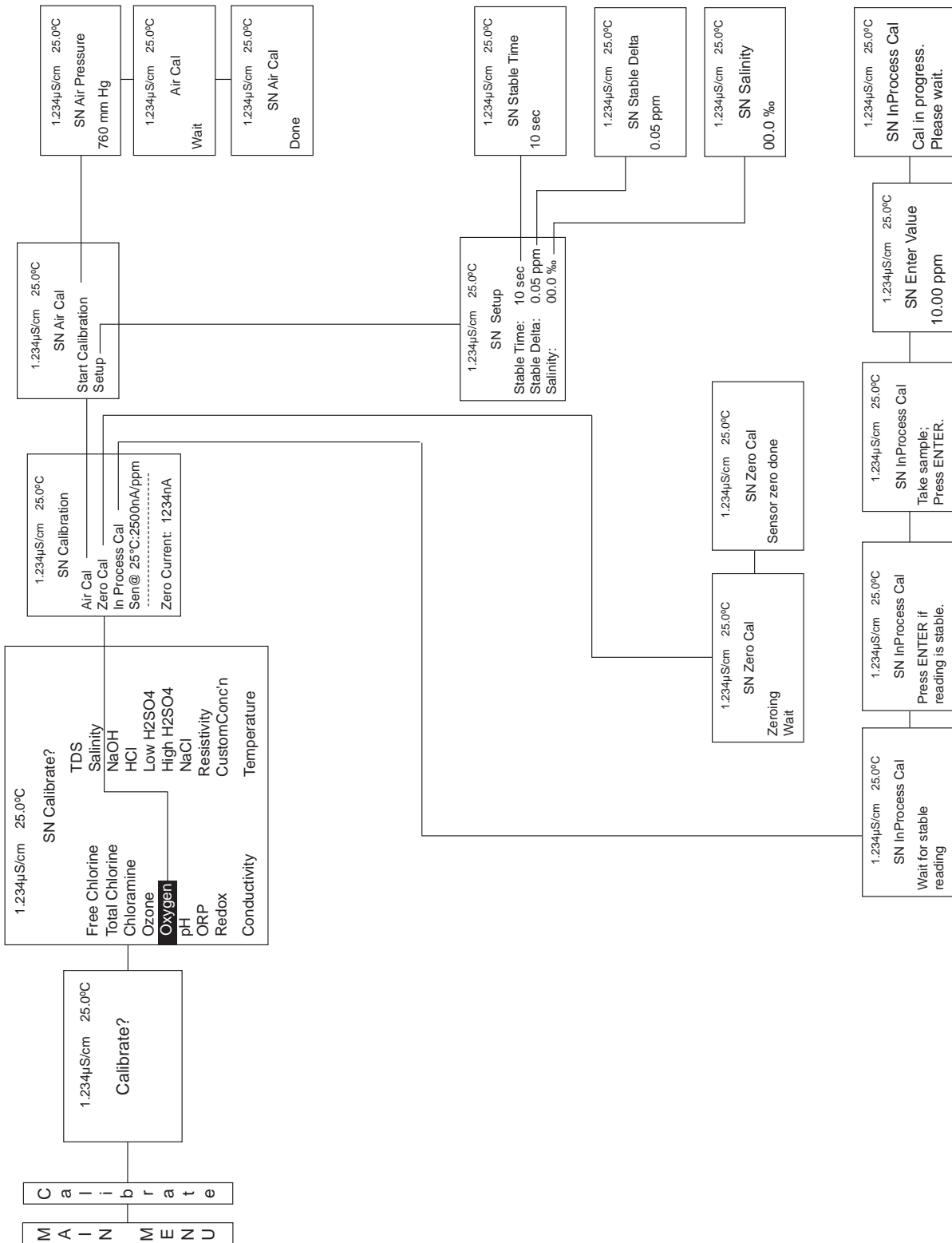

Figure 9-5. Calibrate Ozone

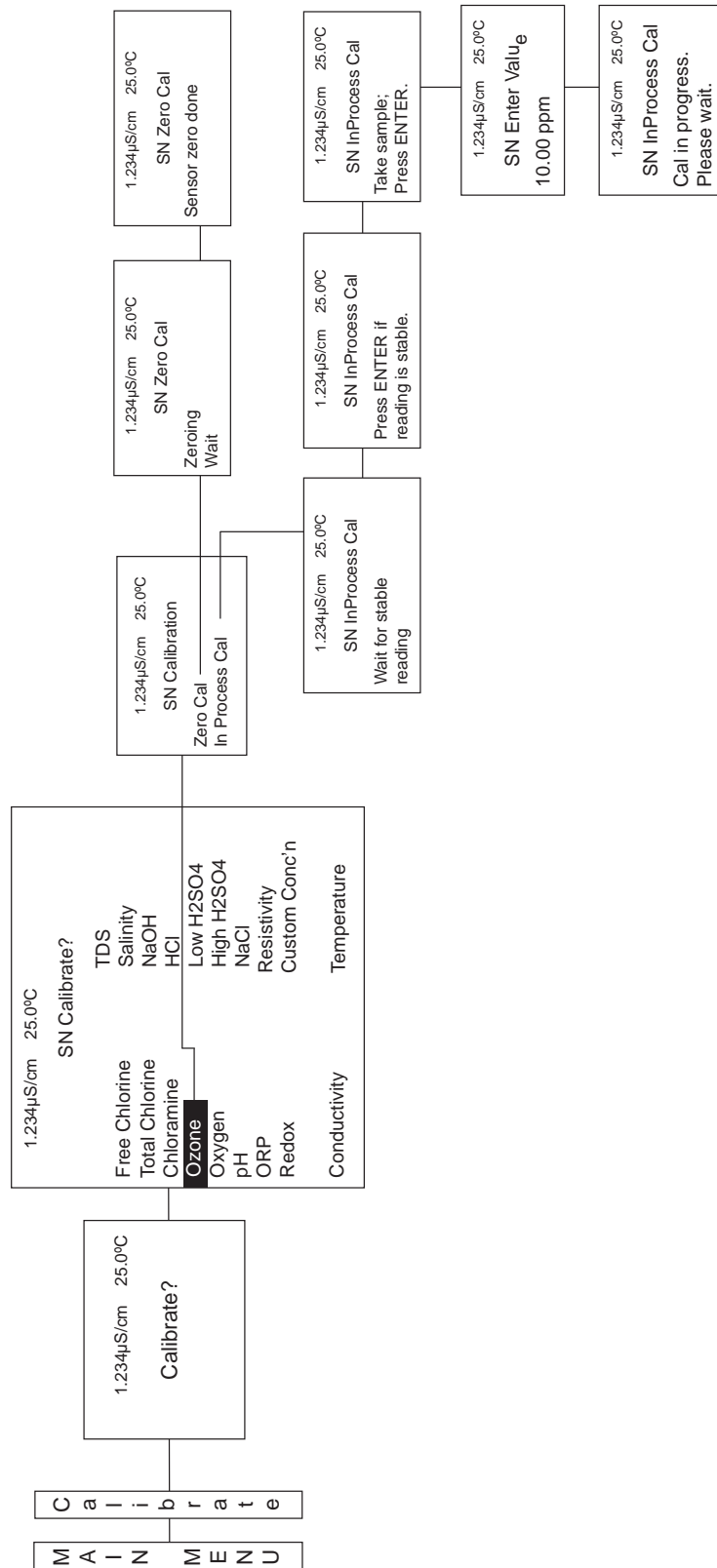

FIGURE 9-6. Calibrate ORP

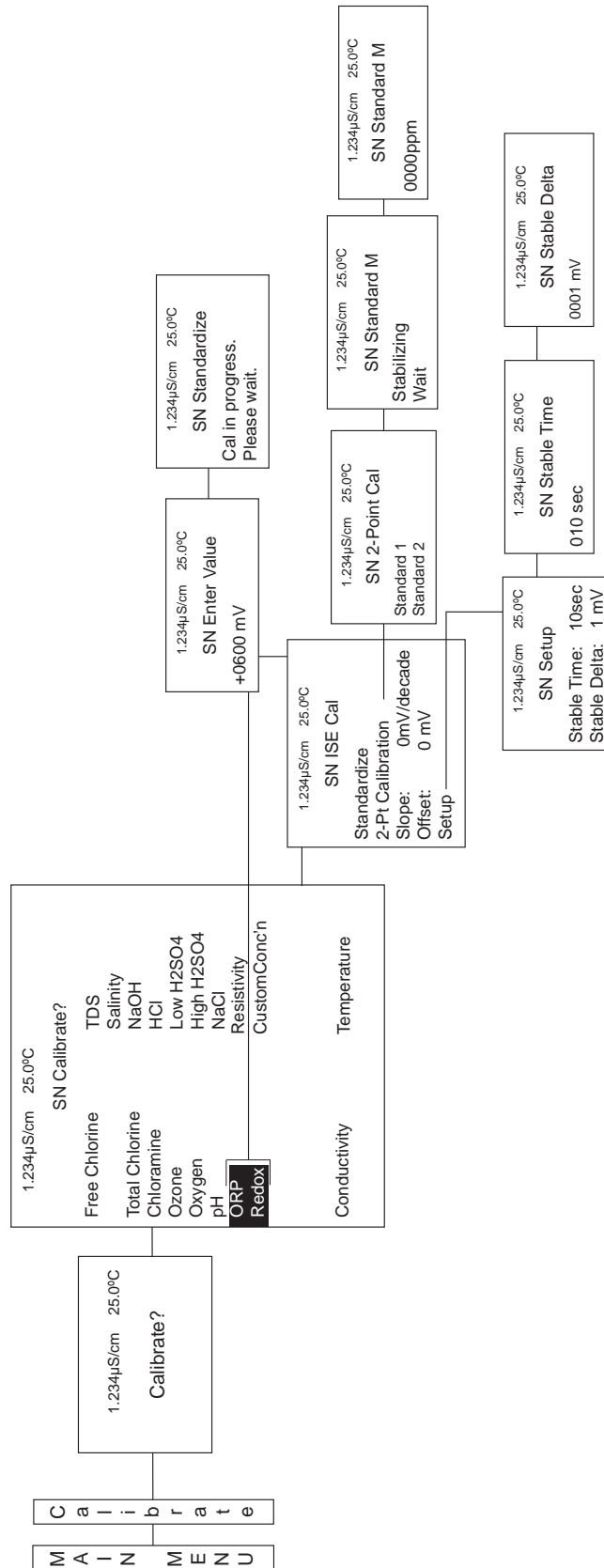
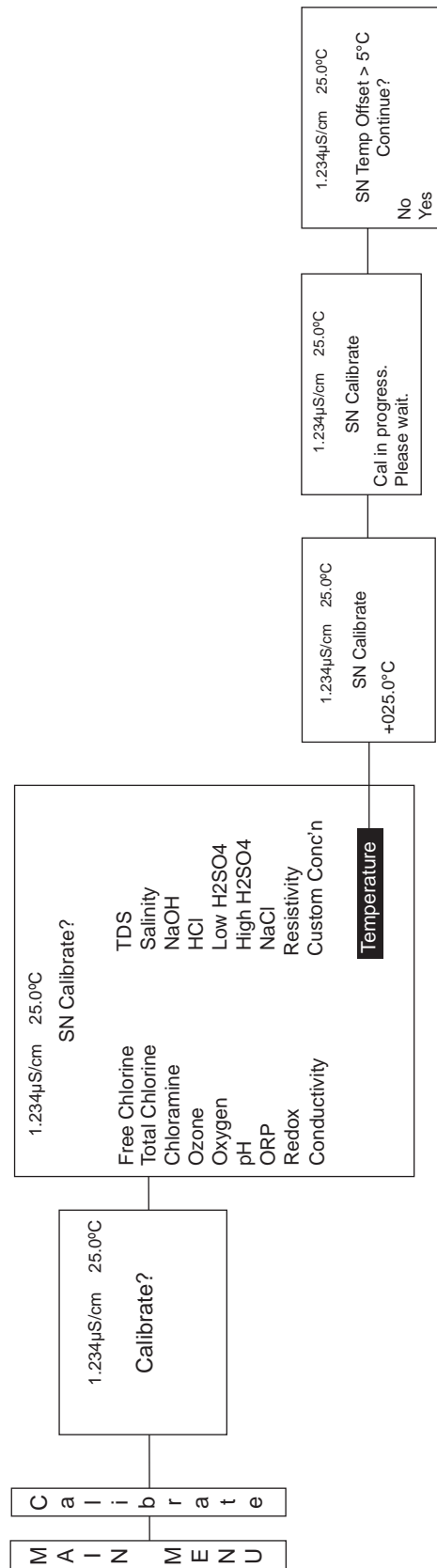

FIGURE 9-7. Calibrate Temperature



Section 10: HART® Communications

10.1 Introduction

The 1066 transmitter can communicate with a HART host using HART Revision 5 or HART Revision 7. The revision of HART used by the 1066 can be selected using the keypad/display or a HART master such as AMS or the 475 Handheld Communicator. The default version of HART is Revision 5. Since some HART hosts cannot accommodate HART 7, the choice of HART Revision should be based on the capabilities of the host, and should be chosen as a first step in configuration. If HART Revision 7 can be used with the host, it does offer a number of advantages over Revision 5, including long tag name, time stamped data, and measurement status, and enhanced burst mode.

When **HART 5** is chosen, the Device Revision of the 1066 is Device Revision 1; when **HART 7** is chosen the Device Revision is **Revision 2** (or greater). The Device Revision of the DD (Device Description) and install files for AMS and DeltaV used should be the same as the Device Revision of the 1066.

A single HART 5 (Device Revision 1) or HART 7 (Device Revision 2 or greater) DD (Device Description) is used for all model codes of the 1066, which include the pH/ORP, conductivity, oxygen, chlorine, and ozone transmitters. All 1066 transmitters have the same HART device identification, as outlined below:

HART 5 Device Identification (1066 Revision 1):

Manufacturer Name: Rosemount

Model Name: 1066

Manufacturer ID: 46 (0x2E)

Device Type Code: 33 (0x0021)

HART Protocol Revision: 5.1

Device Revision: 1

HART 7 Device Identification (1066 Revision 2):

Manufacturer Name: Rosemount

Model Name: 1066

Manufacturer ID: 46 (0x2E)

Device Type Code: 11809 (0x2E21)

HART Protocol Revision: 7.3

Device Revision: 2

10.2 Physical Installation and Configuration

10.2.1 HART Wiring and Output Configuration

HART communications is superimposed on Analog Output 1 for all of the measurements and parameters of the 1066.

10.2.2 HART Multidrop (Bus) Configuration

The HART Polling Address should be left at its default value of “0”, unless the 1066 is used in a Multidrop configuration with up to 14 other transmitters. When the Polling Address is greater than “0”, the 4-20 mA output is held at 4 mA or below, and does not change in response to changes in the measurement in HART 5.

In HART 7, Loop Current Mode should be set to “Off” to hold the current output to a minimum value.

10.2.3 HART Configuration

To access the HART Configuration screens, select the “HART” menu item in the Main Menu. If HART 7 is chosen (Univ Cmd Rev = 7), the following controls are available:

FIGURE 10-1. HART 7 Configuration Screen: Basic Definitions

Univ Cmd Rev:	7
Polling Address:	0
Loop Current Mode:	Off
Find Device Cmd:	Off
Burst Message 0:	Off
Burst Message 1:	Off
Burst Message 2:	Off

- **Univ Cmd Rev** – toggles between HART version 5 and HART version 7. If the HART host being used can accommodate HART 7, HART 7 should be chosen due to its larger feature set. If the host can only use HART 5, then HART 5 must be chosen.
Note: If the 1066 is connected to a HART host and the HART version is changed, the host will likely detect the transmitter as a new transmitter with a different device revision number.
- **Polling address** – Choose “0” unless Multidrop is being used. If Multidrop is being used, each transmitter should have its own polling address of from 1 to 15.
- **Loop current mode** – Set Output 1 current to a minimum value for multidrop applications (HART 7 only).
- **Find Device Cmd** – Setting Find Device to “On”, enables the 1066 to be identified by the host. The transmitter returns identity information including device type, revision level, and device ID (HART 7 only).

- **Burst Message 0, 1, 2** – Toggles burst messages 0, 1, and/or 2 on or off (HART 7 only). See the end of [section 10.2](#) for the HART burst commands available.

If HART 5 is chosen (Univ Cmd Rev = 5), the following controls are available:

FIGURE 10-2. HART 5 Configuration Screen: Basic Definitions

Univ Cmd Rev:	5
Polling Address:	0
Burst Mode:	Off

- **Univ Cmd Rev** – toggles between HART version 5 and HART version 7. If the HART host being used can accommodate HART 7, HART 7 should be chosen due to its larger feature set. If the host can only use HART 5, then HART 5 must be chosen.
Note: If the 1066 is connected to a HART host and the HART version is changed, the host will likely detect the transmitter as a new transmitter with a different device revision number.
- **Polling address** – Choose “0” unless Multidrop is being used. If Multidrop is being used, each transmitter should have its own polling address of from 1 to 15.
- **Burst Mode** – Toggles the single HART 5 burst message on or off. See below for the HART burst commands available.

Burst Commands Available in HART 5 and HART 7

If burst messages are enabled by setting the burst messages to on, the information in the burst message can be selected using a HART host from the following commands:

- **Burst command:**
 - Off** – Turns burst mode off
 - Cmd 1** – Bursts the Primary Value
 - Cmd 2** – Bursts Loop Current + % of range of the Primary Value
 - Cmd 3** – Bursts Dynamic Variables (PV, SV, TV, & QV) + Loop Current
 - Cmd 9** – Bursts up to 8 Device Variables with time stamp and status and Cmd 48 Additional Transmitter Status (HART 7 only)
 - Cmd 33** – Bursts 4 Device Variables
 - Cmd 48** – Bursts Additional Transmitter Status Bits (HART 7 only)
 - Cmd 93** – Bursts Trend Data (HART 7 only)

10.3 Measurements Available via HART

A number of live measurements are made available by HART in addition to the main measurements such as pH or Conductivity. All of these measurements are called Device Variables, which can be mapped to the Dynamic Variables PV, SV, TV, and QV for regular reading by the typical HART host.

Each 1066 transmitter type, 1066P, 1066C, etc. will have its own set of Device Variables, based on the secondary measurements used in making the main measurement. **Appendix 10.1** shows the Device Variable for the each transmitter type, and the Dynamic Variables, which they can be mapped to.

10.4 Diagnostics Available via HART

10.4.1 Status Information – Device Status Bits

Bit 0 Primary Variable out of Limits:

This bit is set when PV is out of its limits.

Bit 1 Non-primary Variable out of Limits:

This bit is set when any active device variable other than the Primary variable is out of its limits.

Bit 2 Loop Current Saturated:

This bit is set when Analog Output 1 is not fixed, and it is less than 3.8 mA or greater than 22.0 mA.

Bit 3 Loop Current Fixed:

This bit is set when Analog Output 1 is being simulated, calibrated, or when a device failure is detected and the Analog Output 1 is configured to output a fixed value.

Bit 4 More Status Available:

The “more status available” bit will be set when the device status condition occurs (i.e. bit goes from 0 to 1) on at least one of the Additional Transmitter Status bits are set.

Bit 5 Cold Start:

This bit is set when a Master Reset is performed either by Command 42, or a power cycle. 2 bits are maintained internally, for primary and secondary masters.

Bit 6 Configuration Changed:

This bit is set when a configuration or calibration parameter is changed either through a write command or a local interface command. 2 bits are maintained internally, for primary and secondary masters.

Bit 7 Field Device Malfunction:

This bit is set when a fault condition is detected in the device electronics or sensor.

10.4.2 Status Information – Extended Device Status Bits (HART 7 only)

Bit 0 Maintenance Required:

This bit is set when a device fault is detected.

Bit 1 Device Variable Alert:

This bit is set when any enabled device variable status is not good.

Bit 2 Critical Power Failures:

This bit is not supported and will always be cleared on 1066.

10.4.2 Additional Transmitter Status (Command 48)

Additional Transmitter Status provides diagnostic status bits specific to the condition of sensors, electronics, and the memory of the 1066. Calibration errors and notification of events, such as calibration in progress and relay activation are also indicated by status bits. **Appendix 10.2** shows these bits organized according to the 1066 transmitter measurement type.

10.5 HART Hosts

A HART host can access live measurements, diagnostic messages, and provide a tool for configuring the measurement and calibrating the 1066. The configuration parameters for the 1066 transmitter are listed in **Appendix 10.3**. Two examples of HART hosts are shown below.

10.5.1 AMS Intelligent Device Manager

The AMS Device Intelligent Device Manager is member of the AMS Suite of asset management applications, which provides tools for configuration, calibration, diagnosing, and documenting transmitters and valves. The following AMS windows are examples of these functions:

FIGURE 10-3. Main Measurement and Overall Status

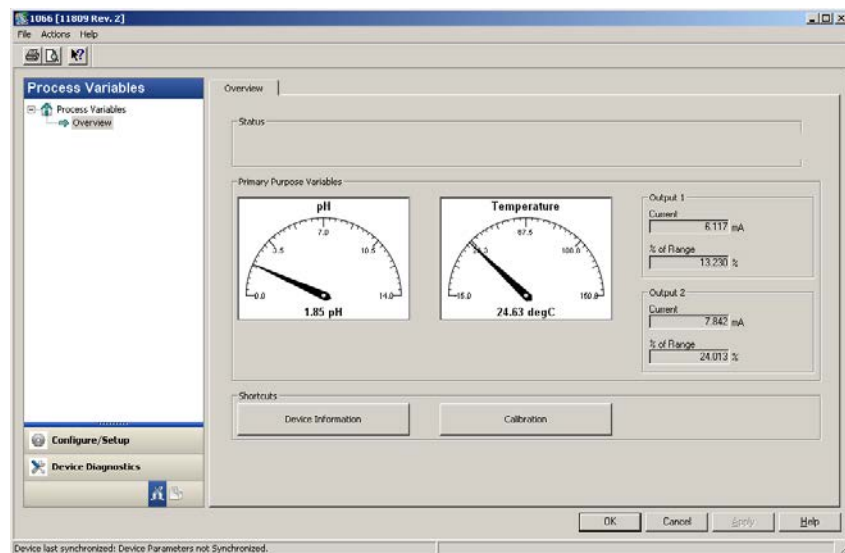

FIGURE 10-4. Device Variables and Dynamic Variables

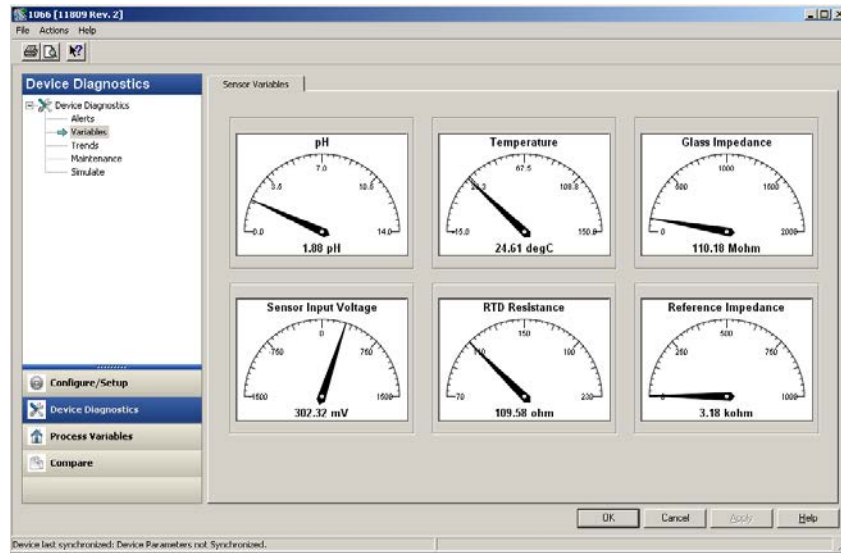

FIGURE 10-5. Diagnostic Messages (Additional Transmitter Status)

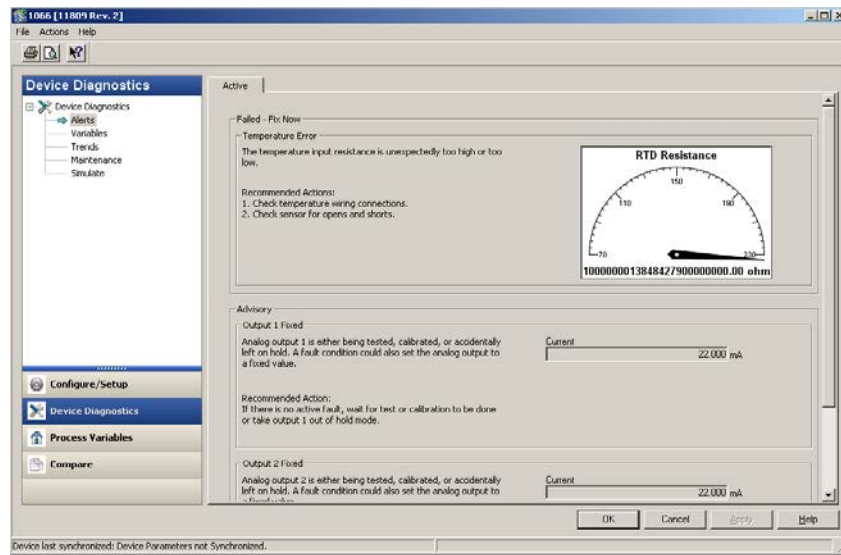

FIGURE 10-6. Configuration

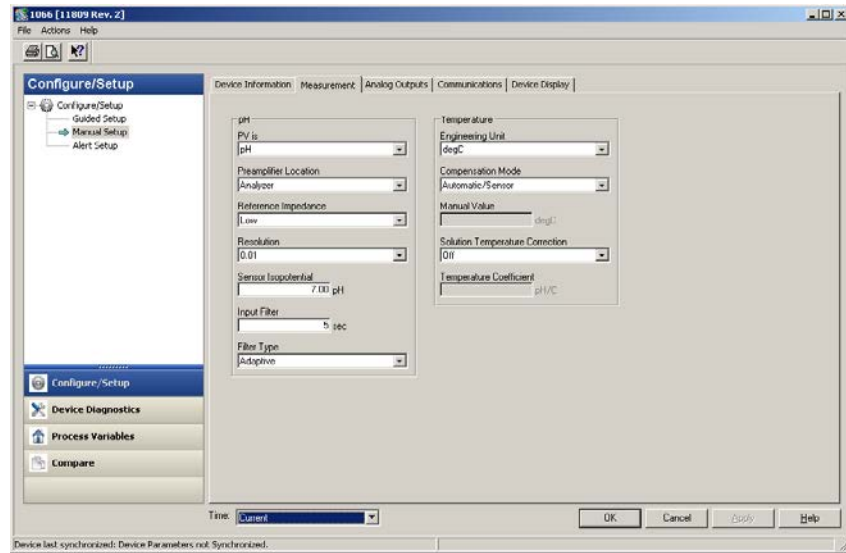
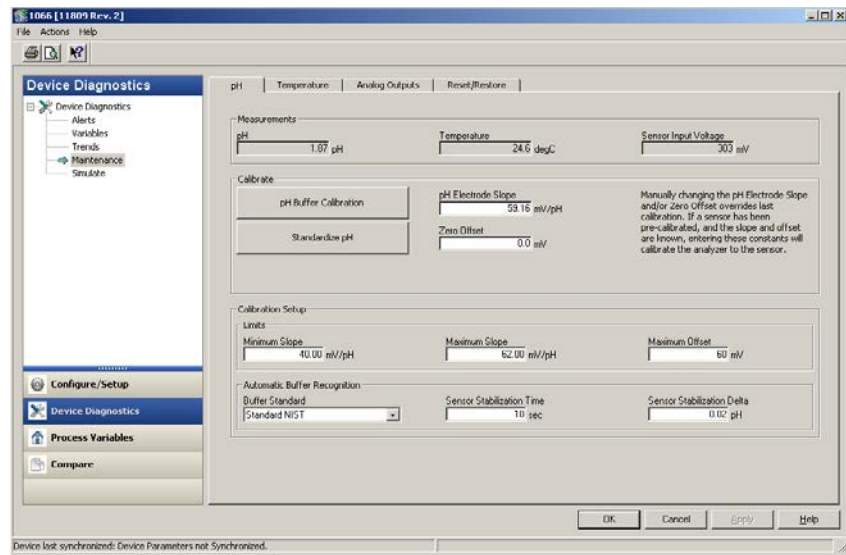

FIGURE 10-7. Calibration



10.5.2 475 Field Communicator

HART (and Fieldbus) devices can be accessed in the field using the 475, which provides the same basic functionality as the AMS Intelligent Device Manager. Asset management information can be uploaded into the AMS database from the 475 for a common database for asset management data. The 475 uses a color menu driven display. The 475 Menu for the 1066 appears in Appendix 10.4.

FIGURE 10-8. 475 Field Communicator



10.6 Wireless Communication using the 1066

The 1066 can communicate by Wireless HART using the Smart Wireless THUM Adaptor and the 1420 Smart Wireless Gateway. All the information available with the wired device can be accessed wirelessly, making it possible to have the measurements and benefits of HART communication in locations where running cable would be difficult or prohibitively expensive.

Although HART 5 or HART 7 can burst the Dynamic Variables (PV, SV, TV, & QV), HART 7 should be used with the THUM because up to 8 Device Variables can be continually burst using Command 9.

FIGURE 10-9. Wireless Communication using the 1066



10.7 Field Device Specification (FDS)

For more details on the implementation of HART in the 1066 and its command structure, the Field Device Specification for the relevant Device Revision should be consulted. They can be downloaded from our website.

APPENDIX 10.1 – Device Variables

1066 pH Device Variables

Device Variable Name	Assignable to Dynamic Variables	Variable Range
Primary Value Type:		
pH (1)	PV, SV, TV or QV	0 to 14 pH
ORP (2)	PV, SV, TV or QV	-1500 to 1500 mV
Redox (3)	PV, SV, TV or QV	-1500 to 1500 mV
Other Device Variables:		
Temperature	SV, TV or QV	-15 to 200 °C
		5 to 360 °F
Sensor mV input	TV or QV	-750 to 750 mV
Sensor Glass impedance	TV or QV	0 to 2000 M μ
Sensor Reference impedance	TV or QV	0 to 10000 k μ

1066C and 1066T Device Variables

Device Variable Name	Assignable to Dynamic Variables	Variable Range
Primary Value Type:		
Conductivity (7)	PV, SV, TV or QV	0 to 2000000 μ S/cm
Resistivity (8)	PV, SV, TV or QV	0 to 50000000 μ -cm
% Concentration:		
NaOH (9)	PV, SV, TV or QV	0 to 12 %
HCl (10)	PV, SV, TV or QV	0 to 15 %
Low H2SO4 (11)	PV, SV, TV or QV	0 to 25 %
High H2SO4 (12)	PV, SV, TV or QV	96 to 99.7 %
NaCl (13)	PV, SV, TV or QV	0 to 25 %
Custom Concentration (14)	PV, SV, TV or QV	0 to 1000 ppm
		0 to 1000 mg/L
		0 to 100 mg/L
		0 to 100 %
		0 to 1000 None
TDS (15)	PV, SV, TV or QV	0 to 10000 ppm
Salinity (16)	PV, SV, TV or QV	0 to 36 ppt
other Device variables:		
Temperature	SV, TV or QV	-25 to 200 °C
		-13 to 360 °F
Temperature resistance	TV or QV	0 to 100000 μ
Conductance	TV or QV	0 to 2000000 μ S
Input resistance	TV or QV	0 to 500 k μ
Raw Conductivity	TV or QV	0 to 2000000 μ S/cm
Raw Resistivity	TV or QV	0 to 50000000 ohm-cm

1066DO Device Variables

Device Variable Name	Assignable to Dynamic Variables	Variable Range
Primary Value Type:		
Oxygen (17)	PV, SV, TV or QV	0 to 100 ppm
		0 to 1000 ppb
		0 to 100 mg/L
		0 to 1000 µg/L
		0 to 300 % Saturation
		0 to 760 mmHg
		0 to 30 inHg
		0 to 1 bar
		0 to 1000 mbar
		0 to 100 kPa
		0 to 1 atm
Other Device Variables:		
Temperature	PV, SV, TV or QV	-15 to 200 °C
		5 to 360 °F
Temperature resistance	TV or QV	0 to 100000 Ω
Sensor input current	PV, SV, TV or QV	0 to 100000 nA

1066OZ Device Variables

Device Variable Name	Assignable to Dynamic Variables	Variable Range
primary value Type:		
Ozone (18)	PV, SV, TV or QV	0 to 20 ppm
		0 to 1000 ppb
		0 to 20 mg/L
		0 to 1000 µg/L
Other Device Variables:		
Temperature	PV, SV, TV or QV	-15 to 200 °C
		5 to 360 °F
Temperature resistance	TV or QV	0 to 100000 µ
Sensor input current	PV, SV, TV or QV	0 to 100000 nA

1066CL Device Variables

Device Variable Name	Assignable to Dynamic Variables	Variable Range
Primary Value Type:		
Chlorine (19)	PV, SV, TV or QV	0 to 20 ppm
		0 to 1000 ppb
		0 to 20 mg/L
		0 to 1000 µg/L
Other Device Variables:		
Temperature	PV, SV, TV or QV	-15 to 200 °C
		5 to 360 °F
Temperature resistance	TV or QV	0 to 100000 Ω
Sensor input current	PV, SV, TV or QV	0 to 100000 nA
pH (free chlorine pH compensation)	SV, TV or QV	0 to 14 pH

APPENDIX 10.2 – Additional Transmitter Status – Command 48 Status Bits

1066 pH Device Variables

Byte / Bit	Meaning / Class	Device Status Bits Set
1 / 0	CPU Error / Error The software checksum is not as expected. The CPU memory has been corrupted.	4 – More Status Available 7 – Field Device Malfunction
1 / 1	Self-Test Fail / Error An electronic component is out of specification.	4 – More Status Available 7 – Field Device Malfunction
1 / 2	Factory Data Error / Error An error was detected in the factory segment of the non-volatile memory. At least one factory configuration parameter has been corrupted.	4 – More Status Available 7 – Field Device Malfunction
1 / 3	Hardware/Software Mismatch / Error The software is not compatible with the hardware.	4 – More Status Available 7 – Field Device Malfunction
1 / 4	Internal Communications Error / Error The analog input electronics is non-responsive.	4 – More Status Available 7 – Field Device Malfunction
3 / 0	Keypad Error / Warning At least one key in the device keypad is stuck. This condition makes the local operator interface unuseable. If no other alerts are present, the device can still perform its other functions normally.	4 – More Status Available
3 / 1	User Data Error / Warning An error was detected in the non-volatile memory. One or more user configuration parameter may be corrupted. Reset analyzer to factory defaults and re-configure the device. If the problem persists, replace device.	4 – More Status Available
3 / 2	Need Factory Calibration / Warning The device's non-volatile memory has been corrupted. The device measurements may be out of specification.	4 – More Status Available
3 / 3	Software Mismatch / Warning The input CPU software is not fully compatible with the main CPU software.	4 – More Status Available
3 / 7	Reset In Progress / Other The transmitter's configuration is being reset to factory defaults.	4 – More Status Available
6 / 6	Maintenance Required / Other	4 – More Status Available
6 / 1	Device Variable Alert / Other	4 – More Status Available
8 / 0	Simulation Active / Mode A device variable is being simulated.	4 – More Status Available
8 / 1	Non-Volatile Memory Defect / Warning	4 – More Status Available
8 / 2	Volatile Memory Defect / Error	4 – More Status Available
8 / 3	Watchdog Reset Executed / Other	4 – More Status Available
8 / 4	Power Supply Condition Out Of Range / Warning	4 – More Status Available
8 / 5	Environmental Condition Out Of Range / Warning	4 – More Status Available
8 / 6	Electronic Defect / Error Reset device or turn power off then on. If problem persists, replace device.	4 – More Status Available

1066 pH Device Variables continued

Byte / Bit	Meaning / Class	Device Status Bits Set
8 / 7	Device Locked / Mode Locked device prevents all host modifications. Unlock device to make changes to the device.	4 – More Status Available
10 / 0	Analog Channel 1 Saturated / Warning The primary variable is outside the analog output range. 1. Check the primary value. 2. Check the analog output scaling.	4 – More Status Available
10 / 1	Analog Channel 2 Saturated / Warning The secondary variable is outside the analog output range. 1. Check the secondary value. 2. Check the analog output scaling.	4 – More Status Available
13 / 0	Analog Channel 1 Fixed / Mode Output 1 is either being tested, calibrated, or accidentally left on hold. A fault condition could also set the analog output to a fixed value. If there is no active fault, wait for test or calibration to end or take Output 1 out of hold mode.	4 – More Status Available
13 / 1	Analog Channel 2 Fixed / Mode Output 2 is either being tested, calibrated, or accidentally left on hold. A fault condition could also set the analog output to a fixed value. If there is no active fault, wait for test or calibration to end or take Output 2 out of hold mode.	4 – More Status Available

Temperature Status Bits

Byte / Bit	Meaning / Class	Device Status Bits Set
0 / 0	Temperature Error / Error The temperature measuring circuit is open or shorted. Check the wiring and the temperature element in the sensor. If the temperature element in the sensor is open or shorted, replace the sensor.	4 – More Status Available 7 – Field Device Malfunction
2 / 0	Temperature High / Warning The measured temperature is above the temperature range of the transmitter and can damage the sensor. The temperature limits are: 1066P / 1066DO, CL, and OZ: Temperature > 150 °C 1066C and 1066T: Temperature > 300 °C 1. Check process temperature. 2. Check sensor and its wiring.	1 – Non-primary Variable out of Limits 4 – More Status Available
2 / 1	Temperature Low / Warning The measured temperature is below the temperature range of the transmitter and can damage the sensor. The temperature limits are: 1066P / 1066DO, CL, and OZ: Temperature < -15 °C 1066C and 1066T: Temperature -25 °C 1. Check process temperature. 2. Check sensor and its wiring.	1 – Non-primary Variable out of Limits 4 – More Status Available
2 / 2	RTD Sense Line Open / Warning The sense line of the temperature sensor is not connected. 1. Check sensor wiring. 2. If a 2-wire RTD is being used for temperature compensation, use wire jumper to connect sense and return terminals.	4 – More Status Available
5 / 1	Temperature Calibration In Progress / Other A temperature calibration is or has been performed.	4 – More Status Available

1066pH/ORP Status Bits

Byte / Bit	Meaning/Class	Device Status Bits Set
0 / 1	Reference Impedance Too High / Error The reference impedance is above the high fault setpoint. The reference electrode may be coated or plugged. 1. Clean or replace the sensor. 2. Check sensor wiring. 3. Increase the setpoint value. 4. Set the reference impedance level to high.	4 – More Status Available 7 – Field Device Malfunction
0 / 2	Glass Impedance Too High / Error The glass impedance is above the high fault setpoint. The glass electrode may be severely coated. 1. Clean or replace sensor. 2. Check sensor wiring. 3. Increase the glass impedance high fault setpoint.	4 – More Status Available 7 – Field Device Malfunction
0 / 3	Broken pH Glass / Error The glass impedance is too low. The glass electrode of the pH sensor may be cracked. 1. Check sensor. Replace sensor if cracks are present. 2. Check sensor wiring. 3. Check preamplifier location configuration.	4 – More Status Available 7 – Field Device Malfunction
2 / 3	pH Voltage Too High / Warning The sensor voltage is outside the expected range for a pH measurement. 1. Check sensor wiring. 2. Replace sensor.	4 – More Status Available
4 / 0	pH Slope Too High / Warning The pH slope calculated during buffer calibration exceeded the maximum slope limit. 1. Check the buffers used and retry buffer calibration. 2. Increase the maximum slope limit (default is 62 mV/pH). Note: A slope of 62 mV/pH or greater indicates that there has been an error made during calibration or a faulty pH sensor. 3. Replace sensor.	4 – More Status Available
4 / 1	pH Slope Too Low / Warning The pH slope calculated during buffer calibration was below the minimum slope limit. The pH electrode may be worn out, damaged, or coated. 1. Check and clean sensor, then retry buffer calibration. 2. Decrease minimum slope limit (default is 40 mV/pH). Note that a pH sensor with a slope less than 50 mV/pH is usually near the end of its useful life. 3. Replace sensor.	4 – More Status Available
4 / 2	Zero Offset Error / Warning The zero offset from a buffer calibration or single point standardization has exceeded the limit. The reference electrode may be poisoned or plugged. 1. Check and clean sensor, then retry buffer calibration. 2. Increase maximum offset limit (default is 60 mV). Note that a pH sensor with an offset of 60 mV or greater is likely poisoned and has to be replaced. 3. Replace sensor.	4 – More Status Available
4 / 3	Calibration Error / Warning	4 – More Status Available
5 / 4	pH Standardization In Progress / Other A pH standardization is being or has been performed.	4 – More Status Available
5 / 5	Buffer Calibration In Progress / Other A pH buffer calibration is being or has been performed.	4 – More Status Available
5 / 6	Stabilization In Progress / Other A pH sensor is stabilizing or has been stabilizing.	4 – More Status Available

1066C and 1066T Status Bits continued

Byte / Bit	Meaning / Class	Device Status Bits Set
2 / 5	<p>Need Zero Calibration / Warning The sensor offset is too high resulting in a negative reading. This trigger point for this alert is dependent upon the conductivity measurement technology: 1066C: (conductance - zero offset) < -2 μS 1066T: (conductance - zero offset) < -50 μS A sensor zero calibration should be performed.</p>	4 – More Status Available
2 / 6	<p>Concentration Out Of Range / Warning The measured concentration is outside the conductivity range where a valid concentration can be derived for the following 5 concentrations: 0 to 20% NaCl 0 to 12% NaOH 0 to 15% HCl 0 to 25% H₂SO₄ 96 to 99.7% H₂SO₄. If there are no other fault conditions check process temperature and check that the actual concentration is outside the range for which curve is defined.</p>	4 – More Status Available
2 / 7	<p>Input Out Of Range / Warning The input is outside the device measurement range. the range limits are: 1066C (2- electrode conductivity): Conductance > 500 mS 1066CT (4- electrode conductivity): (Conductance > 3000 mS) or (V_{cond} < 0mV) 1066T: Conductance > 1500 mS 1. Check sensor wiring. 2. Replace sensor.</p>	4 – More Status Available
4 / 3	<p>Calibration Error / Warning An error occurred in the last calibration procedure. Check sensor and repeat the calibration procedure.</p>	4 – More Status Available
4 / 4	<p>Sensor Zero Error / Warning An error occurred in the last sensor zero procedure. Check sensor and repeat sensor zero procedure.</p>	4 – More Status Available
5 / 2	<p>Sensor Zero In Progress / Other A sensor zero is being or has been performed.</p>	4 – More Status Available
5 / 3	<p>Zero Cal In Water In Progress / Other A zero calibration in water is being or has been performed.</p>	4 – More Status Available
5 / 4	<p>Meter Calibration In Progress / Other A meter calibration is being or has been performed.</p>	4 – More Status Available
5 / 5	<p>Curve Fit In Progress / Other A curve fit is being or has been performed.</p>	4 – More Status Available

1066DO, 1066CL, 1066OZ Status Bits

Byte / Bit	Meaning / Class	Device Status Bits Set
2 / 4	<p>SENSOR_CURRENT > 300 nA for OXYGEN BioRx - Other SENSOR_CURRENT > 800 nA for OXYGEN Brewing SENSOR_CURRENT > 106 uA for OXYGEN Oxygen in Gas SENSOR_CURRENT > 350 nA for Ozone SENSOR_CURRENT > 5 uA for Free Chlorine SENSOR_CURRENT > 40 uA for Total Chlorine SENSOR_CURRENT > 20 uA for Monochloramine</p> <p>1. Make sure the device configuration matches the sensor being used. 2. Check sensor wiring. 3. Replace sensor.</p>	4 – More Status Available
2 / 5	<p>Need Zero Calibration / Warning The sensor offset is too high resulting in a negative reading. The sensor zero limits are: PV < -0.5 if unit is ppm or mg/L PV < -50 if unit is ppb or ug/L PV < -2.0 % for % Saturation PV < -2.0 % for Concentration in Gas PV < -20 ppm for Concentration in Gas PV < -30 mmHg for Partial Pressure Perform sensor a zero calibration.</p>	4 – More Status Available
4 / 3	<p>Calibration Error / Warning There has been a calibration error. Check the sensor.</p>	4 – More Status Available
4 / 4	<p>Sensor Zero Error / Warning An error occurred in the last sensor zero procedure. Check sensor and repeat sensor zero procedure.</p>	
5 / 2	<p>Sensor Zero In Progress / Other A sensor zero is being or has been performed.</p>	4 – More Status Available
5 / 3	<p>Air Cal In Progress / Other An air calibration is being or has been performed.</p>	4 – More Status Available
5 / 6	<p>Stabilization In Progress / Other The sensor is stabilizing or has stabilized.</p>	4 – More Status Available

APPENDIX 10.3 – 1066 HART Configuration Parameters

Parameters Common to All 1066 Transmitters

	Type	Enumeration / Range	Read/Write	Default
input_filter_type Selects between continuous and adaptive filtering of the measurement.	ENUM	Adaptive Continuous	R / W	Adaptive
pv_damping_value Provides the filter time constant.	FLOAT	0.0 -- 99.0 seconds	R / W	0
instrument_software_version The software version of the main processor.	FLOAT		R	
input_software_version The software version of the input processor.	FLOAT		R	
Display Parameters:				
loi_language Selects the language to be displayed by the 1066.	ENUM	English Italiano Français Português Español Chinese Deutsch Russian	R / W	English
loi_warnings Enables or disables the display of transmitter warnings.	ENUM	Enable Disable	R / W	Enable
loi_configuration_code Locks and unlocks access to configuration from the keypad display of the 1066. "000" disables.	UINT (2)		R / W	0
loi_calibration_code Locks and unlocks access to calibration from the keypad display of the 1066. "000" disables.	UINT (2)		R / W	0
loi_main_display_upper Selects the measurement displayed on the upper portion of the main display.	ENUM	Assign PV Blank	R / W	Assign PV
loi_main_display_center Selects the measurement displayed on the center portion of the main display.	ENUM	Compensating pH (free Cl) Temperature PV Blank	R / W	Temperature
loi_main_display_left Selects the measurement or output displayed on the left portion of the display.	ENUM	Valid List per 1066 Model	R / W	
loi_main_display_lower_left Selects the measurement or output displayed on the lower left portion of the display.	ENUM	Valid List per 1066 Model	R / W	
loi_main_display_right Selects the measurement or output displayed on the right portion of the display.	ENUM	Valid List per 1066 Model	R / W	
loi_main_display_lower_right Selects the measurement or output displayed on the lower right portion of the display.	ENUM	Valid List per 1066 Model	R / W	
	1066pH/ORP	Valid List Input mV Glass Impedance Ref Impedance Slope Zero Offset		
	1066C/T	Valid List Raw Conductivity Raw Resistivity		
	1066DO/CL/OZ	Valid List Input Current pH (if free chlorine)		
	All 1066	Valid List AO 1 Current AO 1 % Output AO 2 Current AO 2 % Output		

1066 Temperature Parameters

	Type	Enumeration / Range	Read/Write	Default
rtd_offset The temperature offset resulting from a temperature calibration.	FLOAT		R / W	0
rtd_slope The slope (dimensionless) resulting from a two point temperature calibration. (Valid for cell constants < 0.02 1/cm)	FLOAT		R / W	1
temp_comp_mode Selects automatic or manual temperature compensation.	ENUM	Manual Automatic	R / W	Automatic
manual_temperature If manual temperature compensation is chosen, provides a constant temperature value used by the transmitter.	FLOAT		R / W	25.0 °C

1066 pH/ORP

	Type	Enumeration / Range	Read/Write	Default
zero_offset The zero offset of a pH sensor resulting from a calibration.	FLOAT		R / W	0.0 mV
pH_slope The slope of a pH sensor resulting from a buffer calibration.	FLOAT	40 -- 62 mV/pH	R / W	59.16 mV/pH
zero_offset_limit The maximum value of the zero offset allowed for a successful calibration.	FLOAT		R / W	60
min_pH_slope The minimum value of the slope allowed for a successful calibration.	FLOAT	40 -- 62 mV/pH	R / W	40 mV/pH
max_pH_slope The maximum value of the slope allowed for a successful calibration.	FLOAT	40 -- 62 mV/pH	R / W	62 mV/pH
pH_stabilization_time The period of time used to determine stability of a pH sensor during automatic calibration.	FLOAT	0 -- 99 seconds	R / W	10 seconds
pH_stabilization_value The pH change used to determine stability of a pH sensor during automatic calibration.	FLOAT	0.01 -- 1.0 pH	R / W	0.02 pH
pH_buffer_standard The types of pH buffers available for automatic calibration.	ENUM	Standard / Nist DIN 19267 Ingold Merck Fisher	R / W	Standard / Nist
preamp_location The location of the preamplifier in a pH measurement.	ENUM	analyzer sensor / J-box	R / W	
reference_impedance_level Configures the transmitter to use reference electrodes with impedances less than 500 kohm (low) or greater than 500 kohm (high).	ENUM	Low High	R / W	Low
pH_solution_temperature_correction Configures the transmitter to correct the pH measurement for changes in the pH of the solution with temperature.	ENUM	Off ultra pure water high pH ammonia custom		Off
pH_solution_temperature_coefficient The coefficient used to correct solution pH when using custom solution pH temperature correction.	FLOAT	-9.999 -- 9.999 pH / °C	R / W	0.000 pH / °C

1066 pH/ORP continued

	Type	Enumeration / Range	Read/Write	Default
pH_display_resolution Changes the resolution of the displayed pH value.	ENUM	0.01 pH 0.1 pH	R / W	0.01 pH
pH_sensor_isopotential The pH at which the millivolt output of the pH sensor remains constant with temperature changes; virtually always 7.00 pH.	FLOAT	0.00 -- 14.00 pH	R / W	7.00 pH
refZ_high_fault_setpoint The high setpoint that triggers a reference electrode impedance alert.	FLOAT	0.0 -- 9,999.0 kohm	R / W	500.0 kohm
glassZ_high_fault_setpoint The high setpoint that triggers a glass pH electrode impedance alert.	FLOAT	0.0 -- 9,999.0 Mohm	R / W	1,500 Mohm
diagnostics_switch Turns the glass and reference electrode impedance measurements on and off.	ENUM	Off On	R / W	Off
glassZ_temperature_correction Turns temperature correction of the glass impedance measurement on and off.	ENUM	Off On	R / W	Off
glassZ_measurement_type Toggles between a basic glass impedance measurement, and an advanced impedance measurement that is more accurate.	ENUM	Advanced Basic	R / W	Advanced
calculated_offset The preliminary zero offset calculated by a pH calibration before it is accepted by the transmitter.	FLOAT		R / W	
calculated_slope The preliminary slope calculated by a pH calibration before it is accepted by the transmitter.	FLOAT		R / W	

1066C and 1066T

	Type	Enumeration / Range	Read/Write	Default
conductivity_unit The conductivity unit used by the measurement.	ENUM	μS/cm mS/cm	R / W	μS/cm
cell_constant The cell constant of the conductivity sensor being used, typically determined by calibration.	FLOAT	0.0001-- 100.0 /cm	R / W	1.00 /cm
cable_correction Selects automatic or manual cable resistance correction.	ENUM	Manual Automatic	R / W	Automatic
manual_cable_resistance The known cable resistance used in manual cable correction.	FLOAT	0.0 -- 99.99 ohm	R / W	0.0 ohm
zero_offset_in_air The zero offset determined by a zero calibration in air.	FLOAT		R only	0.0 μS
zero_offset_in_soln The zero offset determined by a zero calibration in a solution.	FLOAT		R only	0.00%
custom_curve_num_data_points The number of conductivity and concentration points to be used to calculate a custom concentration curve.	ENUM	2 3 4 5	R / W	3
Custom Curve Concentration Data Points:				
custom_curve_concentration_1	FLOAT		R / W	
custom_curve_concentration_2	FLOAT		R / W	
custom_curve_concentration_3	FLOAT		R / W	
custom_curve_concentration_4	FLOAT		R / W	
custom_curve_concentration_5	FLOAT		R / W	
Custom Curve Conductivity Data Points:				
custom_curve_conductivity_1	FLOAT		R / W	
custom_curve_conductivity_2	FLOAT		R / W	
custom_curve_conductivity_3	FLOAT		R / W	
custom_curve_conductivity_4	FLOAT		R / W	
custom_curve_conductivity_5	FLOAT		R / W	

1066C

	Type	Enumeration / Range	Read/Write	Default
electrode_type Type of contacting conductivity sensor being used by the transmitter.	ENUM	2-Electrode 4-Electrode	R / W	2-Electrode
cond_range Selects a particular range for the conductivity measurement or automatic ranging for 2 and 4 electrode sensors.	ENUM		R / W	Automatic
	2-Electrode:	Automatic 0-50 μ S 40-500 μ S 400-2000 μ S 1.8-20 mS 18-200 mS		
	4-Electrode:	Automatic 0-42 μ S 36-200 μ S 180-1000 μ S 0.9-10mS/cm 9-600mS/cm		
series_cap_correction Turns capacitance correction on and off.	ENUM	Off On	R / W	Off
cell_factor The second calibration constant used by a 4 electrode sensor in addition to cell constant.	FLOAT		R / W	0.95 /cm
temp_comp_type The type of temperature compensation used by the transmitter.	ENUM	Linear slope Neutral salt Cation Raw / None	R / W	Linear slope
temp_comp_slope Provides a slope value used in linear temperature compensation.	FLOAT	0.2 -- 9.99 % / °C	R / W	2.0% / °C
reference_temperature The temperature that temperature compensation corrects to. It is usually 25 °C.	FLOAT		R / W	25 °C

1066T

	Type	Enumeration / Range	Read/Write	Default
toroidal_sensor_model Selects the model of toroidal sensor being used for enhanced accuracy.	ENUM	228 225 226 247 Other	R / W	228
cond_range Selects a particular range for the conductivity measurement or automatic ranging for toroidal sensors.	ENUM	Automatic 50-600 μ S 0.5-100 mS 90-1500 mS	R / W	Automatic
temp_comp_type The type of temperature compensation used by the transmitter.	ENUM	Linear slope Raw / None	R / W	Linear slope
temp_comp_slope Provides a slope value used in linear temperature compensation.	FLOAT		R / W	2.0% / °C
reference_temperature The temperature that temperature compensation corrects to. It is usually 25 °C.	FLOAT		R / W	25 °C

1066OZ/CL/DO

	Type	Enumeration / Range	Read/Write	Default
polar_voltage The polarization voltage used by the transmitter; automatically set by sensor selection.	FLOAT		R / W	0
temp_coeff The temperature coefficient used to compensate temperature; automatically set by sensor selection.	FLOAT		R / W	0
amp_sensor_sensitivity The response of the sensor to changes in concentration, determined by calibration.	FLOAT	0.1 -- 1,000,000.0 nA/ppm	R / W	2,500 nA/ppm
amp_sensor_zero_current The current output of the sensor when the concentration is 0. It is determined by a zero calibration.	FLOAT	-999.9 -- 999.9 nA	R / W	0.0 nA

1066OZ

	Type	Enumeration / Range	Read/Write	Default
chlorine_type The resolution of the displayed ozone measurement.	ENUM	0.001 0.01	R / W	0.001

1066CL

	Type	Enumeration / Range	Read/Write	Default
chlorine_type The type of chlorine being measured.	ENUM	Free Chlorine Total Chlorine Chloramine	R / W	Free Chlorine
chlorine_resolution The resolution of the displayed chlorine measurement.	ENUM	0.001 ppm 0.01 ppm	R / W	0.001 ppm
pH_correction_mode Turns automatic pH compensation of free chlorine measurements on and off.	ENUM	On Off	R / W	Off
manual_pH Provides a constant pH value, if manual pH compensation of a free chlorine measurement is used.	FLOAT	0.00 -- 14.00 pH	R / W	7.00 pH

1066DO

	Type	Enumeration / Range	Read/Write	Default
oxygen_sensor_type The type of oxygen sensor used.	ENUM	Water/Waste Trace Oxygen BioRx-Rosemount BioRx-Other Brewing Oxygen In Gas	R / W	Water/Waste
oxygen_measurement_type The type of oxygen measurement being made.	ENUM	Concentration in Liquid Percent Saturation Partial Pressure Concentration in Gas	R / W	Concentration in Liquid
oxygen_salinity The salinity of the process solution, which is used by the transmitter to correct for the effect of salinity on the oxygen measurement.	FLOAT	0.0 - 99.9 ppth	R / W	0.0 ppth
pressure_units The units of pressure used by the oxygen measurement.	ENUM	mmHg inHg psi atm kPa mbar bar	R / W	mmHg
oxygen_process_pressure The process pressure used by the transmitter to calculate percent oxygen in gas or % saturation.	FLOAT		R / W	760.0 mmHg
oxygen_air_pressure The barometric pressure used by the transmitter during an air calibration.	FLOAT		R / W	760.0 mmHg
oxygen_units The available units used for the various oxygen measurement types.	ENUM		R / W	
	Concentration in Liquid:	Units: ppm ppb mg/L µg/L		ppm
	Percent Saturation	Units: %		%
	Partial Pressure	Units: mmHg	kPa inHg	mbar psi
	Oxygen In Gas	Units: ppm %		%
air_cal_stabilization_time The period of time used to determine stability of an oxygen sensor during an air calibration.	FLOAT	0 -- 99 seconds	R / W	10 seconds
air_cal_stabilization_value The change in the oxygen measurement used to determine stability of an oxygen sensor during an air calibration.	FLOAT	0.001 -- 9,999.0	R / W	0.05
air_cal_stabilization_value_unit The unit used during an air calibration.	FLOAT		R / W	ppm

APPENDIX 10.4 – 475 Menu Tree for 1066 HART 7

1. Overview

- 1.1. Device Status
- 1.2. Comm Status
- 1.3. PV
- 1.4. SV
- 1.5. Loop Current
- 1.6. % of Range
- 1.7. Find Device
- 1.8. Device Information
 - 1.8.1. Identification
 - 1.8.1.1. Tag
 - 1.8.1.2. Long Tag
 - 1.8.1.3. Model
 - 1.8.1.4. Serial Number
 - 1.8.1.5. Date
 - 1.8.1.6. Descriptor
 - 1.8.1.7. Message
 - 1.8.2. Revision Numbers
 - 1.8.2.1. Universal
 - 1.8.2.2. Field Device
 - 1.8.2.3. DD Revision
 - 1.8.2.4. Hardware
 - 1.8.2.5. Instrument Software
 - 1.8.2.6. Input Software

2. Configure

2.1. Guided Setup

- 2.1.1. Basic Setup

2.2. Manual Setup

2.2.1. Device Information

- 2.2.1.1. Tag
- 2.2.1.2. Long Tag
- 2.2.1.3. Descriptor
- 2.2.1.4. Message
- 2.2.1.5. Date
- 2.2.1.6. Current Date
- 2.2.1.7. Current Time
- 2.2.1.8. Set Date and Time

2.2.2. Measurement (1066 pH/ORP)

- 2.2.2.1. PV is
- 2.2.2.2. Preamp Location
- 2.2.2.3. Soln Temp Correct'n (pH only)
- 2.2.2.4. Temp Coefficient (PV is pH and Soln Temp Correct'n is Custom)
- 2.2.2.5. Resolution (pH only)
- 2.2.2.6. Sensor Isopotential (pH only)
- 2.2.2.7. Input Filter
- 2.2.2.8. Filter Type
- 2.2.2.9. Reference Imp

2.2.3. Measurement (1066 DO)

- 2.2.3.1. Sensor Type
- 2.2.3.2. Measurement Type
- 2.2.3.3. PV Unit
- 2.2.3.4. Salinity
- 2.2.3.5. Pressure Unit
- 2.2.3.6. Input Filter
- 2.2.3.7. Filter Type
- 2.2.3.8. Polar Voltage
- 2.2.3.9. Temp Coefficient

2.2.4. Measurement (1066 Ozone)

- 2.2.4.1. PV Unit
- 2.2.4.2. Resolution
- 2.2.4.3. Input Filter
- 2.2.4.4. Filter Type
- 2.2.4.5. Polar Voltage
- 2.2.4.6. Temp Coefficient

2.2.5. Measurement (1066 Chlorine)

- 2.2.5.1. Measurement Type
- 2.2.5.2. PV Unit
- 2.2.5.3. Resolution
- 2.2.5.4. pH Correction (Free Chlorine Measurement Type only)
 - 2.2.5.4.1. pH Correction
 - If pH Correction is manual
 - 2.2.5.4.2. Manual pH
 - If pH Correction is Live/Continuous
 - 2.2.5.4.3. Preamp Location
 - 2.2.5.4.4. Resolution
 - 2.2.5.4.5. Sensor Isopotential
 - 2.2.5.4.6. Soln Temp Correct'n
- 2.2.5.5. Input Filter
- 2.2.5.6. Filter Type
- 2.2.5.7. Polar Voltage
- 2.2.5.8. Temp Coefficient

2.2.6. Measurement (1066 Contacting & Torridal Conductivity)

- 2.2.6.1. Measurement Type
- 2.2.6.2. PV Unit
- 2.2.6.3. Sensor Config
 - 2.2.6.3.1. Sensor Type (Contacting Model)
 - 2.2.6.3.2. Sensor Model (Toroidal Model)
 - 2.2.6.3.3. Range
 - 2.2.6.3.4. Cell Constant
 - 2.2.6.3.5. Cell Factor (4-Electrode)
 - 2.2.6.3.6. RTD Offset (Cell Constant < 0.02)
 - 2.2.6.3.7. RTD Slope (Cell Constant < 0.02)
- 2.2.6.4. Setup Custom Curve (Custom Curve Measurement)
- 2.2.6.5. Temp Comp
 - 2.2.6.5.1. Temp Comp Type
 - 2.2.6.5.2. Temp Slope
 - 2.2.6.5.3. Reference Temp
- 2.2.6.6. Cable Correction (2-Electrode or Toroidal)
 - 2.2.6.6.1. Series Cap Corr
 - 2.2.6.6.2. Cable R. Correction
 - 2.2.6.6.3. Cable Resistance
- 2.2.6.7. Input Filter
- 2.2.6.8. Filter Type

2.2.7. Temperature

- 2.2.7.1. Temperature Unit
- 2.2.7.2. Temp Comp
- 2.2.7.3. Manual Value (If Temp Comp is Manual)

2.2.8. Analog Outputs

- 2.2.8.1. Output 1
 - 2.2.8.1.1. Primary Variable
 - 2.2.8.1.2. PV URV
 - 2.2.8.1.3. PV LRV
 - 2.2.8.1.4. Scale
 - 2.2.8.1.5. Dampening
 - 2.2.8.1.6. Fault Mode
 - 2.2.8.1.7. Fault Value

- 2.2.8.2. Output 2
 - 2.2.8.2.1. Secondary Variable
 - 2.2.8.2.2. SV URV
 - 2.2.8.2.3. SV LRV
 - 2.2.8.2.4. Scale
 - 2.2.8.2.5. Dampening
 - 2.2.8.2.6. Fault Mode
 - 2.2.8.2.7. Fault Value

2.2.9. Communications

- 2.2.9.1. Burst Message 1
 - 2.2.9.1.1. Burst Message
 - 2.2.9.1.2. Message Content
 - 2.2.9.1.3. Update Rate
 - 2.2.9.1.3.1. Trigger Mode
 - 2.2.9.1.3.2. Trigger Level
 - 2.2.9.1.3.3. Trigger Level Unit
 - 2.2.9.1.3.4. Classification
 - 2.2.9.1.3.5. Update Rate
 - 2.2.9.1.3.6. Default Update Rate
- 2.2.9.2. Burst Message 2
 - 2.2.9.2.1. Burst Message
 - 2.2.9.2.2. Message Content
 - 2.2.9.2.3. Update Rate
 - 2.2.9.2.3.1. Trigger Mode
 - 2.2.9.2.3.2. Trigger Level
 - 2.2.9.2.3.3. Trigger Level Unit
 - 2.2.9.2.3.4. Classification
 - 2.2.9.2.3.5. Update Rate
 - 2.2.9.2.3.6. Default Update Rate
- 2.2.9.3. Burst Message 3
 - 2.2.9.3.1. Burst Message
 - 2.2.9.3.2. Message Content
 - 2.2.9.3.3. Update Rate
 - 2.2.9.3.3.1. Trigger Mode
 - 2.2.9.3.3.2. Trigger Level
 - 2.2.9.3.3.3. Trigger Level Unit
 - 2.2.9.3.3.4. Classification
 - 2.2.9.3.3.5. Update Rate
 - 2.2.9.3.3.6. Default Update Rate
- 2.2.9.4. Event Notification
 - 2.2.9.4.1. Event Message
 - 2.2.9.4.2. Unack Update Rate
 - 2.2.9.4.3. Default Update Rate
 - 2.2.9.4.4. Debounce Interval
 - 2.2.9.4.5. Pending Events
 - 2.2.9.4.6. Acknowledge Event (If there are pending events)
- 2.2.9.5. 12-Point Sample
 - 2.2.9.5.1. Data Sampling
 - 2.2.9.5.2. Device Variable
 - 2.2.9.5.3. Sample Interval
 - 2.2.9.5.4. 12-Point Sample (Data Sampling is not Off)
- 2.2.9.6. Variable Mapping
 - 2.2.9.6.1. PV is
 - 2.2.9.6.2. SV is
 - 2.2.9.6.3. TV is
 - 2.2.9.6.4. QV is
- 2.2.9.7. Multidrop
 - 2.2.9.7.1. Polling Address
 - 2.2.9.7.2. Loop Current Mode

2.2.10. Device Display

2.2.10.1. Main Display Format

2.2.10.1.1. Upper

2.2.10.1.2. Center

2.2.10.1.3. Left

2.2.10.1.4. Lower Left

2.2.10.1.5. Right

2.2.10.1.6. Lower Right

2.2.10.2. Display Language

2.2.10.3. Warnings

2.2.10.4. Display Contrast

2.2.11. Security

2.2.11.1. HART Lock

2.2.11.1.1. Lock State

2.2.11.1.2. Lock/Unlock

2.2.11.2. Local Operator Interface

2.2.11.2.1. Configuration Code

2.2.11.2.2. Calibration Code

2.3. Alert Setup**2.3.1. Diagnostics (1066 pH/ORP/Redox only)**

2.3.1.1. Reference Imp

2.3.1.1.1. High Fault Setpoint

2.3.1.2. Glass Impedance (pH only)

2.3.1.2.1. High Fault Setpoint

2.3.1.2.2. Temp Correction

2.3.1.2.3. Measurement Type

3. Service Tools

3.1. Alerts

3.2. Variables

3.3. Trends

3.4. Maintenance**3.4.1. 1066 DO (1066 Dissolved Oxygen Only)**

3.4.1.1. Oxygen

3.4.1.2. Temperature

3.4.1.3. Input Current

3.4.1.4. Air Calibration

3.4.1.5. Air Calibration Setup

3.4.1.6. Zero Calibration

3.4.1.7. In-Process Cal

3.4.1.8. Sensitivity@25 °C

3.4.1.9. Zero Current

3.4.2. 1066 CL /1066 OZ (1066 Chlorine /1066 Ozone Only)

3.4.2.1. Chlorine/Ozone

3.4.2.2. Temperature

3.4.2.3. Input Current

3.4.2.4. Zero Calibration

3.4.2.5. In-Process Cal

3.4.2.6. Sensitivity@25 °C

3.4.2.7. Zero Current

- 3.4.3. 1066 pH/ORP (pH Only)**
 - 3.4.3.1. pH
 - 3.4.3.2. pH Buffer Calibration
 - 3.4.3.3. Standardize pH
 - 3.4.3.4. pH Slope
 - 3.4.3.5. Zero Offset
 - 3.4.3.6. Calibration Setup
 - 3.4.3.6.1. Limits
 - 3.4.3.6.1.1. Minimum Slope
 - 3.4.3.6.1.2. Maximum Slope
 - 3.4.3.6.1.3. Maximum Offset
 - 3.4.3.6.2. Automatic Buffer Recognition
 - 3.4.3.6.2.1. Buffer Standard
 - 3.4.3.6.2.2. Stable Time
 - 3.4.3.6.2.3. Stable Delta
- 3.4.4. 1066 pH/ORP (ORP/Redox Only)**
 - 3.4.4.1. ORP/Redox
 - 3.4.4.2. Calibrate ORP/Redox
 - 3.4.4.3. Zero Offset
 - 3.4.4.4. Maximum Offset
- 3.4.5. 1066 C/1066 T (1066 Contacting/Torridal Only)**
 - 3.4.5.1. Conductivity
 - 3.4.5.2. Raw Conductivity
 - 3.4.5.3. Temperature
 - 3.4.5.4. Zero Calibration
 - 3.4.5.5. In-Process Calibration
 - 3.4.5.6. Cell Constant
 - 3.4.5.7. Cell Factor (4 electrode)
 - 3.4.5.8. Zero Offset
 - 3.4.5.9. Soln Offset (%Concentration)
- 3.4.6. Temperature**
 - 3.4.6.1. Temperature
 - 3.4.6.2. Calibrate Temp
 - 3.4.6.3. RTD Offset
- 3.4.7. Analog Outputs**
 - 3.4.7.1. Output 1
 - 3.4.7.1.1. Loop Current
 - 3.4.7.1.2. Calibrate Output 1
 - 3.4.7.2. Output 2
 - 3.4.7.2.1. SV Current
 - 3.4.7.2.2. Calibrate Output 2
- 3.4.8. Meter**
 - 3.4.8.1. Input Resistance
 - 3.4.8.2. Meter Calibration
- 3.4.9. Reset/Restore**
 - 3.4.9.1. Reset Device
 - 3.4.9.2. Load Default Configuration
 - 3.4.9.3. Reset Configuration Changed
- 3.5. Simulate**
 - 3.5.1. PV (show current PV type label)
 - 3.5.2. Temperature
 - 3.5.3. End Variable Simulation (If any variable is being simulated)
 - 3.5.4. Output 1
 - 3.5.5. Output 2

Section 11: Return of Material

11.1 General

To expedite the repair and return of instruments, proper communication between the customer and the factory is important. Before returning a product for repair, call 1-949-757-8500 for a Return Materials Authorization (RMA) number.

11.2 Warranty Repair

The following is the procedure for returning instruments still under warranty:

1. Call Emerson for authorization.
2. To verify warranty, supply the factory sales order number or the original purchase order number. In the case of individual parts or sub-assemblies, the serial number on the unit must be supplied.
3. Carefully package the materials and enclose your "Letter of Transmittal". If possible, pack the materials in the same manner as they were received.
4. Send the package prepaid to:

Emerson
8200 Market Blvd,
Chanhassen, MN 55317
Attn: Factory Repair
RMA No. _____
Mark the package: Returned for Repair
Model No. _____

IMPORTANT

Please see second section of "Return of Materials Request" form. Compliance with the OSHA requirements is mandatory for the safety of all personnel. MSDS forms and a certification that the instruments have been disinfected or detoxified are required.

11.1 Non-Warranty Repair



The following is the procedure for returning for repair instruments that are no longer under warranty:

1. Call Emerson for authorization.
2. Supply the purchase order number, and make sure to provide the name and telephone number of the individual to be contacted should additional information be needed.
3. Do Steps 3 and 4 of [Section 10.2](#).

NOTICE

Consult the factory for additional information regarding service or repair.

Note: Please see [website](#) for most recent Declaration.

	EU Declaration of Conformity (No. 1700905)	
		1066-AA-BB-CC
This declaration is issued under the sole responsibility of the manufacturer: Rosemount Inc., 8200 Market Blvd., Chanhassen, MN 55317 USA		
The product, Rosemount Smart-enabled, 2-wire Transmitter model 1066-AA-BB-CC		
Where, AA is Measurement: P pH/ORP measurement CL Chlorine measurement DO Dissolved Oxygen measurement OZ Ozone measurement C Contacting Conductivity measurement T Toroidal Conductivity measurement	BB is Communication: HT Analog/HART communication FF Fieldbus communication FI FISCO communication	CC is Agency Approval: 60 None 67 Labelled for FM 69 Labelled for CSA 73 Labelled for ATEX/IECEX
to which this declaration relates, is in conformity with relevant Union harmonization legislation:		
(2014/30/EU) EMC Directive		
(2014/34/EU) ATEX Directive (The ATEX Directive is only valid if option 73 is selected)		
Provisions of the directive fulfilled by the equipment: Equipment Group II, Category I G Ex ia IIC T4 Ga (-20°C ≤ Ta ≤ +65°C) Intrinsically Safe, EC Type Examination Certificate: Baseefa11ATEX0195X Special Condition for use: The plastic enclosure, excluding the front panel, may constitute a potential electrostatic ignition risk and must only be cleaned with damp cloth.		
ATEX Notified Body for EC Type Examination Certificate & Quality Assurance: SGS Baseefa[Notified Body Number:1180], Rockhead Business Park, Staden Lane, Buxton SK17 9RZ UNITED KINGDOM		
Assumption of conformity is based on the application of the harmonized standards: EN 61326-1:2006 Electrical equipment for measurement, control and laboratory use. EMC requirements. General requirements EN 60079-0:2012+A11:2013 Explosive atmospheres. Equipment. General requirements EN 60079-11:2012 Explosive atmospheres. Equipment protection by intrinsic safety "i"		
 <hr/> (Signature) Kim Freeman (Name printed)	Director of Global Quality (Function name) March 23, 2017 (Date of issue)	
CE marking was first affixed to this product in 2011		

www.Emerson.com/RosemountLiquidAnalysis



[Youtube.com/user/Rosemount](https://www.youtube.com/user/Rosemount)



Analyticexpert.com



[Twitter.com/Rosemount_News](https://twitter.com/Rosemount_News)



facebook.com/Rosemount

Emerson

8200 Market Blvd.
Chanhassen, MN 55317,
USA

Tel +1 800 999 9307
Fax +1 952 949 7001

Liquid.CSC@Emerson.com

©2017 Emerson. All rights reserved.

The Emerson logo is a trademark and service mark of Emerson Electric Co. Rosemount is a mark of one of the Emerson family of companies. All other marks are the property of their respective owners.

The contents of this publication are presented for information purposes only, and while effort has been made to ensure their accuracy, they are not to be construed as warranties or guarantees, express or implied, regarding the products or services described herein or their use or applicability. All sales are governed by our terms and conditions, which are available on request. We reserve the right to modify or improve the designs or specifications of our products at any time without notice.