

DISCRETE VALVE CONTROLLERS

POSITION MONITORING AND CONTROL OF AUTOMATED ON/OFF VALVES

- Suitable for use on rotary and linear applications
- Certified for use in all hazardous areas
- Integrated solutions (bus + sensors + pilot)
- Technology leadership in fieldbus networks



TOPWORX

EMERSON[™]
 Process Management



TopWorx™, a business within Emerson™ Process Management, is a global leader in on/off valve control and position monitoring for the process industries. Our solutions enable plants, platforms, and pipelines to manage and control operations more intelligently and efficiently under the most demanding and extreme conditions.

GLOBAL TECHNOLOGY LEADERSHIP

TopWorx™ technology advancements are at the forefront of innovation in the process automation industry. TopWorx™ uses wireless technologies and fieldbus protocols such as FOUNDATION Fieldbus, DeviceNet, AS-Interface, Profibus, and HART to reduce installation costs and enable predictive maintenance.

GLOBAL HAZARDOUS AREA CERTIFICATIONS

In addition to high temperature (175°C), cold temperature (-60°C), and sub-sea (6,800 meters) applications, TopWorx™ products are suitable for use in Flame-proof/Explosion Proof, Non-Incendive, and Intrinsically Safe hazardous areas with IECEx, ATEX, EAC, InMetro, UL, CSA, KOSHA, and NEPSI certifications.

GLOBAL SERVICE & SUPPORT

With company locations in the United States, United Kingdom, South Africa, Bahrain, and Singapore, TopWorx™ is strategically positioned to provide outstanding support. In addition, over 200 Certified Product Partners throughout the world are available to provide competent local support when needed.



WWW.TOPWORX.COM

Visit www.topworx.com for comprehensive information on our company, capabilities, and products – including model numbers, data sheets, specifications, dimensions, and certifications.



TopWorx™ discrete valve controllers enable automated on/off valves to communicate via FOUNDATION Fieldbus, DeviceNet, AS-Interface, Profibus, HART and Wireless HART protocols. They attach to all rotary and linear valves and actuators, operate in the most demanding environmental conditions, and carry a variety of hazardous area certifications.

Discrete Valve Controllers for:

- Any bus network
- Any hazardous area
- Any valve or actuator
- Anywhere in the world

TopWorx™ valve control solutions deliver on today's new customer requirements. With the TopWorx™ program, customers enjoy:

- A complete line of valve controllers and monitors for every protocol, application, environment, and hazardous area.
- The world's leading selection of valve networking products, including FOUNDATION Fieldbus, DeviceNet, AS-Interface, Profibus, and Wireless HART.
- The most reliable and durable valve position sensor on the planet.
- On/Off valve control and indication through wireless technology.
- Quality products with global agency approvals including IECEx, ATEX, CE, UL, CSA, as well as NEPSI, KOSHA, InMetro, and EAC.
- The unmatched process experience and bus networking expertise of TopWorx™, the leading provider of valve control and position sensing solutions for the process industries.

TOPWORX™ D-SERIES

World-Class Discrete Valve Controllers with the Highest Technology Available

TopWorx™ D-Series discrete valve controllers are certified for use in every world area. They carry IECEx, ATEX, and UL certifications in a single model, making it easier for global customers to standardize across plants in multiple world areas. Other certifications available include NEPSI, KOSHA, InMetro, and EAC.

D-Series discrete valve controllers can survive in virtually any plant condition. Their heavy-duty construction and corrosion resistance enable superior performance in the most demanding applications.

The D-Series is Built Tough!

Designed to provide reliable service for a lifetime, the D-Series has been built to last in the most demanding applications, and endurance tested for over 3.5 million cycles to prove it.



Wet

Tested against intense water pressure blasts and complete submersion underwater for 96 hours at a depth of 30 meters.

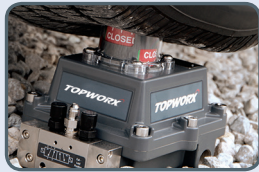

Hot

Tested for long-term functionality in temperatures up to 176°F/80°C



Cold

Tested for endurance in temperatures down to -76°F/-60°C

Dirty

Tested in dust chamber and proven dust tight

Abusive

Tested against the “300 pound man step test” and proven impact and step resistant

Corrosive

Tested against hundreds of corrosive and caustic elements and proven to resist deterioration or chipping

Explosive

Tested by UL and Sira for use in explosive environments with no seal-off fittings required (DXP, DXS)

Chemical Compatibility

Tested against hundreds of chemicals with varying exposure times, temperatures, and concentrations. Please contact factory for compatibility information.



“ I like the fact that the D-Series has world wide approvals since we have projects throughout the world. ”

- **Project Engineer, Global Engineering Firm**



Visual Display

- Impact resistant polycarbonate
- Intuitive colors (Green/Red)
- Adjustable/customizable
- Pre-adjusted to 90° for easy installation
- Less than 1 3/4" tall

Bus Networking / Sensor options

- FOUNDATION, DeviceNet, AS-Interface, HART
- GO™ Switch, Proximity, P+F™, Mechanical, 4-20mA Transmitter

Stainless Steel Shaft & Fasteners

- 1/4" DD or NAMUR Shaft
- Captive cover bolts
- Captive dome screws



Rugged Enclosures for every environment

- Aluminum, Composite, Stainless
- Up to four conduit entries (English or Metric)
- O-ring seals everywhere
- Buna, Silicone o-ring options

Pilot Valves

- Aluminum, 316 Stainless Steel available
- Low Power Solenoid or Ultra-Low Power Piezo
- Single or Dual Coil
- 1.2 Cv or 3.0 Cv
- Integrally mounted for extra protection
- Built-in filter protects the pilots against debris
- Fast, easy troubleshooting:
 - Pneumatic tubing is color-coded for trouble shooting while system is pressurized
 - Troubleshoot valve without removing the cover

Environmental extremes

- Rated for environments from -76°F/-60°C to 347°F/175°C
- NEMA Type 4, 4X, IP66/67

MULTIPLE D-SERIES PLATFORMS FOR EVERY ENVIRONMENT



DXP

Tropicalized Aluminum
 Flameproof/Explosion Proof/Intrinsically Safe
 Class I Division 1 Groups A-D
 Class I Division 2 Groups A-D
 Class II Division 2 Groups F and G
 Ex ia IIC T4 Tamb
 -50°C to +50°C
 Ex d IIB+H2 T6...T3 Tamb
 -60°C to +175°C
 Ex d IIC T6...T3 Tamb
 -60°C to +175°C
 Ex tb IIIC T135°C Tamb
 -50°C to + 110°C
 II2GD, IP66/67, Type 4X



DXS

316 Stainless Steel
 Flameproof/Explosion Proof
 /Intrinsically Safe
 Class I Division 1 Groups A-D
 Class I Division 2 Groups A-D
 Ex ia IIC T6 Tamb
 -50°C to 50°C
 Ex d IIB+H2 T6...T3 Tamb
 -60°C to +175°C
 Ex tb IIIC T135°C Tamb
 -50°C to + 110°C
 II2GD, IP66/67, Type 4X

SIL-3
IEC 61508



D-ESD

Partial Stroke Testing for
 Emergency Shutdown Valves
 Suitable for use in SIL-3 applications
 Stainless, Aluminum, or Resin
 Flameproof/Explosion Proof
 /Non-Incendive
 Class I Division 1 Groups C & D
 Class I Division 2 Groups A-D
 Ex d IIB+H2 T6 Tamb -50°C
 to +60°C
 Ex tb IIIC T135°C Tamb
 -50°C to + 110°C
 II2GD, IP66/67, Type 4X



DXR

Composite Resin
 Non-Incendive/Intrinsically Safe
 Class I Division 2 Groups A-D
 Class II Division 2 Groups F & G
 Ex ia IIC T6 Tamb
 -20°C to 50°C
 Ex e mb IIC
 -20°C to 44°C T4
 Ex tb IIIC T66C II2D
 II2GD, IP67, Type 4X

TOPWORX™ T-SERIES

High-Value Switchboxes with a Variety of Options

TopWorx™ T-Series switchboxes deliver outstanding value by providing full functionality in compact, direct-mount enclosures.

Available with a variety of position sensors, integral solenoid valves, and bus networks, the T-Series is suitable for use in all hazardous areas and carry IECEx, ATEX, and UL certifications.

The TopWorx™ T-Series Delivers Outstanding Value!

Designed to provide maximum functionality in a compact form factor, the TopWorx™ T-Series has a number of unique features that save space, time, and money.

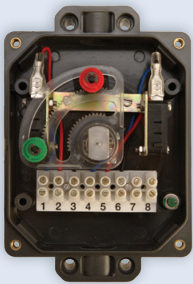

Optimum Use of Space

The unique layout supplies ample working space inside the enclosure for wiring and setting of the switches while taking up very little space above the actuator.



TwistSet™ Cams

Unique TwistSet cam design allows easy access and accurate stepless setting of sensor position with minimum hysteresis.

Color-coded strikers enable quick identification of open/closed switches.

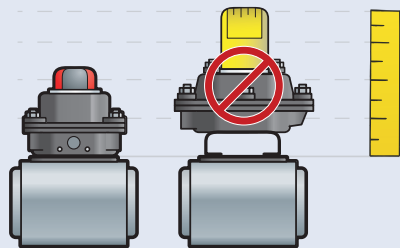

Low Profile Design

The unique direct-mounting feature eliminates expensive mounting brackets while reducing the height of the switchbox and the overall footprint above the actuator.

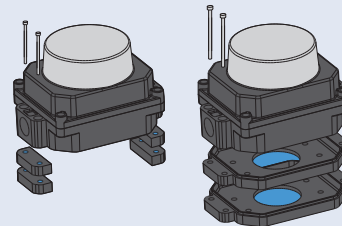

Direct Mounting

Unique mounting design enables simple attachment to any ISO/NAMUR actuator without the need for expensive mounting brackets.



“I like the features of the T-Series products. The direct mount feature saves money on the cost of brackets.”

- President, Valve Distributor



Solid Enclosures for Every Environment

- Aluminum, Composite, Stainless
- Up to four conduit entries (English or Metric)
- O-ring seals everywhere

Environmental Extremes

- Operating temperatures from -76°F/-60°C to +175°F/80°C
- NEMA 4, 4X, IP66/67

Pilot Valves

- Low Power Solenoid
- Single Coil
- 1.0 Cv
- Integrally mounted for extra protection



Visual Display

- Impact resistant polycarbonate
- Intuitive colors (Green/Red)
- Pre-adjusted to 90° for easy installation
- Low profile/High visibility
- Customizable

Bus Networking / Sensor Options

- AS-Interface, Profibus
- GO Switch, Proximity, P+F, Mechanical

Stainless Steel Shaft and Fasteners

- NAMUR Shaft
- Captive cover bolts and indicator screws

MULTIPLE T-SERIES PLATFORMS FOR EVERY ENVIRONMENT



TVA | Direct-Mount Composite Resin
Intrinsically Safe
General Purpose
Ex ia IIC T4 II2G
Tamb -40°C to 60°C

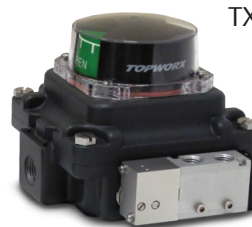

TXP | Direct-Mount Aluminum
Flameproof/Intrinsically Safe/
Explosion Proof /Non-Incendive
Class I Division 1 Groups C & D
Class I Division 2 Groups A-D
Class II Division 1 Groups E-G
Class II Division 2 Groups F and G
Ex ia IIC T4 Tamb -50°C to 85°C
Ex d IIB T4 Tamb -60°C to 80°C
Ex d IIC T4 Tamb -60°C to 80°C
Ex tb IIIC T135C Tamb -50°C to 80°C
II2GD, IP66/67, Type 4X



TXS | Direct-Mount Stainless Steel
Flameproof/Intrinsically Safe/
Explosion Proof /Non-Incendive
Class I Division 1 Groups C & D
Class I Division 2 Groups A-D
Class II Division 1 Groups E-G
Class II Division 2 Groups F and G
Ex ia IIC T4 Tamb -50°C to 85°C
Ex d IIB T4 Tamb -60°C to 80°C
Ex d IIC T4 Tamb -60°C to 80°C
Ex tb IIIC T135C Tamb -50°C to 80°C
II2GD, IP66/67, Type 4X

TOPWORX™ TV-SERIES

High-Value Switchboxes with a Variety of Options

Compact, rugged, and dependable solution for discrete valve control and valve position monitoring where weight and real estate are at a premium. Light weight and robust enclosures specially designed for non-incendive, intrinsically safe and general purpose application. Each enclosure is suited for heavy wash down and corrosive environments and IP66/68 tested.



Light, Rugged and Compact Enclosure

- Aluminum, Stainless or Aluminum base with clear polycarbonate options
- (2) M20, M25, 1/2NPT, or 3/4NPT conduit options
- Direct ISO/NAMUR mount
- Silicone seals everywhere

Up to (4) Four Sensors Inside

- Mechanical –SPDT or DPDT
- Inductive
- Proximity
- NAMUR

Stainless Steel Shaft and Fasteners

- NAMUR Shaft
- Captive cover bolts and indicator screws



Environmental Extremes

- Operating temperatures from -58°F/-50°C to + 185°F/95°C
- NEMA Type 4, 4X

Visual Display

- Impact resistant polycarbonate
- Pre-adjusted to 90° for easy installation
- Intuitive colors
- Customizable

Pilot Valves

- Low or high power solenoid options
- Single of dual coil—single acting or double acting actuators
- Aluminum or Stainless Steel spool valve options

MULTIPLE TV-SERIES PLATFORMS FOR EVERY ENVIRONMENT



TVH | Stainless Steel
Intrinsically Safe/Non-Incendive
Class I & II Division 1 & 2
Ex ia IIC T4
Ex tb IIIC T135°C
Tamb -50°C to +85°C
Ex nA nC IIC T4
Tamb -40°C to +95°C

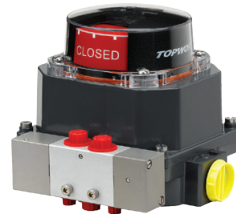

TVL | Tropicalized Aluminum
Intrinsically Safe/Non-Incendive
Class I & II Division 1 & 2
Ex ia IIC T4
Ex tb IIIC T135°C
Tamb -50°C to +85°C
Ex nA nC IIC T4
Tamb -40°C to +95°C

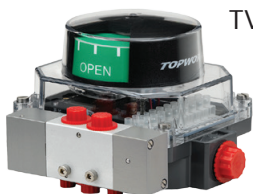

TVF | Tropicalized Aluminum Base with Polycarbonate Lid
Intrinsically Safe/Non-Incendive
Class I & II Division 1 & 2
Ex ia IIC T4
Tamb -20°C to +40°C

TOPWORX™ BUS NETWORKS

Connectivity to Every Fieldbus Network

SENSOR-COMMUNICATION MODULES

TopWorx™ Sensor-Communication Modules are microprocessor based 'brains' that mount inside TopWorx™ enclosures to deliver position sensing and bus networking functionality to on/off valves. They combine position sensors, bus communications, solenoid outputs, and wiring terminals into a compact, sealed module that drops into various TopWorx™ enclosures.

SCM Features:

- Short-circuit protection
- Resistant to impact, moisture, shock, vibration, contamination
- LEDs indicate valve position and facilitate sensor set-up



BUS NETWORKS

TopWorx™ Sensor-Communication Modules make it easy to connect automated on/off valves to modern bus networking protocols such as FOUNDATION Fieldbus, DeviceNet, AS-i interface, Profibus, and HART.

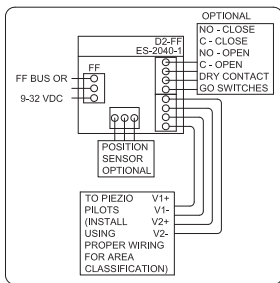

FOUNDATION Fieldbus

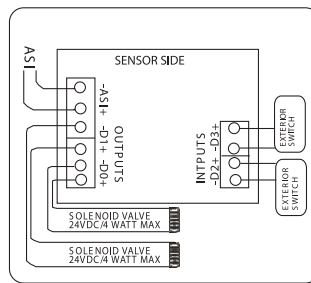

ASi

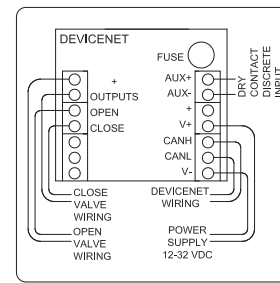

DeviceNet

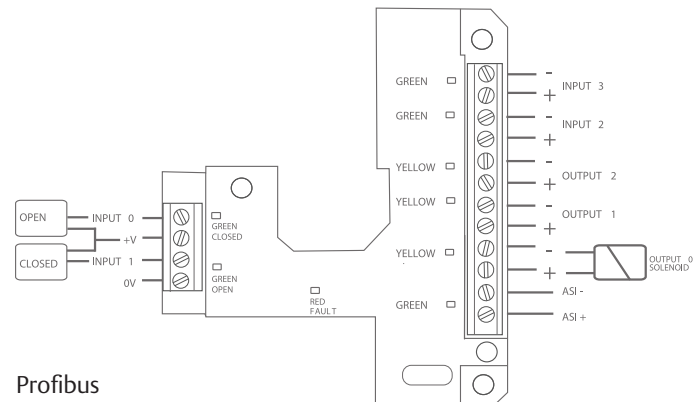

Profibus



FOUNDATION FIELDBUS

- Factory programmed with: (2) DI, (1) DO, (1) AI, (1) PID, with the ability to add any additional 10 function blocks.
- Emerson DeltaV, Honeywell, Yokogawa, ABB, Invensys approved
- Pre-defined templates, on-board diagnostics, and EDDL-enhanced on-board diagnostics.
- Consumes only 17mA to operate, reduces VCRs and DSTs required
- Local calibration button for factory setting of GO switches.
- Position feedback via DO read back reduces number of function blocks.

BEST-IN-CLASS CAPABILITIES

- Reduced macrocycle times with 15 to 20ms block execution times
- Reduced VCR Links (Publisher/Subscriber)
- ITK 6.0 registered guaranteeing the latest advancements in field diagnostics per NAMUR NE 107, with 17 diagnostics and alerts.
- Live updates without process interruptions - Device Descriptions (DD's) can be updated without taking the device offline.
- Link Active Scheduler (LAS) capable, allowing for communication backup.

MONITORING FEATURES

- The two built in cycle counters, a life cycle counter and adjustable counter, with high limit alarm that gives the user needed information to implement a preventative maintenance strategy.
- With built in timers that record valve time in open position, open travel time, and close travel time allowed for failure prediction by trending opening and closing times.

CALIBRATION SWITCH

The D2-FF is equipped with a local calibration button for pre-installation function testing of the valve actuator package. This ensures that all valve automators can function test packages before installation without having to purchase expensive test equipment. LEDs indicate correct position setting of the switches.

ASCO® PIEZO TECHNOLOGY

TopWorx™ discrete valve controllers incorporate the best piezo technology available on the market today. With a response time of under 50mS and a high flow rate, we ensure the spool valve reacts immediately to a change in signal.

DeviceNet

- 3 Discrete Inputs, 2 Discrete Outputs, 1 Analog Input
- Rockwell, Emerson DeltaV approved
- On-board diagnostics and early warning LEDs



- ASi 2.1 with up to 4 Discrete Inputs and 3 Discrete Outputs
- Early warning LEDs



- Profibus DP V0
- 4 Discrete Inputs 2 Discrete Outputs
- Early warning LEDs



- Digital confirmation of analog signal
- Auto-calibration via handheld



TOPWORX™ POSITION SENSORS

The Industry's Leading Selection of Position Sensors

TopWorx™ provides the industry's leading selection of valve position sensors, including GO™ Switch leverless limit switches, proximity sensors, mechanical limit switches, potentiometers, and 4-20mA position transmitters.

All in one proximity sensor and limit switch

GO Switches are hermetically sealed to outperform all other position sensors in hot, cold, wet, dirty, abusive, corrosive, and explosive conditions. GO Switches deliver best-in-class capabilities:

- Highest amp rating (4amp/120vac, 3amp/24vdc)
- Highest temperature rating: 80°C
- Up to four GO Switches inside
- Hermetically Sealed contacts
- SPDT, DPDT, and Stainless Steel options
- Proximity operation – nothing to jam, bend, break, or wear out
- Resistant to electrical noise, radio frequency interference, dust, dirt, and most chemicals
- No leakage current, not voltage or polarity sensitive
- Simple device – inherently intrinsically safe with barrier
- Unlike Reed Switches, Gold flashed contacts allow for use in both low and high current applications within a single switch



SENSORS & SWITCHES

- GO™ Switch leverless limit switches
- 4-20mA position transmitters with HART protocol
- Proximity
- Reed
- Mechanical

PUSHSET CAM

Unique pushset cam design allows quick and accurate setting of the GO Switch positions reducing deadband and hysteresis to a minimum. Switches

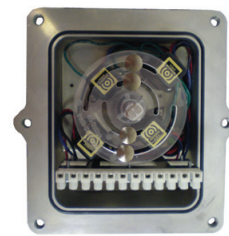

can easily be set in the mid-position for control applications such as 3-way ball valves or diverter valves.

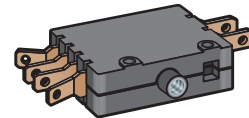
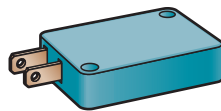
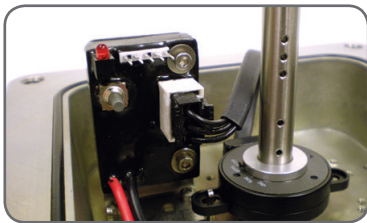

4-20mA POSITION TRANSMITTER

- Fully potted electronic module with LEDs and Auto Calibration feature
- Precise setting of the zero and span can be done in seconds for both CW and CCW rotation with a simple push button
- Position feedback sensor is mounted directly to the switchbox shaft eliminating backlash caused by traditional gear train
- Up to 300° rotation for choke valve applications
- The need for re-calibration is eliminated
- Available with GO Switches and HART Protocol

PROXIMITY SENSORS

- Choose from a variety of proximity sensors including reed switches and inductive proximity sensors such as Pepperl+Fuchs™ and others.
- Up to 6 proximity sensors
 - AC, DC, Namur versions available

MECHANICAL LIMIT SWITCHES

- Up to 6 mechanical switches
- 15A/120vac
- SPDT and DPDT contacts available
- Up to 6 mechanical switches

TOPWORX™ PILOT VALVES

Solenoid Valves to Pilot Any Actuator



TopWorx™ provides a portfolio of self-contained pilot valves to control pneumatic actuators. These compact, high flow spool valves are all low power and can deliver significant operating cost savings. Integral pilot valve options include solenoid and piezo pilots, aluminum and 316 or 304 stainless steel valve bodies, and pushbutton or palm actuated manual overrides.

- SOLENOID VALVES**
- 24vdc, 120vac, 220vac
 - Aluminum, 316 Stainless, 304 Stainless
 - Single Coil, Dual Coil, Blocked Center
 - High Flow up to 3.0Cv
 - Low Power Consumption (solenoid 0.5 watts; piezo 12mw)

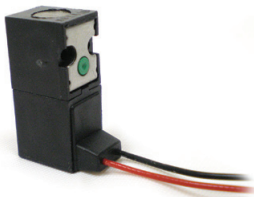

PILOTS

- Internally mounted for protection from the environment
- Low Power Solenoid or Ultra-Low Power Piezo pilots
- Single or Dual Pilots
- Fail open, Fail closed, Fail in last position
- 50 million cycle minimum life
- Class F coil insulation (Class H available on request)
- Response time 10mS



VALVE BODIES

- Anodized Aluminum
- 316 Stainless Steel
- 304 Stainless Steel

Flow Rates

- 1.2 Cv
- 3.0 Cv



MANUAL OVERRIDES

- Momentary
- Latching
- Manual Reset
 - Prevents accidental opening of a tripped ESD valve
 - Local operator intervention is required before valve can be re-opened



DUAL VALVE

- Two integral solenoid valves configured in series or parallel
- For applications where a redundant solenoid is required
- For ESD valves or control of 3-position actuators

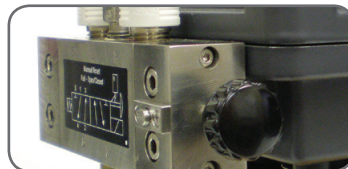

MANUAL RESET SOLENOID VALVE

- Designed for Critical Service or Emergency Shutdown Valve applications which often require operators to manually verify a system prior to restarting a process
- Features a 1.2 Cv flow rate and rugged 316 stainless steel housing, ideal for offshore applications

How It Works

- The pushbutton on the Manual Reset solenoid valve is manually pushed and latched. The inward movement of the pushbutton causes the valve to shift.
- The pilot is then energized, which unlatches the manual pushbutton, but does not change the valve state.
- When the coil is de-energized, the valve is returned to its original fail-safe mode.

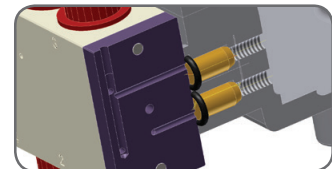

FLAME ARRESTORS

These double as in line filters, protecting the pilot against damage caused by dirty air. This design also allows the users to replace or work on the external valve in situ without affecting the integrity of the explosion proof enclosure.

TOPWORX™ D-ESD

SIL-3 Partial Stroke Test Solutions

TopWorx™ SIL-3 ESD Valve Controllers provide a complete Partial Stroke Test Solution with unique features and functionality that enable partial stroke testing of emergency shutdown valves without disrupting or shutting down the process.

The **TopWorx™ Partial Stroke Test Solution** comes complete with:

- Sensor Control Module to partially close the valve without disrupting the process
- Pass/Fail indication via high/low response on the return signal
- Open and Closed position sensors for feedback to the DCS or PLC
- Onboard Diagnostics to enable predictive maintenance and early-warning alerts
- Aluminum, Composite, and 316 Stainless Steel platforms certified for use in Flameproof/Explosion Proof, or Non-Incendive hazardous areas
- An optional local, lockable partial stroke Test Button integral to the unit

The **TopWorx™ Partial Stroke Test Solution** provides Onboard Diagnostics to alert the user to the following Dangerous Failures:

- Valve packing/shaft damage
- Actuator spring fatigue/breakage
- Solenoid pilot exhaust blockage
- Solenoid spring failure



Convenient Partial Stroke Testing

Partial Stroke Test Module

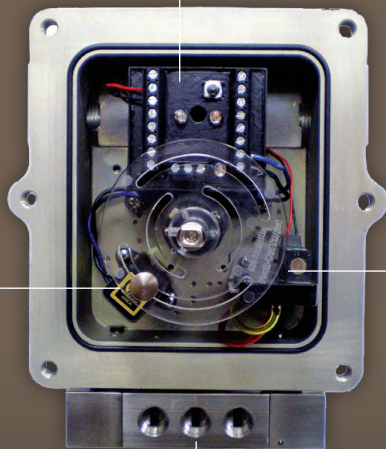

GO™ Switch
Partial Stroke Confirmation Switch

Integral Solenoid

Spool Valve

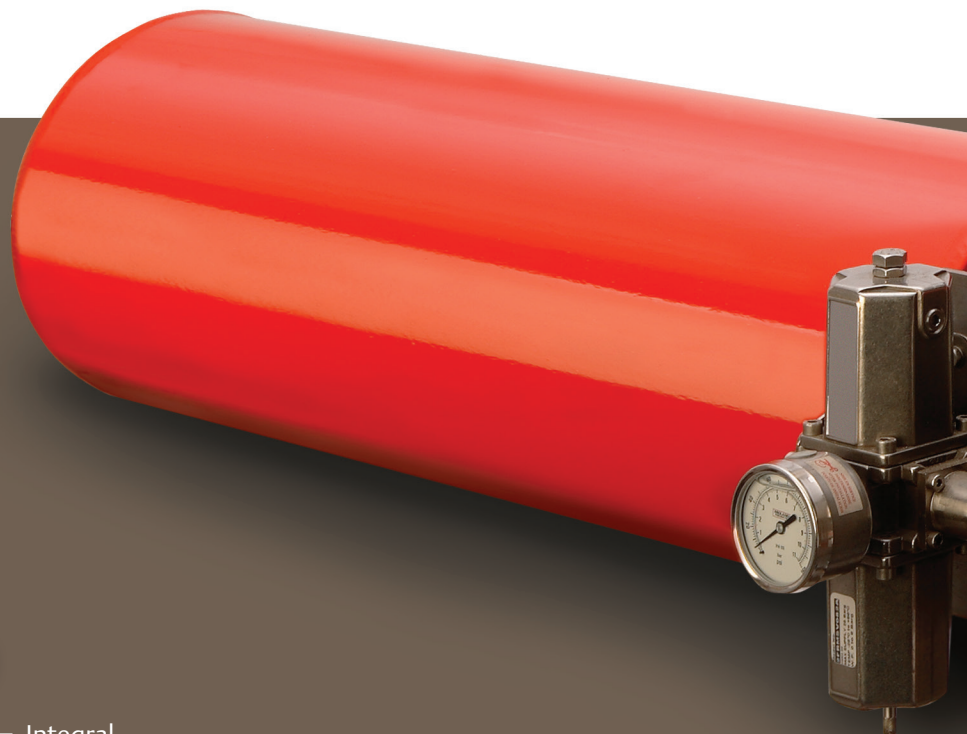

Available in three platforms suitable for your particular application:



DXP | Tropicalized Aluminum
Flameproof/Explosion Proof

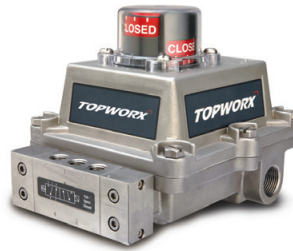

DXS | 316 Stainless Steel
Flameproof/Explosion Proof



DXR | Composite Resin
Non-Incendive

SIL-3
IEC 61508

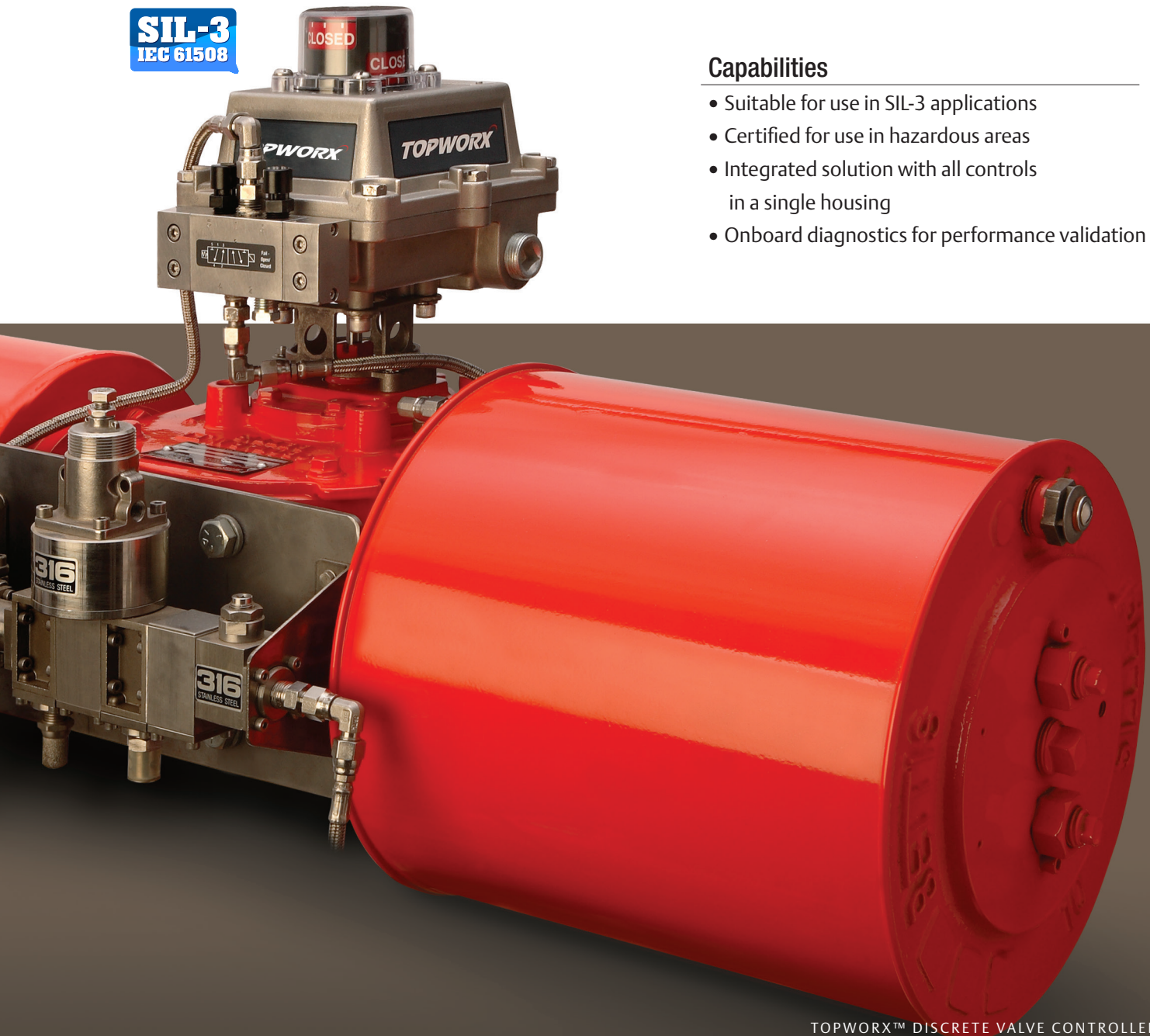

Capabilities

- Suitable for use in SIL-3 applications
- Certified for use in hazardous areas
- Integrated solution with all controls in a single housing
- Onboard diagnostics for performance validation

TOPWORX™ 4310

Wireless Position Monitor

No Wires, No Problem

Every plant has blind spots and hard-to-reach equipment. The TopWorx™ 4310 wireless position monitor sends a wireless feedback signal through the Smart Wireless network to indicate discrete valve position, device temperature, and power module status. This unobtrusive position monitor won't disturb your existing process wiring; no wires means the Smart Wireless network can be superimposed over any wiring infrastructure adding the ability to analyze rotary and linear valves and actuators; displacement, float level sensors; and regulators.

Minimize Process Upsets & Protect the Process

The 4310 wireless position monitor is ideal for applications for monitoring valve position feedback to isolate problem valves. You can minimize process upsets and keep your plant performing. This intrinsically safe device is suitable for use in all zone locations.

Eliminate Costly Mistakes

Errors can result in lost production and reprocessing costs. When you integrate valve alignment into the control logic, you can create automated process checks, in turn eliminating costly mistakes as well as compare value set points and process conditions to valve position feedback to isolate problem valves.

Wireless On/Off Control

Wireless Improves Plant Efficiency

Less time moving valves means more time to attend to scheduled tasks. Faster valve alignment means more time meeting your needs. Wireless allows you to automate process startup, shut down, and switch over procedures reducing Lost Batches, and increasing Capacity Automation. Automating the manually operated components of your process can eliminate troublesome sources of variability.

Wireless Improves Personnel Safety

Automating your plant can mean reducing your workers' exposure to hazardous environments and inclement weather. More efficient processes allow for more time to focus on reduction of costly mistakes.

Wireless Reduces Unwanted Emissions

Fill or transfer valves can be sources of excessive level, temperature, and pressure leading to unplanned downtime. Minimize the chances of a manual valve being the root cause of hazardous emissions by converting to wireless.

TopWorx™ 4310 Valve Automation Package

Package includes a 4310 controller, TRU-FLO 316 Stainless Steel Valve, EL-O-MATIC actuator, and mounting kit with skirt indicator. (Power module sold separately)

Valve Size	Actuator	Model#
1/2"	ES0025-U1A04 Failed Close	4310-4CC-005-VAP
3/4"	ES0025-U1A04 Failed Close	4310-4CC-075-VAP
1.0"	ES0025-U1A04 Failed Close	4310-4CC-100-VAP
1.25"	ES0025-U1A04 Failed Close	4310-4CC-125-VAP
1.5"	ES0025-U1A04 Failed Close	4310-4CC-150-VAP

TopWorx™ 4310 Valve Package

Package includes a 4310 indicator, TRU-FLO 316 Stainless Steel Valve manual valve, and ISO mounting kit (Power module sold separately)

Valve Size	Model#
1/2"	4310-4CC-005-VAP
3/4"	4310-4CC-075-VAP
1.0"	4310-4CC-100-VAP
1.25"	4310-4CC-125-VAP
1.5"	4310-4CC-150-VAP



Monitoring and Controlling Discrete Valves

Have manual valves in the wrong position led to a bad batch, harmful environmental release, or unsafe incident? How about discrete valves automated with a solenoid with no position feedback?

What if you could reliably control the valves and have accurate position feedback without the implementation of barriers and costs of wired automation?

What if you could have a single reliable solution provider for the Valve, Actuator, Mounting Accessories, and Wireless controller?

Where “Blind Valves” Needs Your Attention

- | | |
|----------|---|
| Fill | Increase reliability and eliminate sources of variability caused by inconsistent switch feedback from mechanical switches |
| Flush | Eliminate spills caused from flush valves left open by operations, or misalignments from mechanical switch feedback |
| Drain | Reduce impact on resources and delays in processing waiting on human resource availability |
| Transfer | Eliminate unwanted variables in the process caused by a lack of automation feedback and mechanical switch issues |

“Out of the Box” Solution

Emerson Process Management is positioned as a technology solutions provider to offer an easy to implement wireless automated valve package in standard valve sizes and configuration suited to your plant’s needs.

Emerson’s Smart Wireless Solution delivers these benefits easily and cost effectively using IEC approved WirelessHART™ technology.

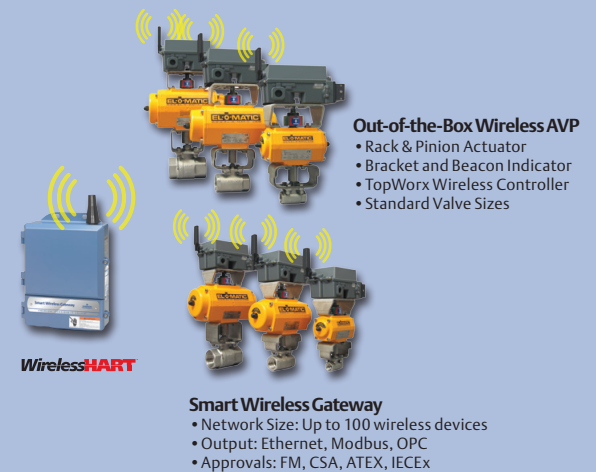

- Out-of-the-Box Wireless AVP**
- Rack & Pinion Actuator
 - Bracket and Beacon Indicator
 - TopWorx Wireless Controller
 - Standard Valve Sizes

- Smart Wireless Gateway**
- Network Size: Up to 100 wireless devices
 - Output: Ethernet, Modbus, OPC
 - Approvals: FM, CSA, ATEX, IECEx

TOPWORX™ APPLICATIONS

Valve Control Solutions for Every Application

4-20mA TRANSMITTERS WITH HART PROTOCOL



The 2-wire position transmitter with HART will generate a nominal 4-20mA signal proportional to valve position output for full-range actuation of the valve. The transmitter is capable of generating signals below 4mA and above 20mA if the position sensor indicates an out-of-range value. With the added HART digital communication capability, remote calibration and parameter configuration can be performed via a handheld.

Features:

- Remote set point calibration using a handheld device for calibration and monitoring
- Selectable over and under travel settings
- 4 to 20mA variable reading
- Monitoring and setting of alarms with advanced diagnostics. Includes deadband detection, out of range indication and detection of internal memory errors

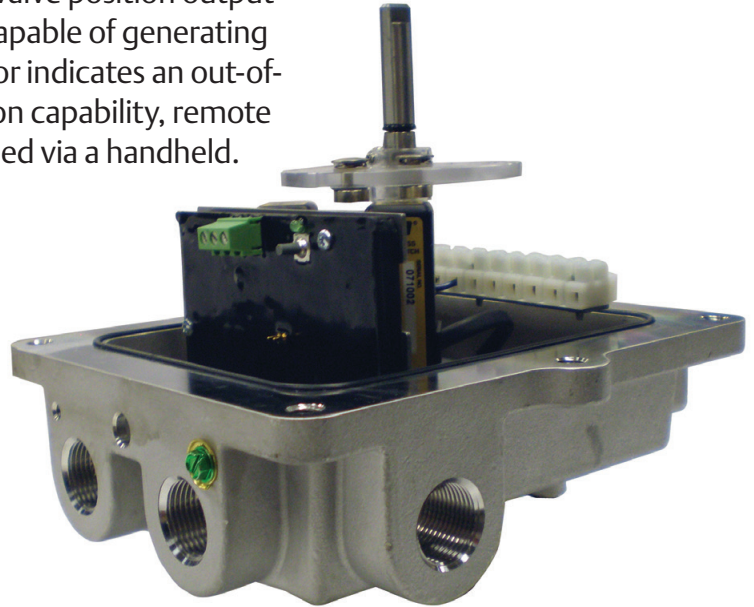

THE STAINLESS STEEL, 35-SERIES GO™ SWITCH

Hermetically-Sealed, Stainless Steel, DPDT Proximity Switch

For over fifty years, GO™ Switch, all in one proximity sensor and limit switches, have set the standard for reliability and durability in the process industries. Their unique operating principle and best-in-class capabilities have made them the most specified switch in the world for demanding process applications.

TopWorx™ has once again improved on greatness.

The 35-Series GO™ Switch is available in two versions: The original Single Pole Double Throw GO™ Switch or the stainless steel, Double Pole Double Throw, version.

Features:

- One-piece, stainless steel housing
- Hermetically-sealed, Double Pole Double Throw contacts
- Suitable for both Ex d and Intrinsically Safe applications
- Up to four (4) switches in a single enclosure
- Extremely low hysteresis
- PLC and higher current ratings with AC/DC - NO/NC wiring flexibility
- 4amp/120vac and 3amp/24vdc
- Available with SOV and HART options

GO Gets It.

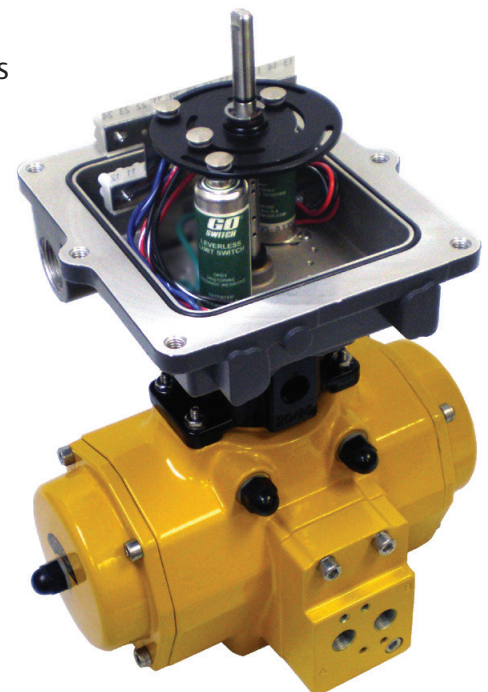

LINEAR VALVE MONITORS & SENSORS

TopWorx™ discrete valve controllers are the products of choice for linear valves of all types. Their precision sensing and proven reliability deliver the best position feedback available. Options such as 4-20mA transmitters with end-of-stroke sensors and HART protocol provide continuous monitoring and confirmation of valve position. Custom mounting kits are available to ensure reliable operation for the life of the valve package.



TopWorx™ D-Series on linear control valves

**DXP WITH IEC/ATEX IIC CERTIFICATION
The Only IIC Valve Controller with an Integral Solenoid.**

Most ATEX Ex d IIC valve controllers have small containers with screw-top lids and very few options. Often the threads on the screw-top lids bind up, causing safety issues on multiple levels. TopWorx™ is changing all of that with the IIC-certified DXP valve controller.

There is no competition.

The unique modular design of the TopWorx™ DXP discrete valve controller combines bus networking, pilot valve and position sensors into a globally certified, explosion proof enclosure that attaches to any automated valve package.

Features:

- Serrated Flange (No binding of threads)
- Improved ingress protection
- IECEx, ATEX, & Ex d Group IIC
- The only IIC Box with integral solenoid
- Available with all Bus & Sensor options!

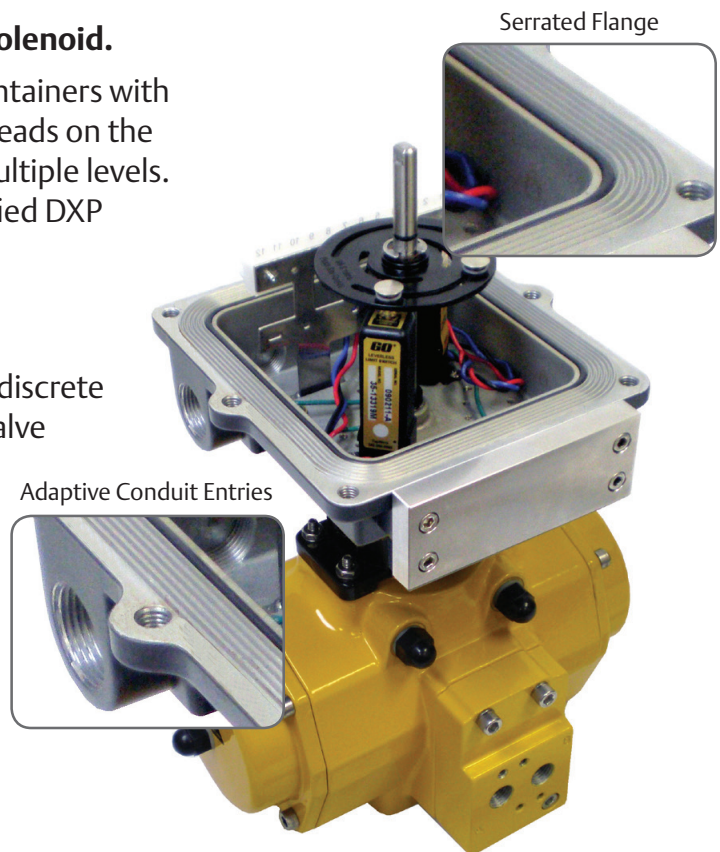

TOPWORX™ APPLICATIONS

Valve Control Solutions for Every Application

DUAL PILOT VALVE FOR DRIBBLE FEED CONTROL

By using a unique dual valve option, the solenoids can be configured to allow two stage closing of the valve for applications such as tank filling where the valve needs to be throttled to prevent overflowing.

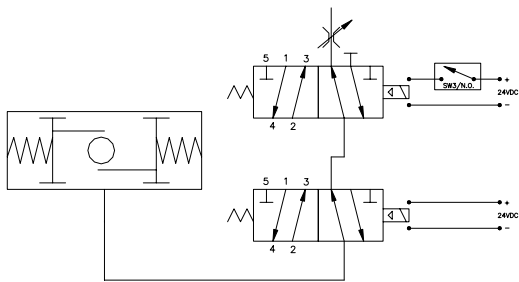

TOPWORX™ DXP WITH MANUAL RESET SOLENOID VALVE

The TopWorx™ DXP with Manual Reset is designed for critical service or emergency shutdown valve applications. It is ideal for oil & gas, chemical, or refining industries, which are often subject to strict safety regulations that require operators to manually verify a system prior to restarting a process.

The unique modular design of the DXP discrete valve controller combines bus networking, pilot valve and position sensors into a single, globally certified explosion-proof enclosure that attaches to any automated valve package. The Manual Reset solenoid valve features a 1.2 Cv and a rugged 316 stainless steel housing, which is ideal for offshore applications.

TOPWORX™ VISUAL INDICATORS

A variety of indicators to fit every application, including multiple color combinations such as Green/Red and Yellow/Black, plus three-way, 90° and 180° flow paths. Other languages are also available upon request.



COLD TEMP TO -60°C/-76°F

The TopWorx™ D-Series will give accurate position indication down to -60°C with the use of the GO Switch.



“ We replaced all of a competitor’s switchbox with the TopWorx™ DXP using GO Switches. We can set the DXPs and walk away from them knowing that they work great. ”

- **I&C Leader**, Japanese Chemical Company



“ The TopWorx™ product was attractive to us because the enclosure was resilient and able to survive in a hazardous and corrosive environment. ”

- **Process Engineer**, German Chemical Company

TOPWORX™ MOUNTING KITS

VIP™ Brackets to Fit Any Rotary Valve or Actuator



VIP MOUNTING KIT

TopWorx™ valve controllers can be mounted on any rack-n-pinion, scotch-yoke, or vane actuator, quarter-turn manual valves, linear knife-gate and control valves, and positioners. Visit www.topworx.com for a complete list of available kits or to request a custom design.

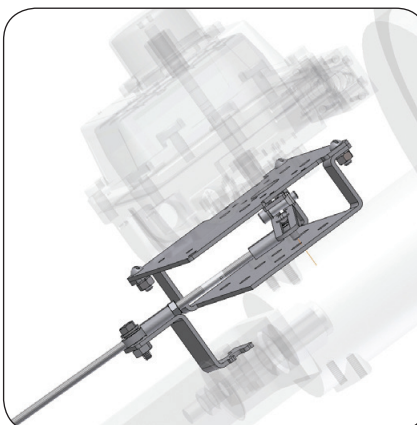
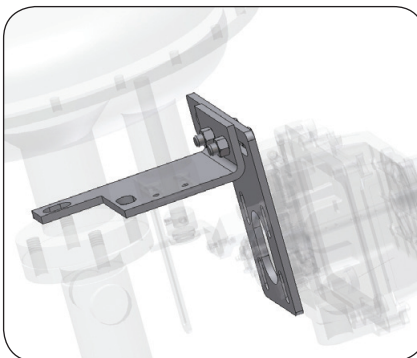
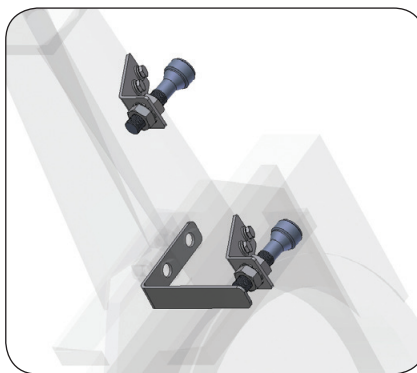
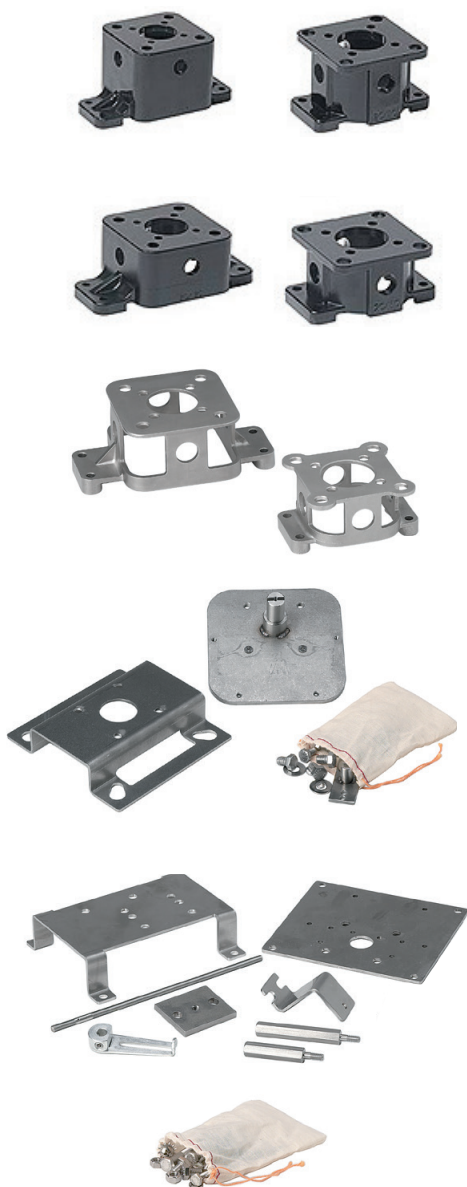

TopWorx™ offers thousands of mounting kits to fit a wide variety of valves and actuators. Each kit comes complete with a parts list and installation instructions.

- | | |
|----------------|------------------|
| 3Z Valve | Larox |
| Actreg | Ledeen |
| Airtorque | MAGNETROL |
| ANCHOR DARLING | Marwin |
| Apollo | Masoneilan |
| Automax | Mogas |
| AXELSON | Neles-Jamesbury |
| Baumann | Neway |
| Bettis | Newcon Valve |
| Biffi | Orbinox |
| Bray | Orbit |
| BROOKS BRODIE | PBM |
| Cameron | PBV |
| CCI | Poyam |
| ChemValve | Protech |
| Clarkson | PVC |
| Compaq | QTRCO |
| Conbraco | Radius |
| Contromatics | RCS |
| COPES VULCAN | Remote Control |
| Crane | RF Technologies |
| DeZurik | Rhino |
| Durco | Rotork |
| El-O-Matic | SAMSON |
| Fabri Valve | Severn Glocon |
| Fisher | SPEAKMAN |
| Flowbus | TBV |
| Flowserve | Triac |
| General Valve | Trutorq |
| Grinnell | Unitorq |
| HAWS | Valtek |
| HONEYWELL | Valvtechnologies |
| Hytork | Vanessa |
| ITT | Velan |
| KENNETH ELLIOT | VTI |
| Keystone-Morin | Watts |
| Kinetrol | WKM |
| Kitz | Worcester |
| KTM | Xomox-Matryx |
| KTM | |

TOPWORX™ TECHNICAL INFORMATION

Dimensional Drawings, Electrical Ratings

D-SERIES DIAGRAMS

DXP

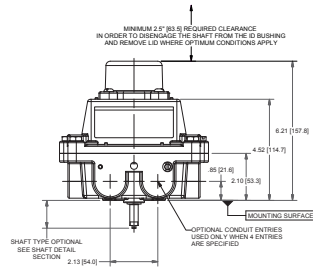

DXR

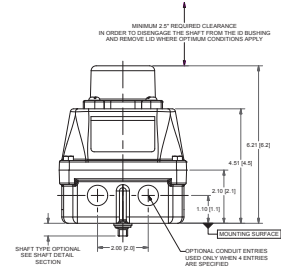

DXS

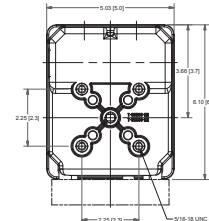
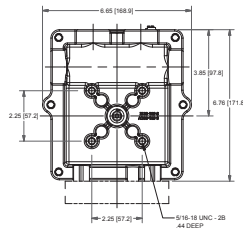
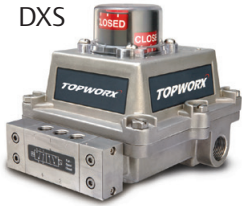

T-SERIES DIAGRAMS

TVA

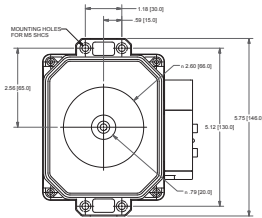
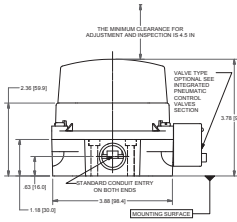

TXS

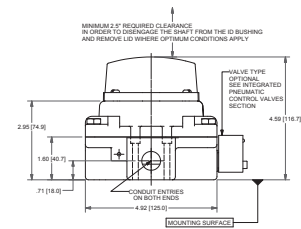

TXP

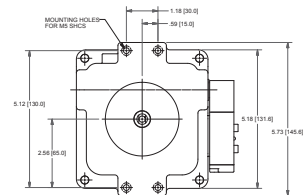
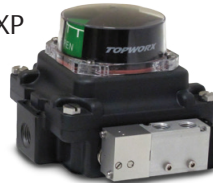

TVH

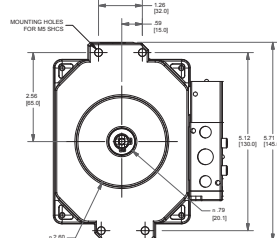
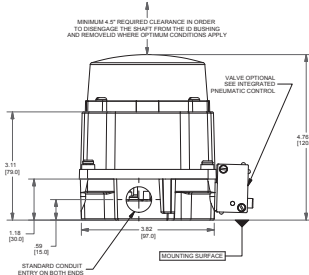

TVF

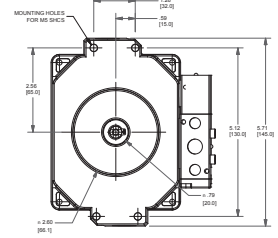
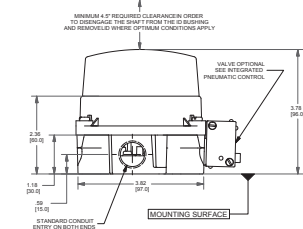
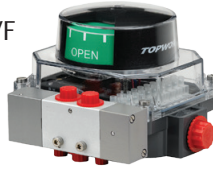

TVL

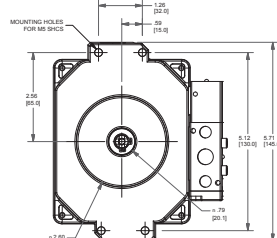

DRY-CONTACT POSITION SENSORS

Electrical ratings:

- L (GO Switch): 4amp/120vac, 3amp/24vdc
- P (Hi-Amp Prox): 3amp/120vac, 2amp/24vdc
- R (Low-Amp Prox): .2amp/30vdc
- M (Mechanical Switch) 15A/120vac
- _X (4-20mA Transmitter) 8.5-34vdc
- D-Series available with 12pt. terminal strip
- TV-Series available with 12pt terminal strip when only switches are used and 10pt terminal strip when internal solenoid is specified
- T-Series available with 8pt. terminal strip

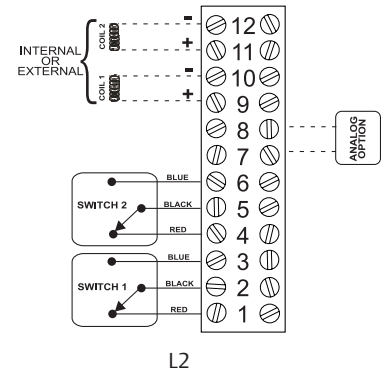
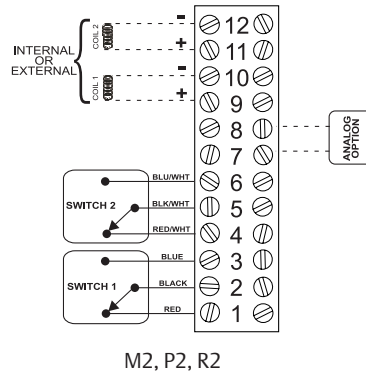

INDUCTIVE PROXIMITY SENSORS

- Available with all types of inductive proximity sensors, including Pepperl & Fuchs™, IFM™, and Turck™
- 3-Wire PNP/NPN:
 - : Voltage: 10-30vdc
 - : Power Consumption: 15mA
 - : Operating Current: 0- 200mA
- 2-Wire N/O & N/C
 - : Voltage: 5-250vac/vdc
 - : Power Consumption <0.5mA
 - : Operating Current: 0- 200mA
- Namur Output:
 - : 8vdc
 - : Current consumption:
 - : Switched: <1mA
 - : Unswitched: >3mA

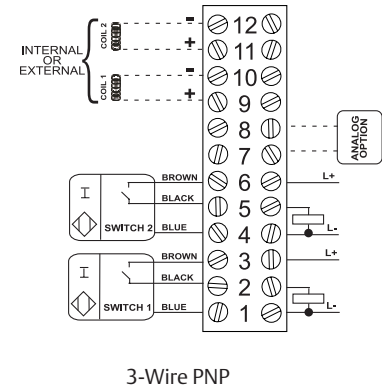
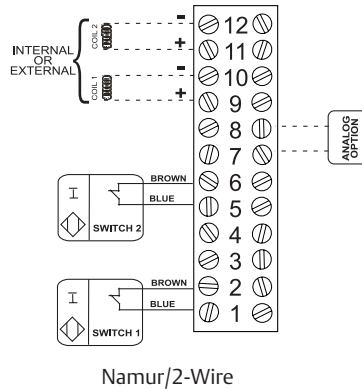

SOLENOID VALVES

Pressure rating: 30-100psi (2 - 8 bar)

Temperature rating:

- Standard -20°C to +60°C
- Standard Piezo: -20°C to +60°C

Power consumption:

- Standard: 0.5Watts
- Piezo: 12mWatts

Voltages:

- 12/24vdc
- 110vac
- 220vac

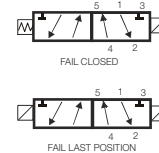
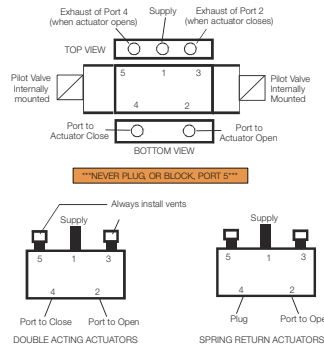

TOPWORX™ D-SERIES, DXP, DXR, DXS ORDERING GUIDE

Choose one option from each category to build a complete model number.
Consult factory for options not shown below.

Enclosure

- DXP** Tropicalized Aluminum
- DXR** Composite Resin ("S" Silicone O-Rings only; Stainless steel conduit entries required for North American Approvals) (Area Classification "0" only available with ATEX/IECEx approvals)
- DXS** 316 Stainless steel (Only available with "R" or "M" shaft options)

Bus/Sensor

- Bus Network**
AS AS-Interface (Area class cannot be 0)
FF FOUNDATION Fieldbus w/ 0 - 10K Pot
FL Foundation Fieldbus w/(2) SPDT GO Switches
FP Foundation Fieldbus w/(2) SPDT GO Switches and 0-10K Pot
DN DeviceNet (Area class cannot be 0)
- Partial Stroke Test**
ES ESD/PST Module w/GO Switch (Area class cannot be 0 or 2)
- GO Switches**
L2 (2)GO Switches SPDT hermetic seal
L4 (4)GO Switches SPDT hermetic seal
Z2 (2)GO Switches DPDT hermetic seal
Z4 (4)GO Switches DPDT hermetic seal
- Mechanical Switches**
 (Area class cannot be 2 or DXR with G)
M2 (2)Mech SPDT
M4 (4)Mech SPDT
M6 (6)Mech SPDT
T2 (2)Mech DPDT
K2 (2)Mech SPDT gold contacts
K4 (4)Mech SPDT gold contacts
- Proximity Switches**
PN (2) SPDT Module w/o LED's, 1A max
PS (2) SPDT Module w/LED's, 250mA max (R2 and R4 only available with DXR and Ex me certification)
R2 (2) SPDT Prox switches
R4 (4) SPDT Prox switches
- Inductive Sensors**
E2 (2) p+f NJ2+V3-N inductive NAMUR
E4 (4) p+f NJ2+V3-N inductive NAMUR
- Analog Output**
 (Available with 2-switch options only for L,Z,M,K,E,T)
_X 4-20mA transmitter
_H 4-20mA transmitter with HART (Not available with switch option T; LH not available w/pilot valve) (LH, ZH Not available with DXR)
- Examples:**
LX = (2) GO Switches with transmitter
0X = 4-20mA transmitter with no switches
LH = (2) GO Switches with HART transmitter

Area Classification

- 0** Intrinsically safe (Bus/sensor cannot be AS, DN, ES; Requires appropriate I.S. barrier)
 - North America Class I Div 1&2 Groups A, B, C, D Type 4, 4X
 - ATEX/IECEx Zone 0 II1G, II2D, II2GD, T6/T4 Ex ia IIC Ex tb IIIC, IP66/67
- 1** Explosion proof / Flame proof (DXP/S only)
 - North America Class I Div 1&2 Groups C, D; Class I Div 2, Groups A, B, C, D. (Groups A & B must be hermetically sealed) Type 4, 4X
 - ATEX/IECEx Zone 1 II2G, II2GD, T6/T4/T3 Ex d IIB+H2 Ex tb IIIC IP66/67 (O-Rings must be S or E for DUST certification)
- 2** Non-incendive (Bus/sensor must be L, Z, P, AS, FF or DN)
 - North America Class I Div 2 Groups A, B, C, D; Class II Div 2 Groups F,G
 - ATEX (DXP/S only) II3G, Ex nAnC IIC; Ex tc IIIC, IP66/67 (O-Rings must be S for DUST certification)
- G** General Purpose Type 4, 4X (not available with DXR with mechanical switches)
- C** Flameproof (DXP only; Conduit entries must be E or M) ATEX/IECEx II2G, II2GD, T6/T4/T3 Ex d IIC Ex tb IIIC IP66/67
- M** Flameproof (only available with R2 and R4 sensor) (DXR only) ATEX/IECEx Sone 1, IIGD Ex e mb IIC T4, Ex tb IIIC T66 IP67
- W** No approvals Type 4X, IP66/68

For complete information on certification options, go to www.topworx.com and download the applicable product certificate.

Visual Display

- G** Standard 90° Green OPEN, Red CLOSED
- B** 90° Black OPEN, Yellow CLOSED
- Y** 90° Yellow OPEN, Black CLOSED
- 1** 3 way, 90° L Port
- 3** 3 way, 90° T Port
- 5** 3 way, 90° T Port
- 7** 3 way, 180° T Port 3 position
- 9** 3 way, 180° T Port 3 position

Shaft

- S** 1/4" DD 304 stainless steel
- N** NAMUR 304 stainless steel
- R** 1/4" DD 316 stainless steel (Shaft & external hardware)
- M** NAMUR 316 stainless steel (Shaft & external hardware)

Conduit Entries

- DXP/DXS (Metal Conduit Entries)**
E (2) 3/4" NPT
- 4** (2) 3/4" NPT (2) 1/2" NPT
- M** (2) M20
- 3** (4) M20
- 6** (4) 3/4" NPT
- DXR (Stainless Conduit Entries Required for North American approval)**
P (2) 1/2" NPT
- E** (2) 3/4" NPT
- M** (2) M20
- DXR (Resin Conduit Entries)**
A (2) 1/2" NPT
- B** (2) 3/4" NPT
- C** (2) M20

Ordering Guide
Fill in the boxes to create your 'ordering number.'

Enclosure

Bus/Sensor

Area Classification

Visual Display

Shaft

Conduit Entries

Ordering Examples:
DXP-FF0GNEBPA2
DXP-L21GNEB1A2

O-Rings	Pilot	Spool Valve	Valve Cv	Manual Override	Regional Certs
<p>B Buna-N</p> <p>S Silicone</p> <p>NOTE: For Temperatures below -40°C, Silicone o-rings are recommended</p>	<p>Blank No pilot device(s)</p> <p>1 (1) 24 Vdc pilot, fail open/closed 0.5 W (non-I.S.) 0.7W (I.S.)</p> <p>2 (2) 24 Vdc pilots, fail last position 0.5W (non-I.S.) 0.7W (I.S.)</p> <p>4 (1) 220 Vac pilot, 2W, fail open/closed</p> <p>5 (2) 220 Vac pilots, 2W, fail last position</p> <p>7 (1) 110 Vac pilot, 1.1W, fail open/closed</p> <p>8 (2) 110 Vac pilots, 1.1W, fail last position</p> <p>P (1) piezo pilot, fail open/closed (FF only)</p> <p>R (2) piezo pilots, fail last position (FF only)</p>	<p>Blank No Spool Valve</p> <p>A Aluminum Hard coat anodized</p> <p>6 316 Stainless steel</p>	<p>Blank No Spool Valve</p> <p>2 1.2 Cv (1/4" NPT Ports)</p> <p>3 3.0 Cv (1/2" NPT Ports) (For manual override consult factory) (Spool Valve A) (Spool Valve 6)</p>	<p>Blank No override</p> <p>1 Single Pushbutton Momentary/Latching</p> <p>2 Dual Pushbutton Momentary/Latching</p> <p>T Partial stroke test button with lockable cover (Sensor ES only) (Not avail w/ Area Class C) (DXP/S - Conduit Entries 4 or 3 only. DXR - consult factory)</p>	<p>Blank No Regional Cert</p> <p>B InMetro</p> <p>N NEPSI (DXP/S only)</p> <p>F FISCO (Bus/Sensor must be FF; Area Class must be 0)</p> <p>K KOSHA (DXP/S only) (Area class I or C)</p> <p>R EAC (DXP/S only) (O-Ring must be B or S; B=Gas Approved; S= Gas/Dust Approved)</p> <p>A ANZEx Ex d IIC, Ex d IIB+H2 (DXP/S only)</p> <p>P PESO (India)</p>
O-Rings	Pilot	Spool	Valve Cv	Override	Regional Certs

TOPWORX™ ACCESSORIES

Description	Part Number
Pneumatic Accessories	
Flow Control, 1/4" NPT (1 per kit) (DXP/TXP/TVA)	AL-M21
Flow Control, 1/2" NPT (1 per kit) (DXP w/3.0Cv spool valve)	AL-M22
Breathers, 1/4" NPT (2 per kit) (DXP)	AL-M31

TOPWORX™ T-SERIES, TXP, TXS, TVA ORDERING GUIDE

Choose one option from each category to build a complete model number.
Consult factory for options not shown below.

Enclosure

TXP Tropicalized Aluminum

TXS 316 Stainless Steel

TVA Engineered Resin
(Area Class must be W or 0)

! TVA and TXP mounting accessories now sold separately. See listing below for kit #s and description.

Bus/Sensor

Bus Network

AS AS-Interface

(Area class cannot be 0)

PB Profibus DP

(Area class must be 1, C or W)

Mechanical Switches

(Area class cannot be 2)

M2 (2) Mech SPDT

M4 (4) Mech SPDT

K2 (2) Mech SPDT w/gold contacts

T2 (2) Mech DPDT

Proximity Switches

R2 (2) SPDT 200mA max

R4 (4) SPDT 200mA max

P2 (2) SPDT 3A max

GO Switches

L2 (2) GO Switches SPDT hermetically sealed (TXP/TXS w/ no pilot valve only)

Inductive Sensors

E2 (2) p+f NJ2+V3-N inductive NAMUR

I2 (2) Ind prox PNP N/O (Area class cannot be 0)

Analog Output

(Available only with TXP and TXS)
OX 4-20mA
Transmitter with no switches

Examples:

AS = AS-i with "R" type reed switches

AM = AS-i with "M" type mech switches

Area Classification

0 Intrinsically safe
ATEX/IECEX
Zone 1
II2GD Ex ia IIC
Ex tb IIIC, IP66/67 (TXP/S only)
II2G Ex ia IIC, T4 (TVA only)

C Flame Proof (TXP & TXS w/o pilot valve only)
ATEX/IECEX
II2GD Ex d IIC
Ex tb IIIC, IP66/67

1 Flame proof (TXP & TXS only)
Cl I Div 1 Grps C,D
Cl II Div 1 Grps E-G
ATEX/IECEX
Zone 1
II2GD Ex d IIB
Ex tb IIIC, IP66/67

2 Non-incendive (TXP/TXS only)
Cl I Div 2 Grps A-D
Cl II Div 2 Grps F&G
ATEX II3GD (Not available with all sensing options)
Ex nA nC IIC, IP66/67
Ex tc IIIC

G General Purpose (TXP/TXS only)
Type 4X

W No approvals
IP66/68

Visual Display

G Standard 90°
Green OPEN,
Red CLOSED

B 90° Black OPEN,
Yellow CLOSED

F Flat-top with skirt indicator (TXP & TXS only) (Indicator not provided with "L" Shaft option)

Y 90° Yellow OPEN,
Black CLOSED

J 3 Way T Port,
Green/Red

K 3 Way L Port,
Green/Red

Shaft

N NAMUR
304 stainless steel

L 1" Extended
Linear Shaft
(TXP/TXS only)

Conduit Entries

TXP/TXS

P (2) 1/2" NPT

M (2) M20

E (2) 3/4" NPT
(Not available with pilot valve)

3 (4) M20
(Not available with pilot valve)

4 (2) 3/4" NPT
(2) 1/2" NPT
(Not available with pilot valve)

TVA

A (2) 1/2" NPT
Resin

C (2) M20 Resin

For complete information on certification options, go to www.topworx.com and download the applicable product certificate.

Ordering Guide

Fill in the boxes to create your 'ordering number.'

Enclosure

Bus/Sensor

Area Classification

Visual Display

Shaft

Conduit Entries

Ordering Examples:
 TXS-ASCGNPM1A1
 TXP-M21GNPB1A1

O-Rings	Pilot	Spool Valve	Valve Cv	Manual Override	Regional Certs
M Silicone	Blank No pilot device(s) 1 (1) 24Vdc pilot, fail open/closed 1W (non I.S) 0.7 W (I.S) 7 (1) 110Vac pilot, 3VA, fail open/closed 4 (1) 220Vac pilot, 3VA fail open/closed	Blank No spool valve A Aluminum Hard coat anodized 6 316 Stainless steel <div style="border: 1px solid black; border-radius: 10px; padding: 5px; text-align: center; margin: 10px 0;"> Don't Forget! </div> Filtered air is required for proper valve operation. Reference www.topworx.com for additional Air Filter information.	Blank No spool valve 1 1.0 Cv (1/4" NPT Ports) 8 1.0 Cv (1/4" BSP Ports)	Blank No override 1 Single Pushbutton Momentary/Latching	Blank No Regional Cert N NEPSI R EAC (TXP/S only) B InMetro P Peso
O-Rings	Pilot	Spool	Valve Cv	Override	Regional Certs

T-SERIES MOUNTING KITS

Description	Part Number	Description	Part Number
<u>Resin Mounting Kits for TVA</u>		<u>Stainless Steel Mounting Kits for TXS</u>	
Mounting Kit for 20 x 80	AL-TR01	Non-NAMUR Interface Kit	Z001205
Mounting Kit for 30 x 80	AL-TR04	Mounting Kit for 20 x 80	AV-TS09
Mounting Kit for 30 x 130	AL-TR07	Mounting Kit for 20 x 80 (flattop only)	AV-TS10
Mounting Kit for 50 x 130	AL-TR09	Mounting Kit for 30 x 80	AV-TS11
<u>Mounting Kits for TXP</u>		Mounting Kit for 30 x 80 (flattop only)	AV-TS12
Mounting Kit for 20 x 80	AV-TA09	Mounting Kit for 30 x 130	AV-TS13
Mounting Kit for 20 x 80 (flattop only)	AV-TA10	Mounting Kit for 30 x 130 (flattop only)	AV-TS14
Mounting Kit for 30 x 80	AV-TA11	Mounting Kit for 50 x 130	AV-TS15
Mounting Kit for 30 x 80 (flattop only)	AV-TA12	Mounting Kit for 50 x 130 (TXS flattop only)	AV-TS16
Mounting Kit for 30 x 130	AV-TA13		
Mounting Kit for 30 x 130 (flattop only)	AV-TA14		
Mounting Kit for 50 x 130	AV-TA15		
Mounting Kit for 50 x 130 (flattop only)	AV-TA16		

TOPWORX™ T-SERIES, TVF, TVL, TVH ORDERING GUIDE

Choose one option from each category to build a complete model number.
Consult factory for options not shown below.

Enclosure

TVF Tropicalized Aluminum base with clear resin lid

TVL Tropicalized Aluminum base and Lid

TVH 316 Stainless Steel base and lid

Bus/Sensor

Bus Networks
(area class cannot be 0)
AS AS-Interface
DN DeviceNet
PB Profibus DP

Mechanical Switches
(Area class cannot be 2)
M2 (2) Mech SPDT
M4 (4) Mech SPDT
K2 (2) Mech SPDT w/
gold contacts
T2 (2) Mech DPDT

Proximity Switches
R2 (2) SPDT 200mA max
R4 (4) SPDT 200mA max
P2 (2) SPDT 3A max

Inductive Sensors
E2 (2) p+f NJ2+V3-N
inductive NAMUR

Analog Out
(Available with M, K, T, E)
_X 4-20 mA Transmitter

Area Classification

0 Intrinsically safe
ATEX/IECEX Zone 1
II2GD Ex Ia IIC
Ex tb IIIC; IP66/68 (Dust
groups TVL/TVH only)
CI I Div 1, Grps A-D,
CI II Div 1 Grps E-G

2 Non-incendive
ATEX/IECEX Zone 2
(TVL-TVH only)
II3GD Ex nA nC IIC
Ex tc IIIC, IP66/68
CI I Div 2 Grps A-D;
CI I Div 2 Grps F & G

G General Purpose
Type 4X

W No approvals
IP66/68

Visual Display

G Standard 90°
Green OPEN,
Red CLOSED

B 90° Black OPEN,
Yellow CLOSED

F Flat-top with skirt
indicator
(TVL & TVH only)
(Indicator not provided
with "L" Shaft option)

Y 90° Yellow OPEN,
Black CLOSED

J 3 Way T Port,
Green/Red

K 3 Way L Port,
Green/Red

Shaft

N NAMUR
304 stainless steel

L 1" Extended
Linear Shaft
(TVL/TVH only)

Conduit Entries

P (2) 1/2" NPT

M (2) M20

E (2) 3/4" NPT

1 (2) M25

Ordering Guide

Fill in the boxes to create
your 'ordering number.'

Enclosure

Bus/Sensor

Area Classification

Visual Display

Shaft

Conduit Entries

For complete information
on certification options,
go to www.topworx.com
and download the
applicable product
certificate.

Ordering Examples:
TVF-M20GNPM1A1
TVL-R4WGNPM

O-Rings	Pilot	Spool Valve	Valve Cv	Manual Override	Regionals
<p>M Silicone</p>	<p>Blank No pilot device(s)</p> <p>1 (1) 24Vdc pilot, fail open/closed 1W (non I.S.) 0.7 W (I.S.)</p> <p>2 (2) 24Vdc pilots fail last position 1W (non-I.S.) 0.7 W (I.S.)</p> <p>4 (1) 220Vac pilot, 3VA fail open/closed</p> <p>5 (2) 220Vac pilots, 3VA fail last position</p> <p>7 (1) 110Vac pilot, 3VA, fail open/closed</p> <p>8 (2) 110Vac pilots, 3VA fail last position</p>	<p>Blank No spool valve</p> <p>A Aluminum Hard coat anodized</p> <p>6 316 Stainless steel</p>	<p>Blank No spool valve</p> <p>1 1.0 Cv (1/4" NPT Ports)</p> <p>8 1.0 Cv (1/4" BSP Ports)</p>	<p>Blank No override</p> <p>1 Single Pushbutton Momentary/Latching</p>	<p>Blank No regionals</p> <p>N NEPSI</p> <p>B InMetro (Ex ia only)</p>
O-Rings	Pilot	Spool	Valve Cv	Override	Regionals

T-SERIES MOUNTING KITS

Description	Part Number	Description	Part Number
Mounting Kits for TVF/TVL		Stainless Steel Mounting Kits for TVH	
Mounting Kit for 20 x 80	AV-TA01	Non-NAMUR Interface Kit	Z001205
Mounting Kit for 20 x 80 (flattop only)	AV-TA02	Mounting Kit for 20 x 80	AV-TS01
Mounting Kit for 30 x 80	AV-TA03	Mounting Kit for 20 x 80 (flattop only)	AV-TS02
Mounting Kit for 30 x 80 (flattop only)	AV-TA04	Mounting Kit for 30 x 80	AV-TS03
Mounting Kit for 30 x 130	AV-TA05	Mounting Kit for 30 x 80 (flattop only)	AV-TS04
Mounting Kit for 30 x 130 (flattop only)	AV-TA06	Mounting Kit for 30 x 130	AV-TS05
Mounting Kit for 50 x 130	AV-TA07	Mounting Kit for 30 x 130 (flattop only)	AV-TS06
Mounting Kit for 50 x 130 (flattop only)	AV-TA08	Mounting Kit for 50 x 130	AV-TS07
		Mounting Kit for 50 x 130 (TXS flattop only)	AV-TS08

MULTIPLE APPLICATIONS. ALL CONDITIONS. ONE SOLUTION.



GO™ Switch models 11, 21, 31 and 81 are the ideal replacements for traditional mechanical limit switches. Sealed contacts, rugged housings, non-contact detection of ferrous metal & magnetic targets, and snap action response make these switches the ultimate problem solvers for troublesome mechanical limit switch applications.

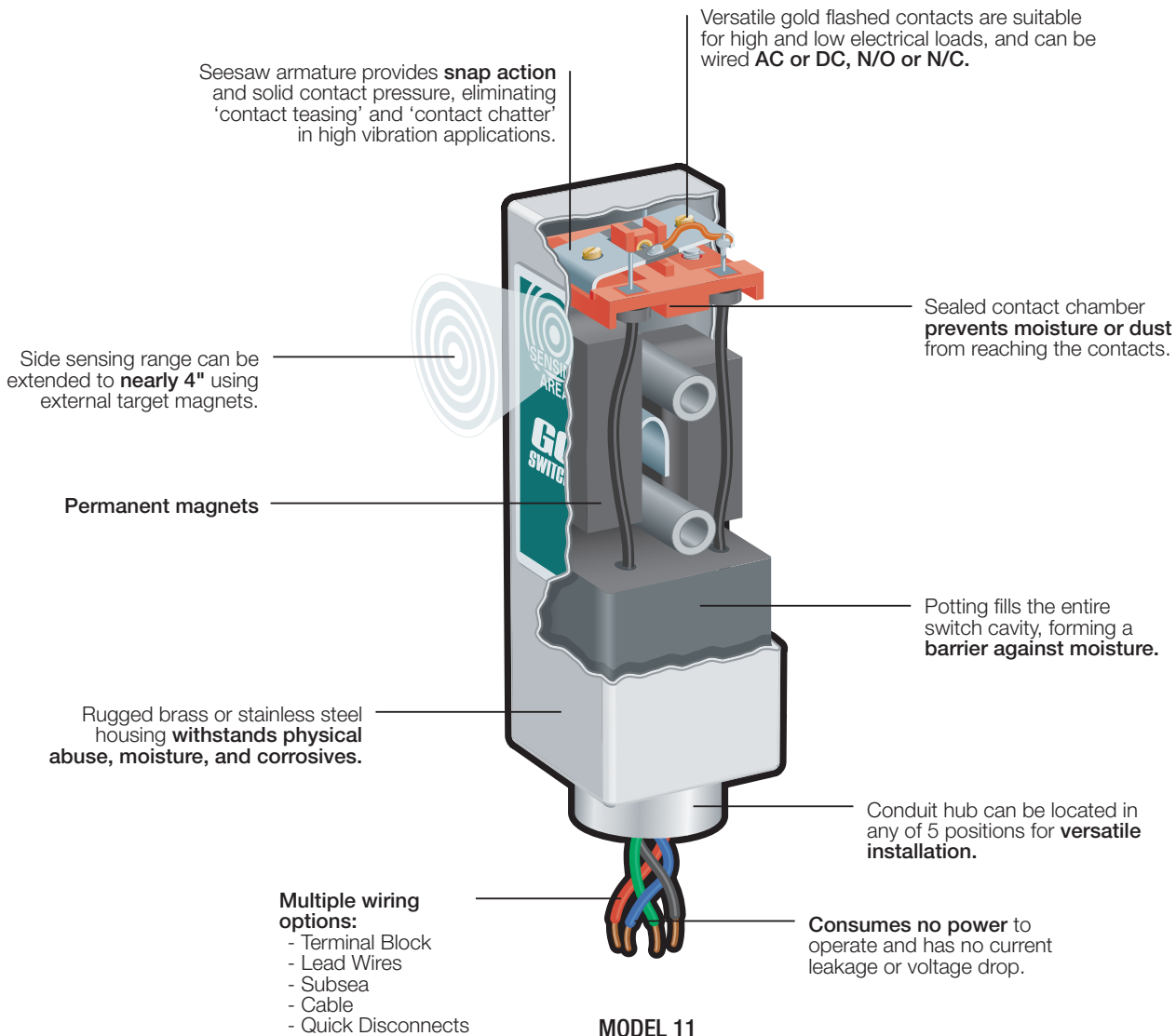
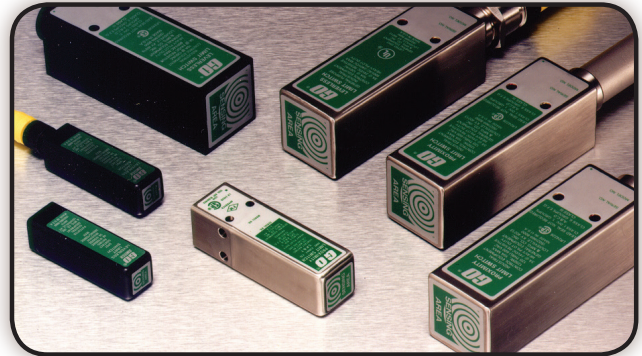

ENGINEERED TO OUTPERFORM

GO Gets It. **GO SWITCH**

With all stainless steel construction, flexible AC/DC, NO/NC, and SPDT/DPDT contact configurations, superior corrosion resistance, and global certifications for all hazardous areas, 70 Series GO Switches outperform inductive proximity switches in the toughest applications.

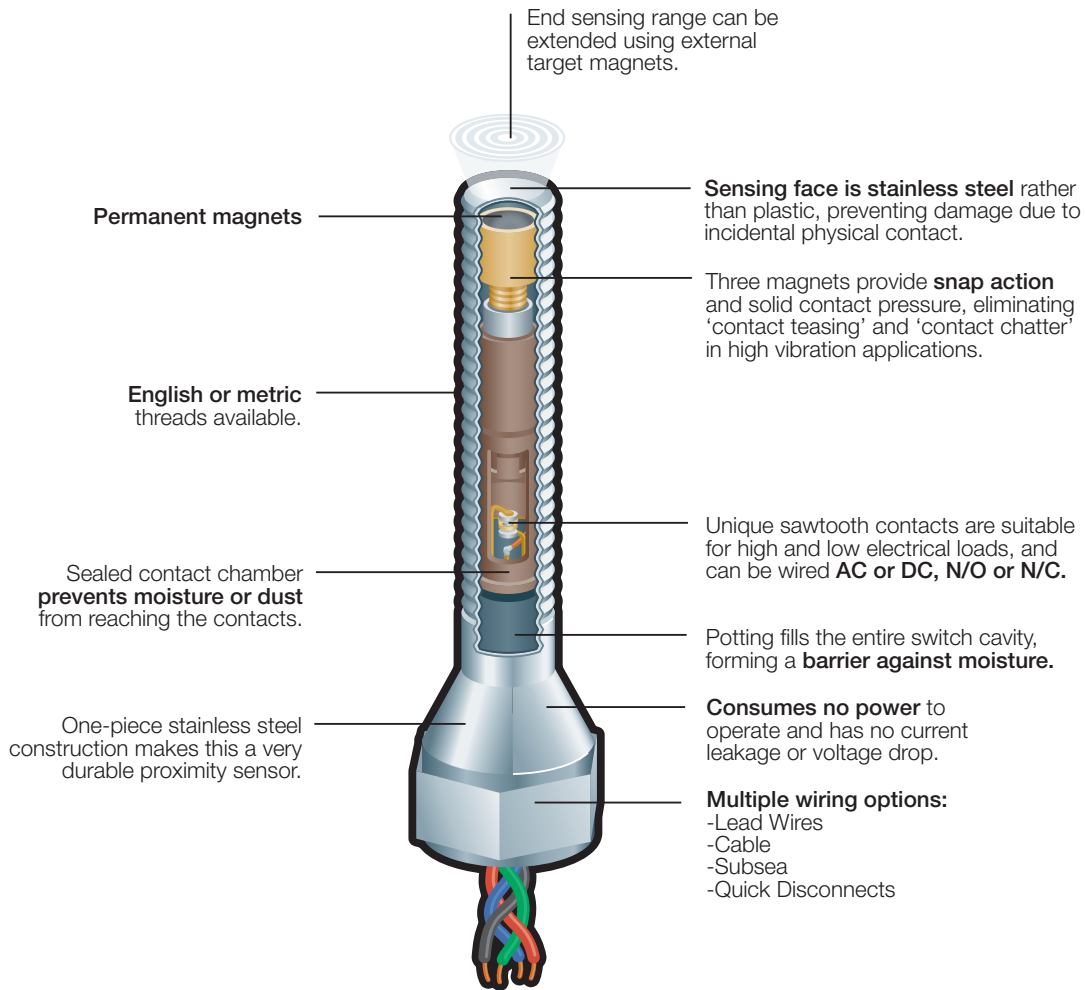

MODEL 73

GLOBAL SUPPORT OFFICES

Americas

3300 Fern Valley Road
Louisville, Kentucky 40213 USA
+1 502 969 8000
info.TopWorx@Emerson.com

Asia-Pacific

1 Pandan Crescent
Singapore 128461
+65 6891 7550
info.TopWorx@Emerson.com

Europe

Horsfield Way
Bredbury Industrial Estate
Stockport SK6 2SU
United Kingdom
+44 0 161 406 5155
info.TopWorx@Emerson.com

Middle East

P.O. Box 17033
Jebel Ali Free Zone
Dubai 17033
United Arab Emirates
+971 4 811 8283
info.TopWorx@Emerson.com

Africa

24 Angus Crescent
Longmeadow Business Estate East
Modderfontein
Gauteng
South Africa
+27 11 451 3700
info.TopWorx@Emerson.com

Visit www.topworx.com comprehensive information on our company, capabilities, and products – including model numbers, data sheets, specifications, dimensions, and certifications.

www.topworx.com

© 2015 TopWorx. All rights reserved. TopWorx™, GO Switch, VIP and Leverless Limit Switch are all trademarks of TopWorx™. The Emerson logo is a trademark and a service mark of Emerson Electric. Co.

© 2015 Emerson Electric Company. All other marks are the property of their respective owners. Information herein – including product specifications – is subject to change without notice.

GO
SWITCH

TOPWORX

About Emerson Process Management

Emerson Process Management is a powerful, global, single source of process improvement technology and expertise. We help major companies in selected industries optimize their plants and processes to achieve higher quality, greater reliability and faster time to market, while steadily advancing productivity and profitability. We can build it – providing experienced project management, engineering and a single point of accountability for the entire instrumentation and automation system. We can connect it – seamlessly integrating people and technology at every level of the process. We can improve it – creating more efficient utilization of energy and raw materials. And we can sustain it – producing greater reliability, month after month, year after year. From the field, to the plant, to the bottom line – where performance is the question, Emerson is the answer.

EMERSON
Process Management